

Panasonic

2.4GHz Cordless Phone

Model No. **KX-TG2553B**
KX-TG2553F
KX-TG2553S

Pulse-or-tone dialing capability

Operating Instructions



KX-TG2553B

Caller ID Compatible

PLEASE READ BEFORE USE AND SAVE.

Charge the battery for about 6 hours before initial use.

Panasonic World Wide Web address: <http://www.panasonic.com>
for customers in the USA or Puerto Rico

Preparation

Basic Operation

Advanced Operation

Useful Information

Before Initial Use

Please read **IMPORTANT SAFETY INSTRUCTIONS** on page 55 before use.
Read and understand all instructions.

Thank you for purchasing your new Panasonic cordless telephone.

Caller ID and Call Waiting Service, where available, are telephone company services. After subscribing to Caller ID, this phone will display a caller's name and phone number. Call Waiting Caller ID, which displays a second caller's name and phone number while the user is on another call, requires a subscription to both Caller ID and Call Waiting.

Attach your purchase receipt here.

For your future reference

Serial No. _____
(found on the bottom of the unit)

Date of purchase _____

Name and address of dealer _____

Accessories (included) For extra orders, call 1-800-332-5368.

- AC Adaptor (p. 11)
Order No. PQLV1Z

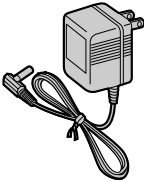

one

- Telephone Line Cord
(p. 11)

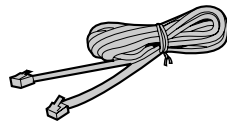

one

- Wall Mounting Adaptor (p. 46)
Order No. PQKL10038Z3

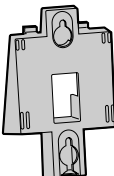

one

- Belt Clip (p. 48)
Order No. PQKE10127Z1

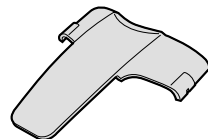

one

For Best Performance

Battery Charge

A rechargeable Ni-Cd battery powers the handset. Charge the battery for about **6 hours** before initial use (p. 12).



Base Unit Location/Noise

Calls are transmitted between the base unit and the handset using wireless radio waves. **For maximum distance and noise-free operation**, the recommended base unit location is:

Away from electrical appliances such as a TV, personal computer or another cordless phone.

In a **HIGH** and **CENTRAL** location with no obstructions such as walls.

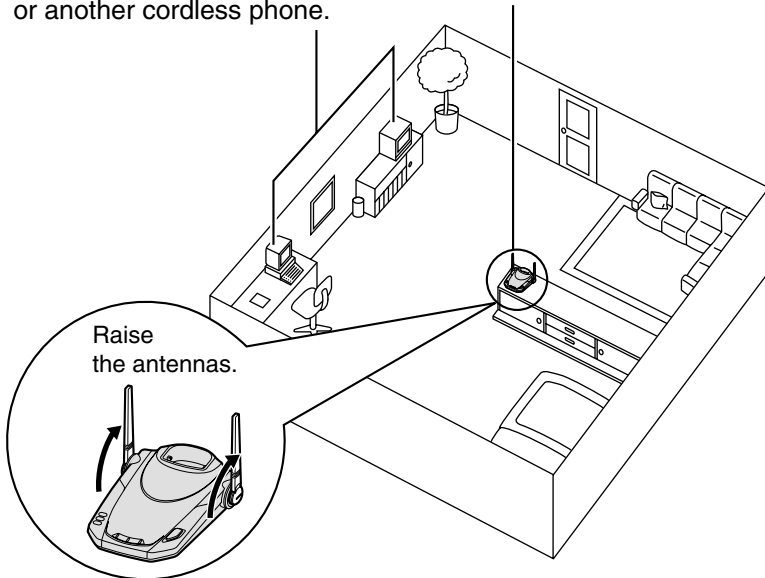

Note:

While using the handset:

- If you are near a microwave oven which is being used, noise may be heard from the receiver. Move away from the microwave oven and closer to the base unit.
- If more than one cordless phone is being used and your handset is near another cordless phone's base unit, noise may be heard. Move away from the other cordless phone's base unit and closer to your base unit.

Contents

Preparation

| | |
|-------------------------------------|----|
| Location of Controls | 6 |
| Display | 8 |
| Settings | 11 |
| Connections | 11 |
| Battery Charge | 12 |
| Selecting the Dialing Mode | 14 |
| Selecting the Line Mode | 15 |
| Programmable Functions | 16 |
| Setting the Auto Talk Feature | 17 |
| Selecting the Ringer Volume | 18 |

Basic Operation

| | |
|--|----|
| Making Calls | 19 |
| Answering Calls | 21 |
| Caller ID Service | 22 |
| Using the Caller List | 24 |
| Viewing the Caller List | 24 |
| Calling Back from the Caller List | 26 |
| Editing the Caller's Phone Number | 27 |
| Storing Caller List Information in the Directory | 28 |
| Erasing Caller List Information | 29 |

Advanced Operation

| | |
|--|----|
| One-Touch Dialer | 30 |
| Storing a Phone Number in the DIRECT Button | 30 |
| Dialing the Stored Number in the DIRECT Button | 31 |
| Using the Directory | 32 |
| Storing Names and Numbers in the Directory | 32 |
| Selecting Characters to Enter Names | 34 |
| Finding Items in the Directory | 36 |
| Dialing from the Directory | 37 |
| Editing an Item in the Directory | 38 |
| Erasing an Item from the Directory | 39 |

| | |
|---|----|
| Voice Mail Service | 40 |
| Storing a Voice Mail Access Number | 40 |
| Setting the Voice Mail Tone | 41 |
| Listening to Voice Mail Messages | 42 |
| Special Features | 43 |
| Automatic Security Code Setting | 43 |
| Handset Locator | 43 |
| For Call Waiting Service Users | 44 |
| How to Use the PAUSE Button (For Analog PBX Line/Long Distance Service Users). | 44 |
| Temporary Tone Dialing (For Rotary or Pulse Service Users) | 44 |
| FLASH Button | 45 |

Useful Information

| | |
|--|----|
| Wall Mounting | 46 |
| Using the Belt Clip | 48 |
| Using an Optional Headset | 48 |
| Battery Replacement | 49 |
| Adding Another Phone | 50 |
| Before Requesting Help | 51 |
| Important Safety Instructions | 55 |
| FCC and Other Information | 57 |

Location of Controls

Handset

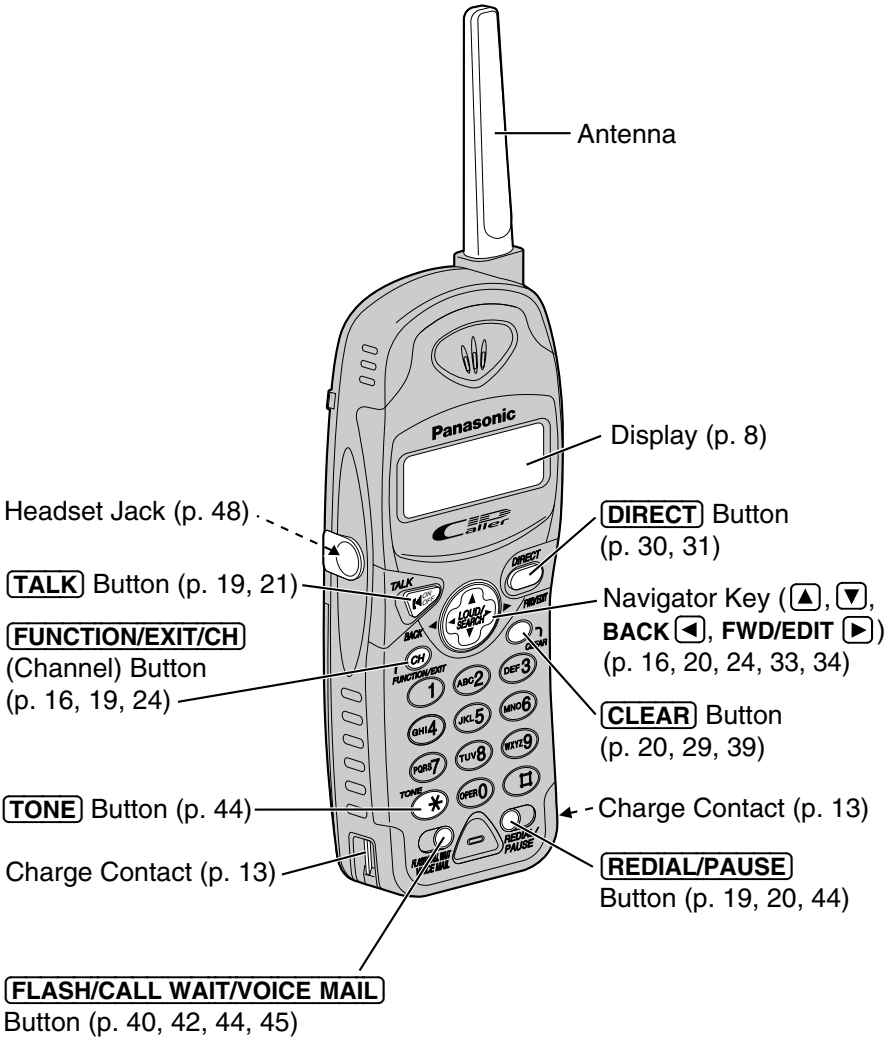

Base unit

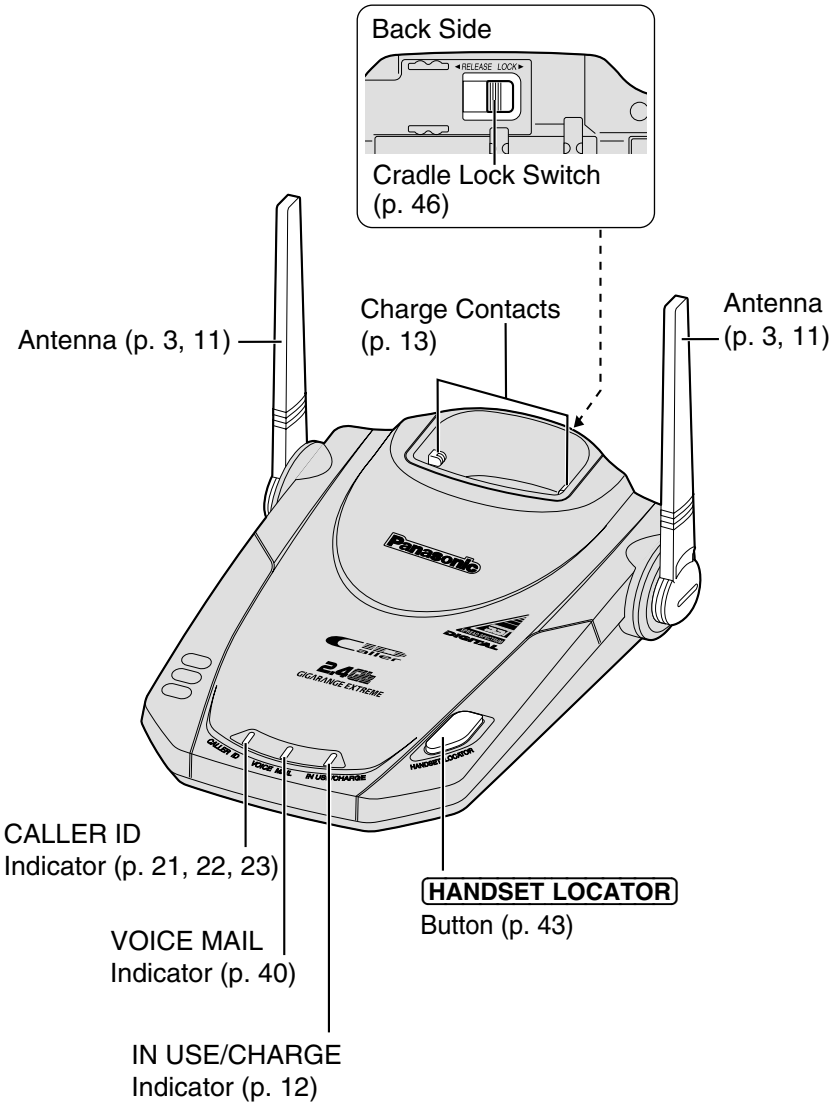

Display

The handset shows you instructions and information on the display. These display prompts are shown below.

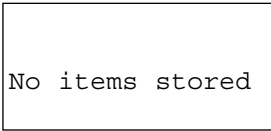

The Caller List is empty or there are no stored items in the directory.

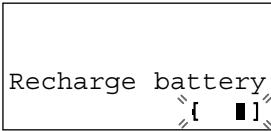



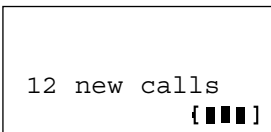

The battery needs to be charged. Place the handset on the base unit to charge the battery (p. 13).

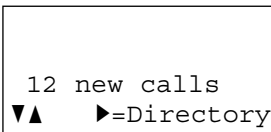

The display shows the number of new calls and the battery strength while the handset is on the base unit.



This display shows the number of new calls when  or  is pressed while the handset is off the base unit.

To search from the most recent call, press . To search from the oldest call, press  (p. 24). To go to the directory list, press **FWD/EDIT**  (Directory key).

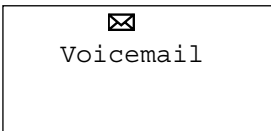

The display shows the voice mail message(s) is/are recorded (p. 40).

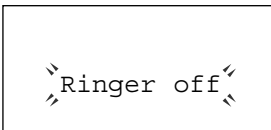

When the handset ringer volume is set to OFF (p. 18), "Ringer off" will flash for about 45 seconds before the handset returns to the standby mode (p. 13).



TINA ROBINSON
1-000-222-3333

When a call is received, the display shows the caller's name and number after the first ring.

Talk
01-06-35 {■■■■}

During a conversation, the display shows the length of the call (ex. 1 hour, 6 minutes and 35 seconds). The battery strength is also displayed (p. 12).

No link to base.
Place on cradle
and try again.

The handset has lost communication with the base unit. Place the handset on the base unit and try again.

JACK SMITH
1-222-333-4444
11:20A JAN.10 X3

This is a name from the Caller List. The display shows:
— the caller's name,
— the caller's number,
— the time and date of the last call (ex. Jan. 10, 11:20 AM), and
— the number of times called (ex. 3 times).

Ann
1234567890

This is a name from the directory. The stored name and phone number are displayed.

Paging

The base unit is paging the handset (p. 43).

NANCY BROWN
1-000-222-3333
----Waiting-----

A second call is received during a conversation (p. 44).

➔ Display

Please lift up
and try again

⏴, ⏵, **BACK** ⏪ or **FWD/EDIT** ⏩ was pressed with the handset while the handset was on the base unit. Lift the handset and press the button again.

Not available

While the base unit was not in the standby mode, ⏴ or ⏵ was pressed to search the Caller List/directory list, **FWD/EDIT** ⏩ was pressed to select an option or **CLEAR** was pressed.



Directory full

When trying to store an item or Caller List information in the directory, the directory memory is full (p. 28, 33).

Save error

While storing items in the directory, the handset has lost communication with the base unit. Move closer to the base unit and try again.



Connections

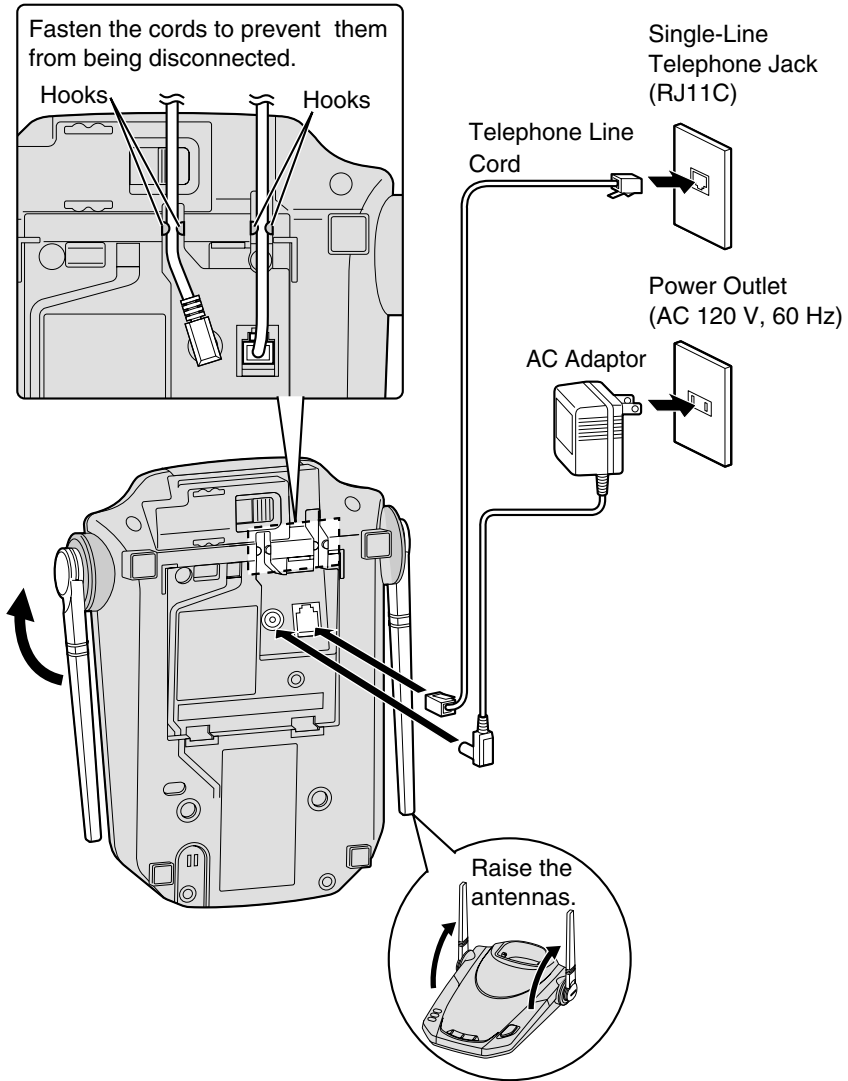

- USE ONLY WITH Panasonic AC ADAPTOR PQLV1 (Order No. PQLV1Z).
- The AC adaptor must remain connected at all times. (It is normal for the adaptor to feel warm during use.)
- To connect a standard telephone on the same line, see page 50.
- If your unit is connected to a PBX which does not support Caller ID and voice mail services, you cannot access those services.

➔ Settings

Battery Charge

Place the handset on the base unit and charge for about **6 hours** before initial use.

- The IN USE/CHARGE indicator lights and a beep sounds.

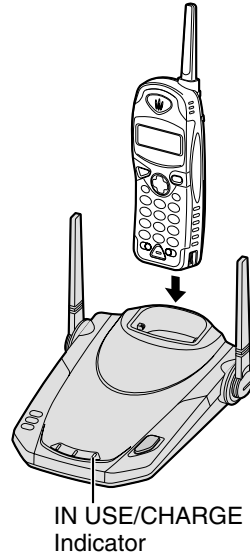

Battery strength

You can check the battery strength on the display while the handset is on the base unit, while it is in use (making/answering a call etc.), or after viewing the Caller List or directory items, programming etc.

The battery strength will remain for 5 seconds after using the handset, then the display will return to the standby mode (p. 13).

The battery strength is as shown in the chart below.

| Display prompt | Battery strength |
|------------------|------------------------|
| { ■■■ } | Fully charged |
| { ■■ } | Medium |
| { ■ } | Low |
| { ■ } (flashing) | Needs to be recharged. |



Recharge

Recharge the battery when:

- “Recharge battery” is displayed,
- “{ ■}” flashes on the display, or
- the handset beeps intermittently while it is in use.

Recharge battery
{ ■}

- If you DO NOT recharge the handset battery for more than 15 minutes, the display will keep indicating “Recharge battery” and/or “{ ■}” will continue to flash.

Battery information

After your Panasonic battery is fully charged (p. 12):

| Operation | | Approx. battery life |
|----------------------------|-------------------------|----------------------|
| While in use (TALK) | near the base unit* | Up to 4.5 hours |
| | away from the base unit | Up to 3.5 hours |
| While not in use (Standby) | | Up to 11 days |

*Within about 10 feet (3 m)

- Battery life may be shortened depending on usage conditions, such as viewing the Caller ID Caller List or directory list, and ambient temperature.
- Clean the handset and the base unit charge contacts with a soft, dry cloth once a month. Clean more often if the unit is subject to grease, dust or high humidity.** Otherwise the battery may not charge properly.
- If the battery is fully charged, you do not have to place the handset on the base unit until “Recharge battery” is displayed and/or “{ ■}” flashes. This will maximize the battery life.
- The battery cannot be overcharged.

Standby mode (The handset is off the base unit.)

The handset goes into the standby mode after you finish using the handset (making/answering a call, viewing the Caller List or directory items etc.). The display is blank, but the handset can receive calls. The battery life is conserved in this mode.

Selecting the Dialing Mode

You can program the dialing mode **using the handset near the base unit**.

If you have touch tone service, set to “Tone”. If rotary or pulse service is used, set to “Pulse”. Your phone comes from the factory set to “Tone”.

Make sure the handset is in the standby mode initially.

1 Press **FUNCTION/EXIT/CH**.

```
▶Save directory
  Ringer volume
▼▲                ▶=Yes
```

2 Press ▼ or ▲ repeatedly until the arrow points to “Program”.

```
▶Program
▼▲                ▶=Yes
```

3 Press **FWD/EDIT** ▶ (Yes key).

```
▶Save DIRECT#
  Set flash time
▼▲                ▶=Yes
```

4 Press ▼ or ▲ repeatedly until the arrow points to “Set dial mode”.

```
  Set line mode
▶Set dial mode
▼▲                ▶=Yes
```

5 Press **FWD/EDIT** ▶ (Yes key).

```
Dial mode
                :Tone
▼▲                ▶=Save
```

6 Press ▼ or ▲ to select “Pulse” or “Tone”.

```
Dial mode
                :Pulse
▼▲                ▶=Save
```

7 Press **FWD/EDIT** ▶ (Save key).

- A beep sounds.
- To return to the standby mode, press **FUNCTION/EXIT/CH**.

```
Dial mode
                :Pulse
```

- You can exit the programming mode any time by pressing **FUNCTION/EXIT/CH**.
- If the handset has lost communication with the base unit, 3 beeps sound and “No link to base. Place on cradle and try again.” is displayed.

Selecting the Line Mode

If the line is connected to a low voltage system such as a PBX, set to "B". Otherwise the Call Waiting Caller ID Feature may not be used (p. 44).

Your phone comes from the factory set to "A". **Use the handset near the base unit.**

Make sure the handset is in the standby mode initially.

- 1 Press **FUNCTION/EXIT/CH**.

▶Save directory
 Ringer volume
 ▼▲ ▶=Yes
- 2 Press ▼ or ▲ repeatedly until the arrow points to "Program".

▶Program
 ▼▲ ▶=Yes
- 3 Press **FWD/EDIT** (▶) (Yes key).

▶Save DIRECT#
 Set flash time
 ▼▲ ▶=Yes
- 4 Press ▼ or ▲ repeatedly until the arrow points to "Set line mode".

▶Set line mode
 Set dial mode
 ▼▲ ▶=Yes
- 5 Press **FWD/EDIT** (▶) (Yes key).

Line mode :A
 ▼▲ ▶=Save
- 6 Press ▼ or ▲ to select "B" or "A".

Line mode :B
 ▼▲ ▶=Save
- 7 Press **FWD/EDIT** (▶) (Save key).
 - A beep sounds.
 - To return to the standby mode, press **FUNCTION/EXIT/CH**.

Line mode :B

- You can exit the programming mode any time by pressing **FUNCTION/EXIT/CH**.
- If the handset has lost communication with the base unit, 3 beeps sound and "No link to base. Place on cradle and try again." is displayed.

Programmable Functions

You can program the following function items **using the handset near the base unit**. The display shows the programming instructions. See the corresponding pages for function details.

Make sure the handset is in the standby mode initially.

Press **FUNCTION/EXIT/CH**.



<Function menu>*

| |
|------------------|
| ▶ Save directory |
| Ringer volume |
| Program |

..... To store an item in the directory (p. 33).
..... To select the ringer volume (p. 18).

Press **FWD/EDIT**

<Function menu>*

| |
|----------------|
| ▶ Save DIRECT# |
| Set flash time |
| Save mailbox# |
| Voicemail tone |
| Set line mode |
| Set dial mode |
| Talk switching |

..... To store a phone number in the DIRECT button (p. 30).
..... To select the flash time (p. 45).
..... To store a voice mail access number (p. 40).
..... To set the voice mail tone (p. 41).
..... To select the line mode (p. 15).
..... To select the dial mode (p. 14).
..... To set the auto talk feature (p. 17).

During programming:

- *To select a desired function item, press or repeatedly until the arrow points to the item. Then press **FWD/EDIT** to go to the next step.
- You can exit the programming mode any time by pressing **FUNCTION/EXIT/CH**.
- If you do not press any buttons for 60 seconds, the unit will return to the standby mode.
- If the handset has lost communication with the base unit, 3 beeps sound and “No link to base. Place on cradle and try again.” is displayed.



Setting the Auto Talk Feature

The Auto Talk feature allows you to answer a call by lifting the handset off the base unit without pressing **TALK**. If you want to use this feature, turn the feature ON by programming. Your phone comes from the factory set to OFF.

Make sure the handset is in the standby mode initially.

1 Press **FUNCTION/EXIT/CH**.

2 Press or repeatedly until the arrow points to "Program".

```

▶Program
▼▲                               ▶=Yes
  
```

3 Press **FWD/EDIT** (Yes key).

4 Press or repeatedly until the arrow points to "Talk switching".

```

▶Talk switching
▼▲                               ▶=Yes
  
```

5 Press **FWD/EDIT** (Yes key).

```

Auto talk
                               :Off
▼▲                               ▶=Save
  
```

6 Press or to select "On" or "Off".

```

Auto talk
                               :On
▼▲                               ▶=Save
  
```

7 Press **FWD/EDIT** (Save key).

- A beep sounds.
- To return to the standby mode, press **FUNCTION/EXIT/CH**.

```

Auto talk
                               :On
  
```

- You can exit the programming mode any time by pressing **FUNCTION/EXIT/CH**.
- In order to view Caller ID information before answering a call, leave the Auto Talk feature OFF.

➡ Programmable Functions

Selecting the Ringer Volume

You can set the ringer volume to HIGH, LOW or OFF. If set to OFF, the unit will not ring. Your phone comes from the factory set to HIGH.

Make sure the handset is in the standby mode initially.

- 1 Press **FUNCTION/EXIT/CH**.
- 2 Press **▼** or **▲** repeatedly until the arrow points to "Ringer volume".

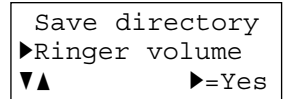

- 3 Press **FWD/EDIT** (Yes key).

- 4 Press **▼** or **▲** to select the desired volume.
 - The selected volume is displayed and rings.
 - To turn the ringer OFF**, press and hold **▼** until 2 beeps sound.
 - When set to OFF, "Ringer off" will flash for about 45 seconds before the handset returns to the standby mode.

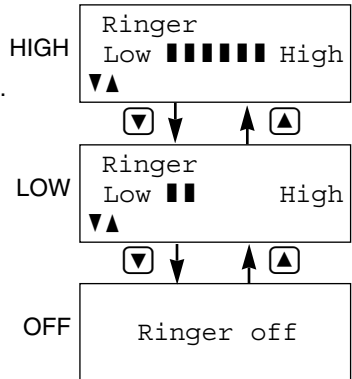

To turn the ringer ON, press **▲** or **▼** in step 4.

- The ringer will sound at the LOW level.
- You can also select the ringer volume while a call is being received. Press **▼** or **▲** while the unit is ringing.
- When you replace the battery, the selected ringer volume setting will return to the factory set (HIGH). Reprogram if necessary.

Making Calls

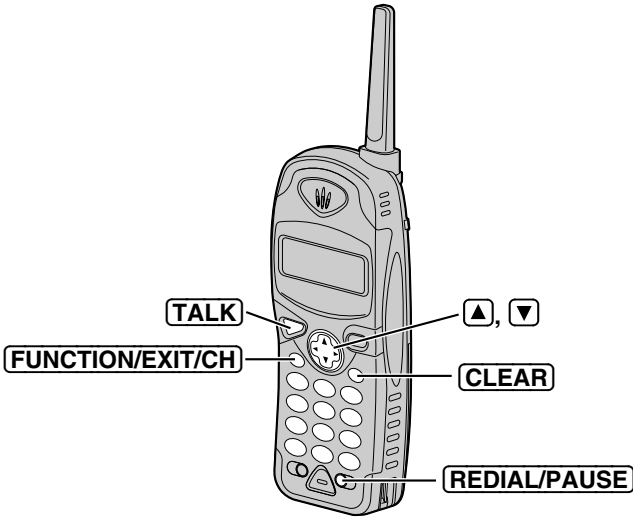

1 Press **TALK**.



2 Dial a phone number.
•The dialed number is displayed.
•After a few seconds, the display will show the length of the call and the battery strength.

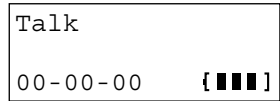

3 To hang up, press **TALK** or place the handset on the base unit.

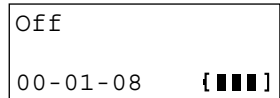

•If the handset has lost communication with the base unit, 3 beeps sound and “No link to base. Place on cradle and try again.” is displayed.

If noise interferes with the conversation

Press **FUNCTION/EXIT/CH** to select a clearer channel or move closer to the base unit.

To redial the last number dialed

Press **TALK** and press **REDIAL/PAUSE**.

➔ Making Calls

To dial after confirming the entered number

- 1 Dial a phone number.
•If you misdial, press **CLEAR** and dial again.

3334444

- 2 Press **TALK**.
•After a few seconds, the display will show the length of the call and the battery strength.

Talk

3334444

Talk

00-00-00 [||||]

- 3 To hang up, press **TALK** or place the handset on the base unit.

Off

00-01-08 [||||]

To redial after confirming the last number dialed

Press **REDIAL/PAUSE** and press **TALK**.

To adjust the receiver volume while talking

To increase, press **▲**.

To decrease press **▼**.

- Each time you press **▼** or **▲**, the volume level will change.
- The display will return to the length of the call.

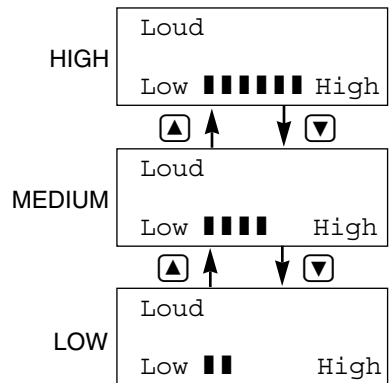

Answering Calls

When a call is received, the unit rings, “Incoming call” is displayed and the CALLER ID indicator flashes quickly.

If you subscribe to a Caller ID service, the calling party information will be displayed after the first ring (p. 22). In order to view the Caller ID information, please wait until the second ring to answer a call.

If the handset is off the base unit, press **TALK**.

- You can also answer a call by pressing any dialing button **0** to **9**, ***** or **#** (—Any Key Talk).



Auto Talk

If you set the Auto Talk feature to ON (p. 17), you can answer a call by lifting the handset off the base unit without pressing **TALK**.



Lighted handset keypad

The handset dialing buttons will light when you press a button or lift the handset off the base unit, and flash when a call is received. The lights will go out a few seconds after pressing a button, lifting the handset or answering a call.

Backlit LCD display

The lighted handset display will stay on for a few seconds after pressing a handset button or lifting the handset off the base unit.

Caller ID Service

This unit is compatible with a Caller ID service offered by your telephone company. If you subscribe to a Caller ID service, the calling party's information will be displayed after the first ring.

The unit can record information of up to 50 different callers in the Caller List. The Caller List information is sorted by the most recent to the oldest call. When the 51st call is received, the first call is deleted.

Using the list, you can automatically call back a caller. You can store the callers' names and numbers from the Caller List into the directory.

If you subscribe to both Caller ID and Call Waiting services, when a second call is received while talking, the new caller's name and phone number will be displayed (p. 44).

How caller information is displayed when a call is received

The display shows the caller's name and number after the first ring.

TINA ROBINSON
1-000-222-3333

After you answer the call, the display will show the length of the call and the battery strength.

Talk
01-06-35 [■■■■]

The CALLER ID indicator light will flash quickly when a call is being received.

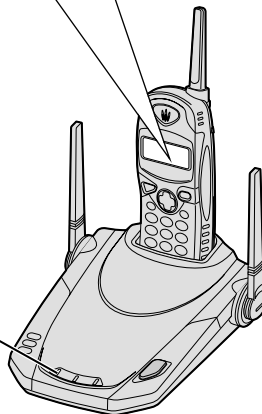

- Caller information cannot be displayed in the following cases:
 - If the caller dialed from an area which does not provide a Caller ID service, the display will show "Out of area".
 - If the caller has requested not to display his/her information, the display will show "Private caller".

- If your unit is connected to a PBX which does not support Caller ID services, you cannot access those services.
- The name display service may not be available in some areas. For further information, please contact your telephone company.

To check the number of new calls

When new calls have been received, the CALLER ID indicator flashes slowly on the base unit.

While the handset is on the base unit:

If you have received 10 new calls, the display will show the following:

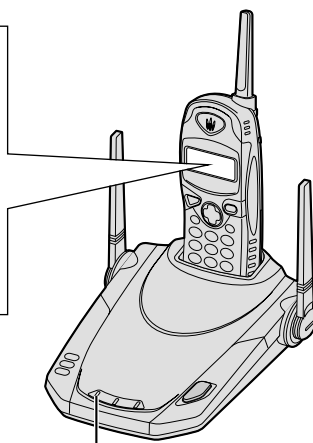
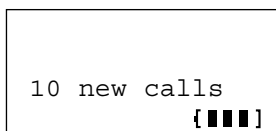

CALLER ID Indicator

While the handset is off the base unit:

Press or to turn the display on. If you have received 10 new calls, the display will show the following:

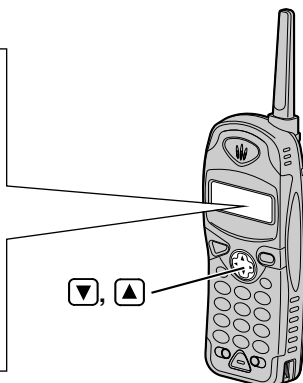
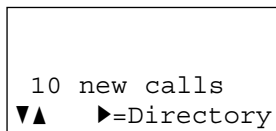

- If "No items stored" is displayed, the Caller List is empty.

Using the Caller List

Viewing the Caller List

You can view the caller list with the handset. Caller List information includes the caller's name and phone number, the time and date the call was received, and the number of times that caller called.

Make sure the handset is in the standby mode initially.

1 Press **▼** or **▲** to enter the Caller List.

- The display will show, for example, the following.

```
2 new calls
▼▲ ▶=Directory
```

- You can go to the directory list by pressing **FWD/EDIT** **▶** (p. 36).

2 To search from the most recent call, press **▼**.

To search from the oldest call, press **▲**.

- To scroll between callers, press **▼** or **▲**.

3 To exit the list, press **FUNCTION/EXIT/CH**.

- The handset will return to the standby mode.

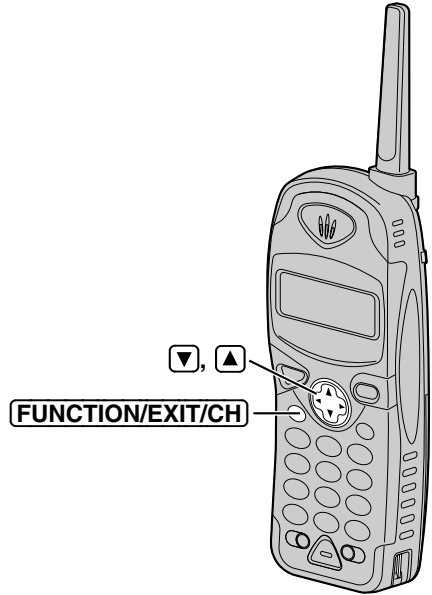

- Once new calls have been checked, “√” will be added.
- If “No items stored” is displayed, the Caller List is empty.
- If more than one call is received from the same caller, the date and time of the last call will be recorded. If the same caller calls again, the call entry with “√” will be deleted.



Ex. When you search from the most recent call:

Press or to enter the Caller List.

2 new calls
 ▶=Directory

Press .

JACK SMITH
1-222-333-4444
3:10P JUN.10

Press .

NANCY BROWN
222-3333
1:54P JUN. 9 X3

Press .

CINDY TURNER
1-234-456-7890
10:38A JUN. 9 ✓

Press .

0 new calls
 ▶=Directory

Press .

- If there is no name information for a caller, the display will only show the phone number.

To return to the previous caller,
press .

To exit the Caller List,
press **FUNCTION/EXIT/CH**.

- The handset will return to the standby mode.

Display meaning:

✓ : You have checked this caller information, answered the call or called back the caller.

X2-X9 : The number of times the same caller called (up to 9).
After checking, "X2" – "X9" will be replaced with "✓".

➔ Using the Caller List

Calling Back from the Caller List

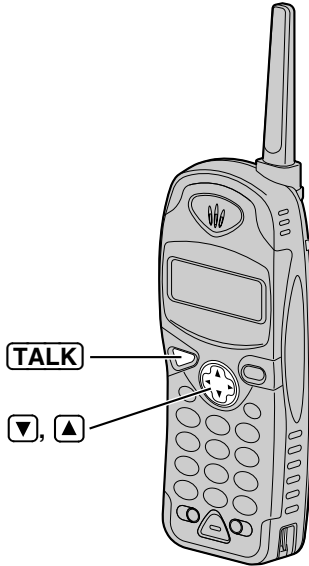

- 1 Press ▼ or ▲ to enter the Caller List.

3 new calls
▼▲ ▶=Directory

- 2 Press ▼ or ▲ repeatedly to find the desired caller.

CINDY TURNER
1-234-456-7890
11:20A JAN.12 X3

- 3 Press **TALK**.
•The displayed phone number is dialed automatically.

Talk
12344567890

Talk
01-06-35 {■■■■}

- In some cases, you may have to edit the number before dialing (p. 27). (Ex. You may have to delete “1” and the area code.)
- If a phone number is not displayed in the caller information, you cannot call back that caller.



Editing the Caller's Phone Number

You can edit a phone number into one of 4 patterns.

Make sure the handset is in the standby mode initially.

1 Press **▼** or **▲** to enter the Caller List.

```
5 new calls
▼▲ ▶=Directory
```

2 Press **▼** or **▲** repeatedly to find the desired caller, and press **FWD/EDIT** **▶**.

```
FRED PARKER
1-234-321-5555
11:20A JAN.12 ✓
```

```
▶Edit
Save directory
▼▲ ▶=Yes
```

3 While the arrow points to "Edit", press **FWD/EDIT** **▶** (Yes key).

```
FRED PARKER
1-234-321-5555
▼=Next ▶=Edit
```

4 Press **FWD/EDIT** **▶** (Edit key) to select a pattern.

•Each time you press **FWD/EDIT** **▶**, the number is rearranged into one of 4 different patterns.

(a)

(b) -

(c) 1 -

(d) 1 - -

•The order in which patterns (a)–(d) are displayed depends on how the telephone number is displayed in step 2.

(a)
▼=Next ▶=Edit

(b)
▼=Next ▶=Edit

(c)
▼=Next ▶=Edit

(d)
▼=Next ▶=Edit

5 After editing the number, you can continue with calling back or storing procedures. To call back, press **TALK** (p. 26).

To store the number in the directory, press **▼** (Next key), and press **FWD/EDIT** **▶** (Save key). (If the caller has no name information, see page 28, from step 3.)

```
FRED PARKER
321-5555
▼=Edit ▶=Save
```



•The number edited in step 4 will not be maintained in the Caller List.

➡ Using the Caller List



Storing Caller List Information in the Directory

You can store names and phone numbers that are in the Caller List into the directory.

Make sure the handset is in the standby mode initially.



1 Press  or  to enter the Caller List.

10 new calls
▼▲ ▶=Directory

2 Press  or  repeatedly to find the caller you want to store in the directory, and press **FWD/EDIT**  (Yes key).
•If the number requires editing, see page 27.



CINDY TURNER
1-234-456-7890
11:20A JAN.12 X3

▶Edit
Save directory
▼▲ ▶=Yes



3 Press  or  to select “Save directory”, and press **FWD/EDIT**  (Yes key).

Edit
▶Save directory
▼▲ ▶=Yes

If there is no name information for the caller, “Enter name” will be displayed.

a) If a name is not required, press  (Next key) and press **FWD/EDIT**  (Save key).

Enter name
◀▶ ▼=Next

b) If a name is required, enter the name (p. 34). When finished, press  (Next key) and press **FWD/EDIT**  (Save key).

Enter name
CINDY TURNER
◀▶ ▼=Next

- A beep sounds.
- To continue storing other items, repeat from step 2.
- To return to the standby mode, press **FUNCTION/EXIT/CH**.

CINDY TURNER
1234567890

- You can exit the programming mode any time by pressing **FUNCTION/EXIT/CH**.
- If the display shows “Directory full” in step 3, press **FUNCTION/EXIT/CH** to exit the list. To erase other stored items from the directory, see page 39.
- After the maximum of 50 items has been stored, “Directory full” is also displayed.
- You cannot store caller information in the directory if a phone number is not displayed.
- If 3 beeps sound and the display shows “Save error”, move closer to the base unit and start again from step 1.

Erasing Caller List Information

After checking the Caller List, you can erase some or all of the entries. **Make sure the handset is in the standby mode initially.**

To erase a specific caller from the Caller List

- 1 Press **▼** or **▲** to enter the Caller List.

10 new calls
▼▲ ▶=Directory
- 2 Press **▼** or **▲** repeatedly to find the caller you want to erase from the Caller List.

TOM REAGAN
 1-888-777-6666
 12:20A JAN.12 ✓
- 3 Press **CLEAR**.
 - A beep sounds and the information is erased.
 - To erase other items, repeat from step 2.
 - To return to the standby mode, press **FUNCTION/EXIT/CH**.

Clear

To erase all entries in the Caller List

Before erasing all entries, make sure that “0 new call” is displayed.

- 1 Press **▼** or **▲** to enter the Caller List.

0 new call
▼▲ ▶=Directory
- 2 Press **CLEAR**.

▶Exit
 All clear
▼▲ ▶=Yes
- 3 Press **▼** or **▲** to select “All clear”.

Exit
 ▶All clear
▼▲ ▶=Yes
- 4 Press **FWD/EDIT** **▶** (Yes key) or **CLEAR**.
 - A beep sounds and all entries are erased.

All clear

One-Touch Dialer

You can store a phone number in the **DIRECT** button of the handset. The stored number is dialed with a one-touch operation.

Storing a Phone Number in the DIRECT Button

Make sure the handset is in the standby mode initially.

1 Press **FUNCTION/EXIT/CH**.

2 Press **▼** or **▲** repeatedly until the arrow points to "Program".

3 Press **FWD/EDIT** **▶** (Yes key).

```
▶Save DIRECT#
  Set flash time
▼▲                               ▶=Yes
```

4 While the arrow points to "Save DIRECT#", press **FWD/EDIT** **▶** (Yes key).

```

◀▶                               ▼=Next
```

5 Enter a phone number, up to 22 digits.

- Each time you press **CLEAR** the digit to the left of the cursor is erased. To erase all digits, press and hold **CLEAR**.
- To move the cursor, press **BACK** **◀** or **FWD/EDIT** **▶**.

```
1234567890123456
789012
◀▶                               ▼=Next
```

6 Press **▼** (Next key).

- If you want to edit the entered number, press **▲** (Edit key) and return to step 5.

```
1234567890123456
789012
▲=Edit                             ▶=Save
```

7 Press **FWD/EDIT** **▶** (Save key).

- A beep sounds.
- To return to the standby mode, press **FUNCTION/EXIT/CH**.

```
1234567890123456
789012
Save DIRECT#
```

- You can exit the programming mode any time by pressing **FUNCTION/EXIT/CH**.
- If a pause is required for dialing, **REDIAL/PAUSE** can be stored in a phone number in step 5. This counts as one digit (p. 44).

Dialing the Stored Number in the DIRECT Button

- 1 Press **DIRECT**.
- The stored number is displayed.

| |
|----------------------------|
| 1234567890123456 789012 |
|----------------------------|

- 2 Press **TALK**.
- The number is dialed.

| |
|------------------------------------|
| Talk 1234567890123456 789012 |
|------------------------------------|

•You can also dial the stored number by pressing **TALK** then pressing **DIRECT**.
(If your line has rotary or pulse service, any access numbers stored after pressing **TONE** will not be dialed.)

Using the Directory

You can store up to 50 names and phone numbers in the directory. All directory items are sorted by the first word in alphabetical order. Using the directory, you can make a call by selecting a name on the handset display.

Storing Names and Numbers in the Directory

Make sure the handset is in the standby mode initially.

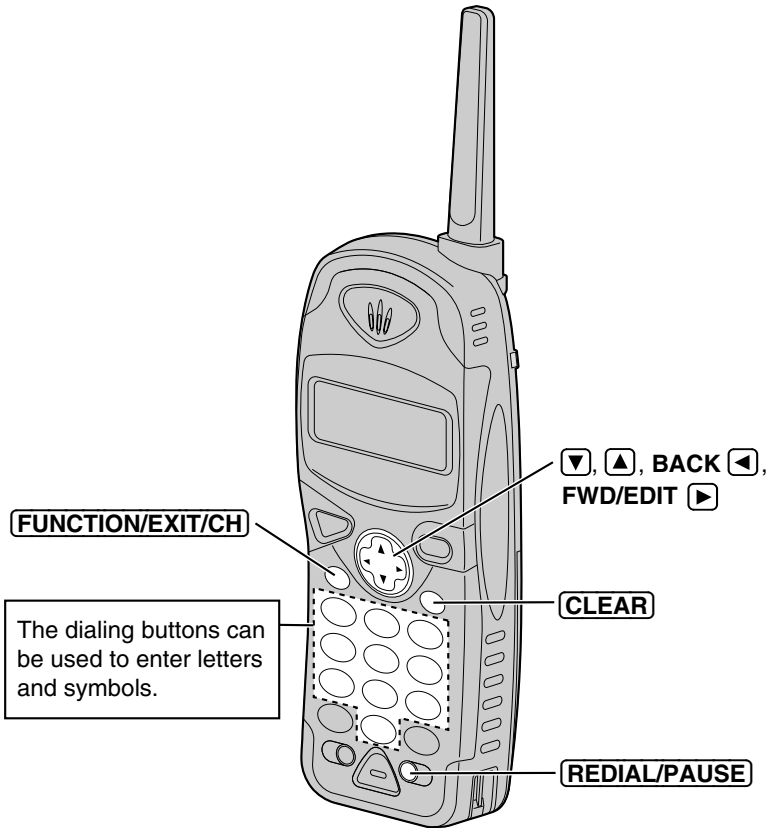



1 Press **FUNCTION/EXIT/CH**.

▶ Save directory
Ringer volume
▼▲ ▶=Yes

2 While the arrow points to “Save directory”, press **FWD/EDIT** (▶) (Yes key).
•The display shows the number of stored items in the directory.

Directory=
20 items

3 Enter a name, up to 15 characters using the dialing buttons (p. 34).

- To move the cursor, press **BACK** (◀) or **FWD/EDIT** (▶).
- If a name is not required, press (▼) (Next key) and go to step 5.

Enter name
◀▶ ▼=Next

Enter name
Tom Jones
◀▶ ▼=Next

4 Press (▼) (Next key).

Enter phone no.

5 Enter a phone number, up to 22 digits.

- If you misdial, press **CLEAR**. Digits are erased from the right. To erase all digits, press and hold **CLEAR**.

0987654321
◀▶ ▼=Next

6 Press (▼) (Next key).

- If you want to change the storing name or number, press (▲) (Edit key) repeatedly to reach the desired display and change it.

Tom Jones
0987654321
▲=Edit ▶=Save

7 Press **FWD/EDIT** (▶) (Save key).

- A beep sounds.
- To continue storing other items, repeat from step 2.
- To return to the standby mode, press **FUNCTION/EXIT/CH**.

Tom Jones
0987654321

- If a pause is required for dialing, **REDIAL/PAUSE** can be stored in a phone number in step 5. This counts as one digit (p. 44).
- You can exit the programming mode any time by pressing **FUNCTION/EXIT/CH**.
- If the display shows “Directory full” in step 2, press **FUNCTION/EXIT/CH**. To erase other stored items from the directory, see page 39.
- After the maximum of 50 items has been stored, “Directory full” is also displayed.
- If 3 beeps sound and the display shows “Save error”, move closer to the base unit and start again from step 1.

➡ Using the Directory

Selecting Characters to Enter Names

The handset dialing buttons (0 to 9), **BACK** ◀ and **FWD/EDIT** ▶ can be used to enter letters and symbols. The letters are printed on the dialing buttons. Pressing each button selects a character as shown below.



| Keys | Number of times key is pressed | | | | | | | | | | |
|----------------------|---------------------------------|-------|---|---|---|---|---|---|---|----|----|
| | 1 | 2 | 3 | 4 | 5 | 6 | 7 | 8 | 9 | 10 | 11 |
| 1 | # | & | ' | (|) | * | , | - | . | / | 1 |
| 2 | A | B | C | a | b | c | 2 | | | | |
| 3 | D | E | F | d | e | f | 3 | | | | |
| 4 | G | H | I | g | h | i | 4 | | | | |
| 5 | J | K | L | j | k | l | 5 | | | | |
| 6 | M | N | O | m | n | o | 6 | | | | |
| 7 | P | Q | R | S | p | q | r | s | 7 | | |
| 8 | T | U | V | t | u | v | 8 | | | | |
| 9 | W | X | Y | Z | w | x | y | z | 9 | | |
| 0 | 0 | Blank | | | | | | | | | |
| BACK ◀ | To move the cursor to the left | | | | | | | | | | |
| FWD/EDIT ▶ | To move the cursor to the right | | | | | | | | | | |







• To enter another character using the same dialing button, press **FWD/EDIT** ▶ to move the cursor to the next space.

If you make a mistake while entering a name

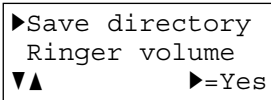
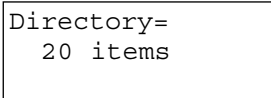
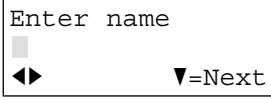
Use **BACK** ◀ or **FWD/EDIT** ▶ to move the cursor to the incorrect character, press **CLEAR** to delete and enter the correct character. Each time you press **CLEAR**, a character is erased from the right. To erase all characters, press and hold **CLEAR**.

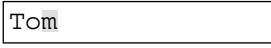

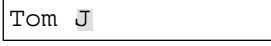
For example, to enter “Tom Jones”:

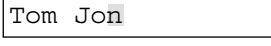
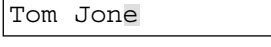
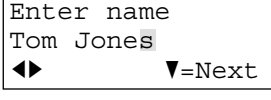
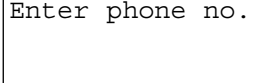
- 1 Press **FUNCTION/EXIT/CH**.

- 2 While the arrow points to “Save directory”, press **FWD/EDIT** (Yes key).

- 3 Press **8**.

- 4 Press **6** six times, then press **FWD/EDIT** (right arrow) to move the cursor to the right.

- 5 Press **6** four times.

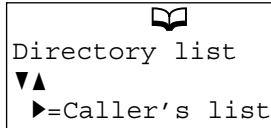
- 6 Press **FWD/EDIT** (right arrow) twice to enter a blank.

- 7 Press **5**.

- 8 Press **6** six times, then press **FWD/EDIT** (right arrow) to move the cursor to the right.

- 9 Press **6** five times.

- 10 Press **3** five times.

- 11 Press **7** eight times.

- 12 When finished, press **Next** (down arrow).
 - To enter a phone number and continue storing, see page 33, from step 5.

➡ Using the Directory

Finding Items in the Directory

Make sure the handset is in the standby mode initially.

- 1 Press **BACK** ◀ or **FWD/EDIT** ▶ to enter the directory list.



- 2 Press ▼ or ▲.
•The first item is displayed.

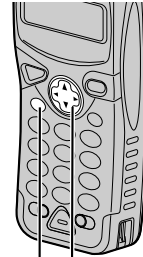

▼, ▲, BACK ◀,
FWD/EDIT ▶
FUNCTION/EXIT/CH

- 3 Press ▼ or ▲ repeatedly until the desired item is displayed.
•All directory items are stored in the order shown on the right.

To search for a name by initial

- ① Press the dialing button for the first letter of the desired name until any name with the same initial is displayed (see the Index table on page 37).
Ex. To find "Frank", press **3** repeatedly until the first item under "F" is displayed.
- ② Press ▼ repeatedly until the name is displayed.

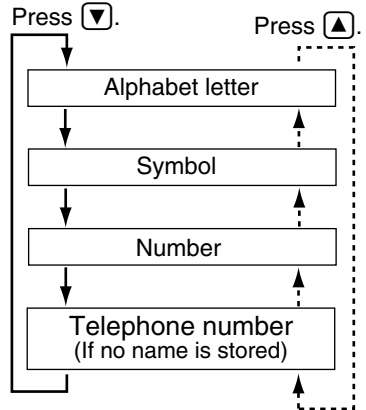

- You can leave the directory list any time by pressing **FUNCTION/EXIT/CH**.
- If "No items stored" is displayed in step 2, the directory is empty.
- In step 1, you can go to the Caller List by pressing **FWD/EDIT** ▶ (p. 24).



Index table

| Keys | Index | Keys | Index |
|------|------------------|------|---------------|
| ① | Other symbols, 1 | ⑥ | M, N, O, 6 |
| ② | A, B, C, 2 | ⑦ | P, Q, R, S, 7 |
| ③ | D, E, F, 3 | ⑧ | T, U, V, 8 |
| ④ | G, H, I, 4 | ⑨ | W, X, Y, Z, 9 |
| ⑤ | J, K, L, 5 | ⑩ | 0 |

Dialing from the Directory

Make sure the handset is in the standby mode initially.

- 1 Press **BACK** (◀) or **FWD/EDIT** (▶) to enter the directory list.

```
Directory list
▼▲
▶=Caller's list
```

- 2 Press (▼) or (▲).
•The first item is displayed.

- 3 Press (▼) or (▲) repeatedly to find the directory item that you want to dial.
•To search for the item by initial, see page 36.
•To exit the directory, press **FUNCTION/EXIT/CH**.

```
Frank
4567890
```

- 4 Press **TALK**.
•The number is dialed automatically.

```
Talk
4567890
```

- 5 To hang up, press **TALK** or place the handset on the base unit.

➡ Using the Directory

Editing an Item in the Directory

Make sure the handset is in the standby mode initially.

1 Press **BACK** (◀) or **FWD/EDIT** (▶) to enter the directory list.

```
Directory list
▼▲
▶=Caller's list
```

2 Press (▼) or (▲).
•The first item is displayed.

3 Press (▼) or (▲) repeatedly to find the directory item you want to change, and press **FWD/EDIT** (▶).

```
Jane
1234567
```

- To search for the item by initial, see page 36.
- If you do not need to change the name, go to step 5.

```
Enter name
Jane
◀▶ ▼=Next
```

4 Edit the name using the dialing buttons, **BACK** (◀) or **FWD/EDIT** (▶) (p. 34), up to 15 characters.

```
Enter name
Jane Walker
◀▶ ▼=Next
```

5 Press (▼) (Next key).
•If you do not need to change the number, go to step 7.

```
1234567
◀▶ ▼=Next
```

6 Add a number to the current number.
•Pressing **CLEAR** erases the digit to the left of the cursor. To erase all digits, press and hold **CLEAR**.

```
0981234567
◀▶ ▼=Next
```

7 Press (▼) (Next key).
•If you want to change the storing name or number, press (▲) (Edit key) repeatedly to reach the desired display and change it.

```
Jane Walker
0981234567
▲=Edit ▶=Save
```

8 Press **FWD/EDIT** (▶) (Save key).
•A beep sounds.
•To continue editing other items, repeat from step 3.
•To return to the standby mode, press **FUNCTION/EXIT/CH**.

```
Jane Walker
0981234567
```

•You can exit the programming mode any time by pressing **FUNCTION/EXIT/CH**.

Erasing an Item from the Directory

Make sure the handset is in the standby mode initially.

- 1 Press **BACK** (◀) or **FWD/EDIT** (▶) to enter the directory list.

```
Directory list
▼▲
▶=Caller's list
```

- 2 Press (▼) or (▲).
•The first item is displayed.

- 3 Press (▼) or (▲) repeatedly to find the directory item you want to erase.
•To search for the item by initial, see page 36.

```
Helen
1234567890
```

- 4 Press **CLEAR**.
•To stop erasing, press **BACK** (◀) (No key).

```
Clear?
◀=No      ▶=Yes
```

- 5 Press **FWD/EDIT** (▶) (Yes key) or **CLEAR**.
•A beep sounds and the item is erased.
•To erase other items, repeat from step 3.
•To return to the standby mode, press **FUNCTION/EXIT/CH**.

```
Clear
```

- You can exit the programming mode any time by pressing **FUNCTION/EXIT/CH**.

Voice Mail Service

Voice mail service is an electronic on-line answering system offered by your telephone company. After subscribing, the voice mail system can answer calls automatically when your line is busy or if calls are not answered. Callers can leave messages by following the pre-recorded instructions. When voice mail messages are recorded, "Voicemail" and "☒" will be displayed and the VOICE MAIL indicator on the base unit will flash.

To use this feature, you must first store your access number.

Storing a Voice Mail Access Number

Make sure the handset is in the standby mode initially.

1 Press **FUNCTION/EXIT/CH**.

2 Press **▼** or **▲** repeatedly until the arrow points to "Program", and press **FWD/EDIT** **▶** (Yes key).

| |
|----------|
| ▶Program |
| ▼▲ ▶=Yes |

3 Press **▼** or **▲** repeatedly until the arrow points to "Save mailbox#", and press **FWD/EDIT** **▶** (Yes key).

| |
|----------------------------------|
| ▶Save mailbox# Voicemail tone |
| ▼▲ ▶=Yes |

4 Enter your access number, up to 32 digits.

- You may enter pauses*.
- If you enter a wrong number, press **CLEAR**. Digits are erased from the right. To erase all digits, press and hold **CLEAR**.

| |
|---------------|
| 1234567PPP890 |
| ◀▶ ▼=Next |

5 Press **▼** (Next key).

- If you want to edit the entered number, press **▲** (Edit key) and return to step 4.

| |
|---------------|
| 1234567PPP890 |
| ▲=Edit ▶=Save |

6 Press **FWD/EDIT** **▶** (Save key).

- A beep sounds.
- To return to the standby mode, press **FUNCTION/EXIT/CH**.

| |
|---------------|
| 1234567PPP890 |
| Save mailbox# |

*For quick access to your voice mail box by using **FLASH/CALL WAIT/VOICE MAIL**, you may add pauses between your voice mail box access number and your mail box password in step 4.

EX. 1-222-333-4444 PPPP 8888

Your voice mail box access number | Pauses | Your mail box password

Pressing **REDIAL/PAUSE** once creates a 3.5 seconds delay and counts as one digit. The delay time depends on a telephone company.



To erase a stored number

Press and hold **CLEAR** in step 4 on page 40.

•You can exit the programming mode any time by pressing **FUNCTION/EXIT/CH**.

Setting the Voice Mail Tone

If your voice mail service sends a voice mail tone after a new message has been recorded, set to "On". "Voicemail" and "☒" will be displayed and the VOICE MAIL indicator on the base unit will flash when a message has been recorded in your mailbox. You will hear a series of voice mail tones followed by a dial tone after pressing **TALK**.

(Contact your service provider for details about your service.)

Set to "Off" if:

- you do not subscribe to a voice mail service,
- your voice mail service does not send a voice mail tone, or
- the unit is connected to a PBX.

Your phone comes from the factory set to "On".

Make sure the handset is in the standby mode initially.

1 Press **FUNCTION/EXIT/CH**.

2 Press **▼** or **▲** repeatedly until the arrow points to "Program".

| |
|----------|
| ▶Program |
| ▼▲ ▶=Yes |

3 Press **FWD/EDIT** **▶** (Yes key).

4 Press **▼** or **▲** repeatedly until the arrow points to "Voicemail tone".

| |
|-----------------|
| Save mailbox# |
| ▶Voicemail tone |
| ▼▲ ▶=Yes |

5 Press **FWD/EDIT** **▶** (Yes key).

| |
|----------------|
| Voicemail tone |
| :On |
| ▼▲ ▶=Save |

6 Press **▼** or **▲** to select "Off" or "On".
Press **FWD/EDIT** **▶** (Save key).

| |
|----------------|
| Voicemail tone |
| :Off |

- A beep sounds.
- To return to the standby mode, press **FUNCTION/EXIT/CH**.

•You can exit the programming mode any time by pressing **FUNCTION/EXIT/CH**.

➔ Voice Mail Service

Listening to Voice Mail Messages

After receiving a voice mail message, “Voicemail” and “☒” will be displayed and the VOICE MAIL indicator on the base unit will flash. You can listen to your voice mail message(s), follow the steps below.

- 1 Press **FLASH/CALL WAIT/VOICE MAIL**, and press **TALK**.
 - The unit is connected to the telephone line and dials the access number (p. 40).
- 2 Follow the pre-recorded instructions.
- 3 When finished, press **TALK**.

- If “Voicemail” and “☒” still remain on the display and the VOICE MAIL indicator on the base unit still flashes even if you have listened to your voice mail message(s), press **FUNCTION/EXIT/CH**, and press and hold **CLEAR** until the unit beeps. “Voicemail” and “☒” will disappear and the indicator will go off.
- If your voice mail service uses a voice mail tone and the recorded message is over 3 minutes long, “Voicemail” and “☒” may not be displayed and the VOICE MAIL indicator may not flash.
- If your voice mail service uses a voice mail tone, the tone will be heard from any parallel connected phone. If you use another phone to retrieve messages, you have to dial your access number manually.

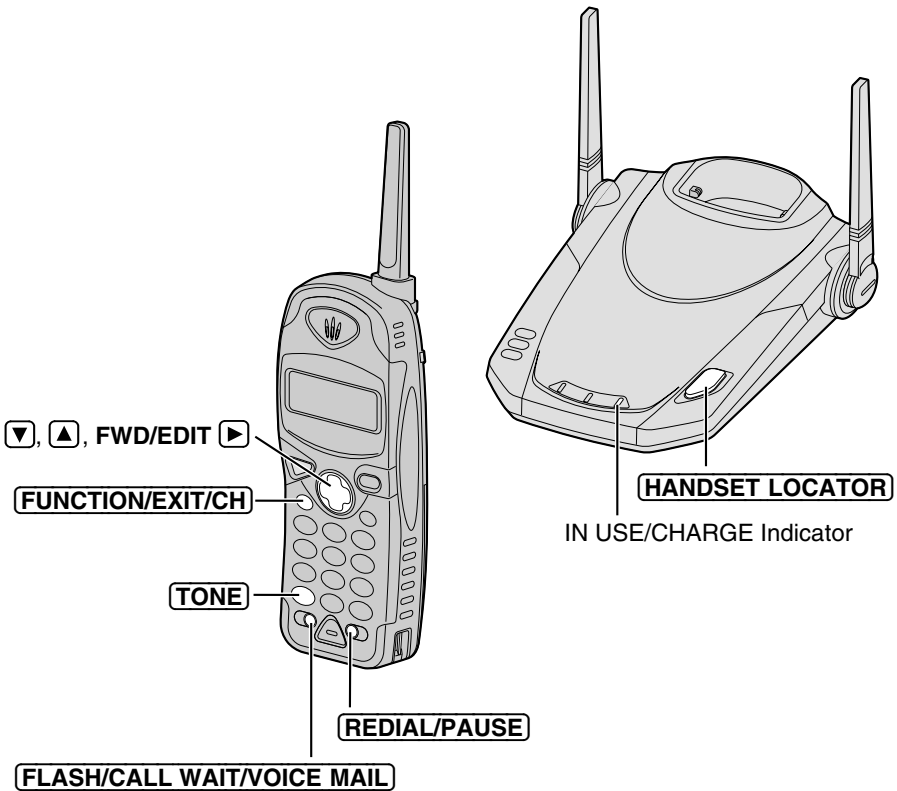

Automatic Security Code Setting

Each time you place the handset on the base unit, the unit automatically selects one of more than a million security codes. These codes help prevent the unauthorized use of your telephone line by another cordless telephone user.

Handset Locator

You can locate the handset or page the handset user with beep tones from the base unit.

- 1 Press **HANDSET LOCATOR**.
 - The IN USE/CHARGE indicator flashes. The handset beeps for 1 minute and "Paging" is displayed.
- 2 To stop paging, press **HANDSET LOCATOR** again or press **TALK** twice on the handset.

➡ Special Features

For Call Waiting Service Users

Press **FLASH/CALL WAIT/VOICE MAIL** if you hear a call-waiting tone while talking.

- The first call is put on hold and you can answer the second call.
- To return to the first caller, press **FLASH/CALL WAIT/VOICE MAIL** again.
- The call waiting service cannot be used when a parallel connected telephone is in use.
- If this function does not operate properly, consult your telephone company for details.

Call Waiting Caller ID Feature

Call Waiting Caller ID Feature allows your unit to display the second caller's information. After you hear a call-waiting tone while talking, the unit will display the caller's name with the phone number and "----Waiting-----".

| |
|---|
| NANCY BROWN 1-000-222-3333 ----Waiting----- |
|---|

- Please contact your telephone company for details and availability in your area.

How to Use the PAUSE Button (For Analog PBX Line/Long Distance Service Users)

We recommend you press **REDIAL/PAUSE** if a pause is required for dialing with a PBX or to access a long distance service.

Ex. Line access number **9** (PBX)

9 → **REDIAL/PAUSE** → Phone number

- Pressing **REDIAL/PAUSE** once creates a 3.5 second pause. This prevents misdialing when you redial or dial a stored number.
- Pressing **REDIAL/PAUSE** more than once increases the length of the pause between numbers.

Temporary Tone Dialing (For Rotary or Pulse Service Users)

Press **TONE** before entering access numbers which require tone dialing.

- The dialing mode changes to tone. You can enter numbers to access an answering service, electronic banking service, etc. When you hang up, the mode will return to pulse.
- Access numbers entered after pressing **TONE** will not be included when redialing.

FLASH Button

Pressing **FLASH/CALL WAIT/VOICE MAIL** allows you to use special features of your host PBX such as transferring an extension call or accessing special telephone services (optional) such as call waiting.

Selecting the flash time

The flash time depends on your telephone exchange or host PBX. You can select the following flash times: “700, 600, 400, 300, 250, 110, 100 or 90 ms (milliseconds)”. Your phone comes from the factory set to “700 ms”.

Make sure the handset is in the standby mode initially.

1 Press **FUNCTION/EXIT/CH**.

2 Press **▼** or **▲** repeatedly until the arrow points to “Program”.

```
▶Program
▼▲                               ▶=Yes
```

3 Press **FWD/EDIT** **▶** (Yes key).

4 Press **▼** or **▲** repeatedly until the arrow points to “Set flash time”.

```
Save DIRECT#
▶Set flash time
▼▲                               ▶=Yes
```

5 Press **FWD/EDIT** **▶** (Yes key).

```
Flash time
: 700ms
▼▲                               ▶=Save
```

6 Press **▼** or **▲** repeatedly until the desired time is displayed.

7 Press **FWD/EDIT** **▶** (Save key).

- A beep sounds.
- To return to the standby mode, press **FUNCTION/EXIT/CH**.

•You can exit the programming mode any time by pressing **FUNCTION/EXIT/CH**.

•If you are connected via a PBX, a longer flash time may be necessary to use PBX functions (transferring a call etc.). Consult your PBX supplier for the correct setting.

Wall Mounting

This unit can be mounted on a wall phone plate.

1 Adjust the angle of the cradle:

- ① Slide the lock switch to "RELEASE".
- ② Rotate the cradle 90° until it faces straight up.
- ③ Slide the lock switch to "LOCK" with the cradle facing straight up.

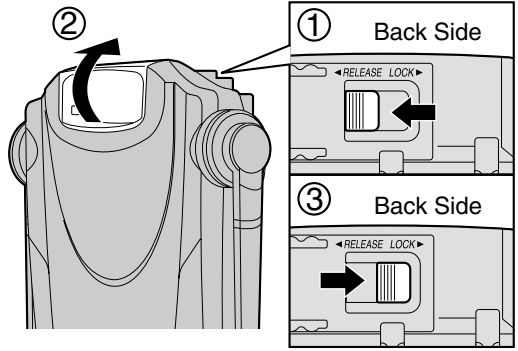

2 Connect the AC adaptor.

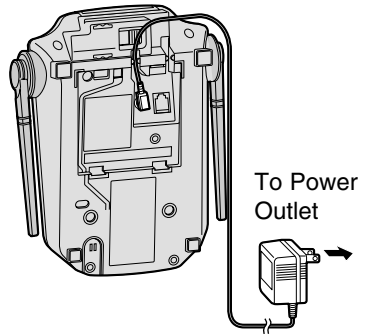

- ## 3
- ① Tuck the telephone line cord inside the wall mounting adaptor.
 - ② Connect the telephone line cord to the unit.
 - ③ Install the adaptor by pushing it in the direction of the arrow.
 - The word "UP" should face upward.

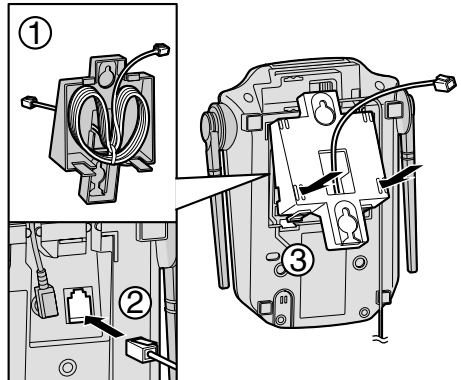

4 Connect the telephone line cord. Mount the unit, then slide down.

- Raise the antennas.

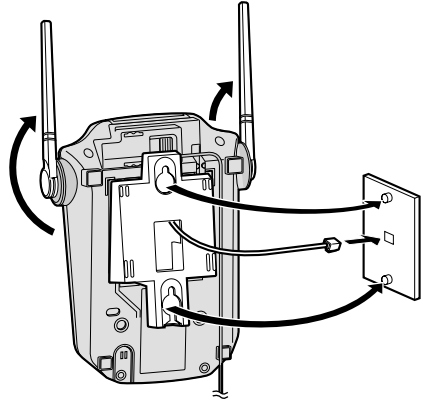

5 To charge the handset battery:
Place the handset in the cradle as shown.

- The IN USE/CHARGE indicator lights.

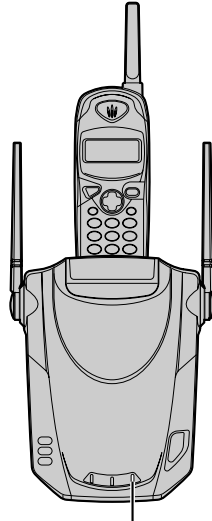

IN USE/CHARGE
Indicator

Using the Belt Clip

You can hang the handset on your belt or pocket using the belt clip.

To attach the belt clip

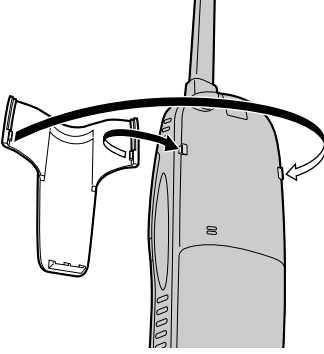

To remove the belt clip



Using an Optional Headset

Plugging an optional headset into the handset allows a hands-free phone conversation. Please use only the Panasonic KX-TCA88 headset. To order call the accessories telephone number on page 2.

Connecting an optional headset to the handset

Open the headset jack cover, and connect the headset to the headset jack as shown below.

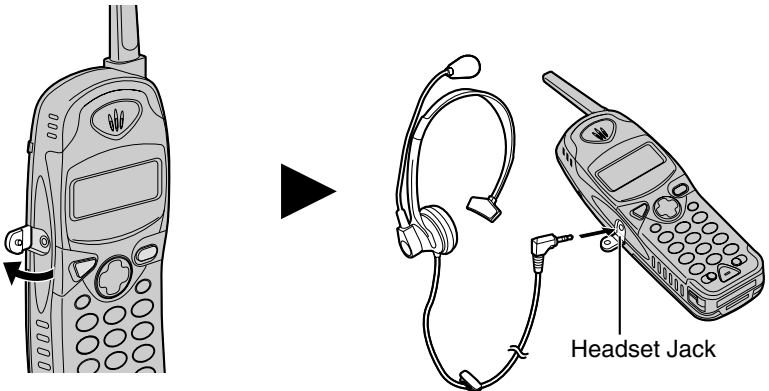

When the optional headset is connected to the handset, make sure to use the headset to talk with the caller. If you want to have a normal cordless phone conversation, disconnect the headset.

Battery Replacement

If “Recharge battery” is displayed and/or “{ ■|}” flashes after being fully charged, replace the battery with a new Panasonic P-P510 (N4HKGMB00001) battery. To order, call the accessories telephone number on page 2.

- 1 **Carefully** insert a flat metal object in the slot, and push forward to release the lock. Remove the handset cover.

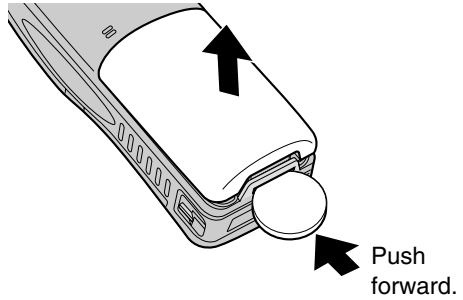

- 2 Replace the battery. Then place the battery leads inside the groove, otherwise the leads may be damaged when closing the cover.

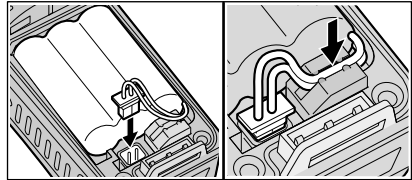

- 3 Close the cover.

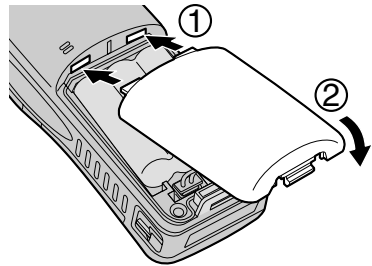

- 4 Make sure you charge the new battery for about 6 hours in order to display the battery strength prompt correctly (p. 12).

Attention:

The product you have purchased is powered by a nickel cadmium battery which is recyclable. At the end of its useful life, under various state and local laws, it is illegal to dispose of this battery into your municipal waste stream. Please call 1-800-8-BATTERY for information on how to recycle this battery.



Adding Another Phone

This unit will not function during a power failure. To connect a standard telephone on the same line, use the Panasonic T-adaptor KX-J66. To order, call the accessories telephone number on page 2.

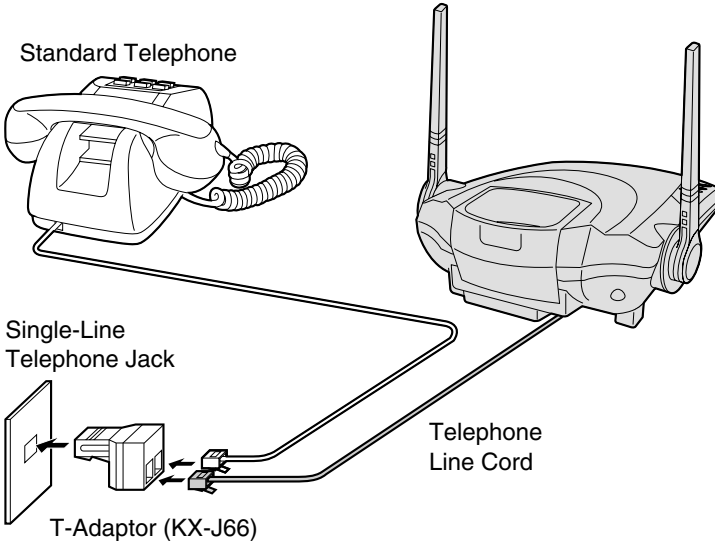

Before Requesting Help



| Problem | Remedy |
|--|---|
| “No link to base. Place on cradle and try again.” is displayed and an alarm tone sounds. | <ul style="list-style-type: none">•You are too far from the base unit. Move closer and try again.•Place the handset on the base unit and try again.•Plug in the AC adaptor.•Raise the base unit antennas. |
| The unit does not work. | <ul style="list-style-type: none">•Check the settings (p. 11–15).•Charge the battery fully (p. 12).•Clean the charge contacts and charge again (p. 13).•Install the battery properly (p. 49).•Place the handset on the base unit and unplug the AC adaptor to reset. Plug in, and try again.•Re-install the battery and place the handset on the base unit (p. 49). Try again. |
| Static, sound cuts in/out, fades. Interference from other electrical units. | <ul style="list-style-type: none">•Locate the handset and the base unit away from other electrical appliances (p. 3).•Move closer to the base unit.•Raise the base unit antennas.•Press FUNCTION/EXIT/CH to select a clearer channel. |
| The handset does not ring. | <ul style="list-style-type: none">•The ringer volume is set to OFF. Set to HIGH or LOW (p. 18). |
| The handset display is blank. | <ul style="list-style-type: none">•The handset is in the standby mode (p. 13). Press ▼, ▲, BACK ◀ or FWD/EDIT ▶ to turn the display on. |
| The handset display is still blank after pressing ▼ , ▲ , BACK ◀ or FWD/EDIT ▶ . | <ul style="list-style-type: none">•Charge the battery fully (p. 12). |

➔ Before Requesting Help

| Problem | Remedy |
|---|--|
| You cannot program items, such as the dialing mode. | <ul style="list-style-type: none">• Programming is not possible while the unit is in the talk mode or when viewing the Caller List/directory list.• Do not pause for over 60 seconds while programming.• Move closer to the base unit.• Make sure that the unit is in the standby mode. |
| Previously programmed information is erased. | <ul style="list-style-type: none">• If a power failure occurs, programmed information may be erased. Reprogram if necessary. |
| You cannot store a name and phone number in the directory. | <ul style="list-style-type: none">• You cannot store an item in the directory while the unit is in the talk mode.• Do not pause for over 60 seconds while storing. |
| While programming or searching, the unit starts to ring and stops the program/search. | <ul style="list-style-type: none">• To answer the call, press TALK. Start again from the beginning after hanging up. |
| The unit does not display the caller's name and/or phone number. | <ul style="list-style-type: none">• You need to subscribe to a Caller ID service from a telephone company.• Other telephone equipment may be interfering with your phone. Disconnect it and try again.• Other electrical appliances connected to the same outlet may be interfering with the Caller ID information.• Telephone line noise may be affecting the Caller ID information. |
| The display goes to the standby mode while viewing the Caller List. | <ul style="list-style-type: none">• Do not pause for over 60 seconds while searching. |



| Problem | Remedy |
|--|---|
| When a second call is received during a conversation, the unit does not display the new caller's name and/or phone number. | <ul style="list-style-type: none">•The line mode selection is incorrect. See page 15. |
| HANDSET LOCATOR does not function. | <ul style="list-style-type: none">•The handset is too far from the base unit.•The handset is engaged in an outside call or is viewing the Caller List/directory list. Wait until the IN USE/CHARGE indicator light goes out. |
| You cannot redial by pressing REDIAL/PAUSE . | <ul style="list-style-type: none">•If the last number dialed was more than 32 digits long, the number will not be redialed correctly.•Access numbers entered after pressing -tone will not be included when redialing.•The button has a double function as either redial or pause. It will redial the last number dialed if pressed at the outset of a call (p. 19). If another number has been dialed first, it will operate as a pause button (p. 44). |
| "Recharge battery" is displayed on the handset, "{ ■}" flashes or the unit beeps intermittently. | <ul style="list-style-type: none">•Charge the battery fully (p. 12). |
| You charged the battery fully, but "Recharge battery" is still displayed and/or "{ ■}" continues to flash. | <ul style="list-style-type: none">•Clean the charge contacts and charge again (p. 13).•Install a new battery (p. 49). |
| The IN USE/CHARGE indicator light does not go out while charging. | <ul style="list-style-type: none">•This is normal. |

➔ Before Requesting Help

| Problem | Remedy |
|---|---|
| You cannot have a conversation using the handset. | <ul style="list-style-type: none">•When the headset is connected (p. 48), you must use the headset to talk with the caller. To have a normal cordless phone conversation, disconnect the headset. |
| You cannot have a conversation using the headset. | <ul style="list-style-type: none">•Make sure that the headset is connected properly (p. 48). |
| If you cannot solve your problem. | <ul style="list-style-type: none">•Call our customer call center at 1-800-211-PANA(7262).•Panasonic's e-mail address for customer inquiries: consumerproducts@panasonic.com for customers in the USA or Puerto Rico ONLY |

Important Safety Instructions



When using this unit, basic safety precautions should always be followed to reduce the risk of fire, electric shock, or personal injury.

1. Read and understand all instructions.
2. Follow all warnings and instructions marked on this unit.
3. Unplug this unit from AC outlets before cleaning. Do not use liquid or aerosol cleaners. Use a damp cloth for cleaning.
4. Do not use this unit near water, for example, near a bathtub, washbowl, kitchen sink, or the like.
5. Place this unit securely on a stable surface. Serious damage and/or injury may result if the unit falls.
6. Do not cover slots and openings on the unit. They are provided for ventilation and protection against overheating. Never place the unit near radiators, or in a place where proper ventilation is not provided.
7. Use only the power source marked on the unit. If you are not sure of the type of power supplied to your home, consult your dealer or local power company.
8. Do not place objects on the power cord. Install the unit where no one can step or trip on the cord.
9. Do not overload wall outlets and extension cords. This can result in the risk of fire or electric shock.
10. Never push any objects through slots in this unit. This may result in the risk of fire or electric shock. Never spill any liquid on the unit.
11. To reduce the risk of electric shock, do not disassemble this unit. Take the unit to an authorized servicer when service is required. Opening or removing covers may expose you to dangerous voltages or other risks. Incorrect reassembly can cause electric shock when the unit is subsequently used.
12. Unplug this unit from the wall outlet and refer servicing to an authorized servicer when the following conditions occur:
 - A. When the power supply cord or plug is damaged or frayed.
 - B. If liquid has been spilled into the unit.
 - C. If the unit has been exposed to rain or water.
 - D. If the unit does not work normally by following the operating instructions. Adjust only controls covered by the operating instructions. Improper adjustment may require extensive work by an authorized servicer.
 - E. If the unit has been dropped or physically damaged.
 - F. If the unit exhibits a distinct change in performance.
13. During thunderstorms, avoid using telephones except cordless types. There may be a remote risk of an electric shock from lightning.
14. Do not use this unit to report a gas leak, when in the vicinity of the leak.

SAVE THESE INSTRUCTIONS

Important Safety Instructions

CAUTION:

To reduce the risk of fire or injury to persons, read and follow these instructions.

1. Use only the battery(ies) specified.
2. Do not dispose of the battery(ies) in a fire. They may explode. Check with local waste management codes for special disposal instructions.
3. Do not open or mutilate the battery(ies). Released electrolyte is corrosive and may cause burns or injury to the eyes or skin. The electrolyte may be toxic if swallowed.
4. Exercise care in handling batteries in order not to short the battery to conductive materials such as rings, bracelets, and keys. The battery and/or conductor may overheat and cause burns.
5. Charge the battery(ies) provided with or identified for use with this product only in accordance with the instructions and limitations specified in this manual.

WARNING:

TO PREVENT FIRE OR SHOCK HAZARD, DO NOT EXPOSE THE BASE UNIT TO RAIN OR ANY TYPE OF MOISTURE. ONLY THE HANDSET IS SHOCK AND SPLASH RESISTANT.

- The AC adaptor is used as the main disconnect device, ensure that the AC outlet is located/installed near the unit and is easily accessible.

Splash-Resistant (HANDSET ONLY)

The handset is designed to be splash resistant.

You can use the handset with wet hands.

CAUTION:

- **Do not immerse in water or leave under running water.**
- Keep the handset away from salt water.
- Avoid exposure to prolonged high humidity.
- Since water in headset jack may cause damage, close the headset jack cover when the optional headset is not in use. When the optional headset is connected, do not use the handset with wet hands.
- If the handset is wet, wipe with a soft dry cloth.
- The base unit is not designed to be splash resistant. Do not place the wet handset on the base unit.

Shock-Resistant (HANDSET ONLY)

Although the handset is designed to be shock resistant, do not throw or step on the handset.

FCC and Other Information



If requested by the telephone company, inform them as follows:

FCC Registration No. (found on the bottom of the unit)

Ringer Equivalence 0.1B

The particular telephone line to which the equipment is connected.

This unit must not be connected to a coin operated line.

If you are on a party line, check with your local telephone company.

Ringer Equivalence No. (REN):

The REN is useful in determining the quantity of devices you may connect to your telephone line and still have all of those devices ring when your telephone number is called. In most, but not all areas, the sum of the REN's of all devices connected to one line should not exceed five (5.0). To be certain of the number of devices you may connect to your line, as determined by the REN, you should contact your local telephone company to determine the maximum REN for your calling area.

In the event terminal equipment causes harm to the telephone network, the telephone company should notify the customer, if possible, that service may be stopped.

However, where prior notice is impractical, the company may temporarily cease service providing that they:

- (a) Promptly notify the customer.
- (b) Give the customer an opportunity to correct the problem with their equipment.
- (c) Inform the customer of the right to bring a complaint to the Federal Communication Commission pursuant to procedures set out in FCC Rules and Regulations Subpart E of Part 68.

The Telephone Company may make changes in its communications facilities, equipment, operations or procedures, where such action is reasonably required in the operation of its business and is not inconsistent with the rules and regulations in FCC Part 68.

If such changes can be reasonably expected to render any customer terminal equipment incompatible with telephone company communications facilities, or require modification or alteration of such terminal equipment, or otherwise materially affect its use or performance, the customer shall be given adequate notice in writing, to allow the customer an opportunity to maintain uninterrupted service.

When programming emergency numbers and/or making test calls to emergency numbers:

- 1. Remain on the line and briefly explain to the dispatcher the reason for the call before hanging up.
- 2. Perform such activities in the off-peak hours, such as early morning hours or late evenings.

This device complies with Part 15 of the FCC Rules. Operation is subject to the following two conditions: (1) This device may not cause harmful interference, and (2) this device must accept any interference received, including interference that may cause undesired operation.

Privacy of communications may not be ensured when using this phone.

CAUTION:

Any changes or modifications not expressly approved by the party responsible for compliance could void the user's authority to operate this device.

➡ FCC and Other Information

Note:

This equipment has been tested and found to comply with the limits for a Class B digital device, pursuant to Part 15 of the FCC Rules. These limits are designed to provide reasonable protection against harmful interference in a residential installation. This equipment generates, uses, and can radiate radio frequency energy and, if not installed and used in accordance with the instructions, may cause harmful interference to radio communications. However, there is no guarantee that interference will not occur in a particular installation. If this equipment does cause harmful interference to radio or television reception, which can be determined by turning the equipment off and on, the user is encouraged to try to correct the interference by one or more of the following measures:

- Reorient or relocate the receiving antenna.
- Increase the separation between the equipment and receiver.
- Connect the equipment into an outlet on a circuit different from that to which the receiver is connected.
- Consult the dealer or an experienced radio/TV technician for help.

Some cordless telephones operate at frequencies that may cause interference to nearby TVs and VCRs. To minimize or prevent such interference, the base of the cordless telephone should not be placed near or on top of a TV or VCR. If interference is experienced, move the cordless telephone further away from the TV or VCR. This will often reduce, or eliminate, interference.

Operating near 2.4GHz electrical appliances may cause interference. Move away from the electrical appliances and/or press the CH (Channel) button.

CAUTION:

To comply with FCC RF exposure requirements, the base unit should be installed with its antenna located at 20 cm or more from persons and handset should be carried with the specific belt-clip provided for the handset to ensure compliance. Other non-tested belt-clips or similar body-worn accessories may not comply, therefore, should be avoided.

- **Environment** — do not place the unit in a room where the temperature is less than 5°C (41°F) or greater than 40°C (104°F). Allow 10 cm (4") clearance around the unit for proper ventilation. Avoid excessive smoke, dust, mechanical vibration, shock, or direct sunlight.
- **Medical** — consult the manufacturer of any personal medical devices, such as pacemakers, to determine if they are adequately shielded from external RF (radio frequency) energy. (The unit operates in the frequency range of 2401MHz to 2472MHz, and the power output level can range from 0.001 watts to 0.20 watts.) Do not use the unit in health care facilities if any regulations posted in the area instruct you not to do so. Hospitals or health care facilities may be using equipment that could be sensitive to external RF (radio frequency) energy.
- **Routine care** — wipe the unit with a soft cloth. Do not use benzine, thinner, or any abrasive powder. When you leave the unit unused for a long period of time, unplug the AC adaptor from the outlet.
- **If there is any trouble** — disconnect the unit from the telephone line and connect a known working phone. If the known working phone operates properly, have your unit repaired by one of the authorized Panasonic Factory Service Centers. If the known working phone does not operate properly, consult your telephone company.

For product service

- Panasonic Servicenters are listed in the servicenter directory.
- Call 1-800-211-PANA(7262) for the location of an authorized servicenter.
- Panasonic's e-mail address for customer inquiries:
consumerproducts@panasonic.com
for customers in the USA or Puerto Rico ONLY

When you ship the product

- Carefully pack your unit, preferably in the original carton.
- Attach a letter, detailing the symptom, to the outside of the carton.

Symptom

- Send the unit to an authorized servicenter, prepaid and adequately insured.
- Do not send your unit to the Panasonic Consumer Electronics Company listed on the back cover or to executive or regional sales offices. These locations do not repair consumer products.

- This cordless telephone is designed for use in the United States of America. Sale or use of this product in other countries may violate local laws.
- Ce téléphone sans fil est conçu pour être utilisé aux États-Unis d'Amérique. La vente ou l'emploi de cet appareil dans certains autres pays peut constituer une infraction à la législation locale.
- Este teléfono sin cordón fue elaborado para uso en los Estados Unidos de América. La venta o el empleo de este producto en ciertos países puede constituir violación de la legislación local.
- このコードレス電話機は、日本国外での使用を目的として設計されており、日本国内での使用は法律違反となります。従って、当社では日本国内においては原則として修理などのサービスは致しかねます。

Panasonic Consumer Electronics Company,
Division of Matsushita Electric Corporation of America
One Panasonic Way, Secaucus, New Jersey 07094

Panasonic Sales Company,
Division of Matsushita Electric of Puerto Rico, Inc.
Ave. 65 de Infantería, Km. 9.5, San Gabriel Industrial Park
Carolina, Puerto Rico 00985