

Panasonic

900MHz Cordless Phone

Model No. KX-TC907-B

Pulse-or-tone dialing capability

Operating Instructions



PLEASE READ BEFORE USE AND SAVE.

Charge the battery for about 4 hours before initial use.

Preparation

Basic Operation

Advanced Operation

Useful Information

Before Initial Use

Please read **IMPORTANT SAFETY INSTRUCTIONS** on pages 28–29 before use. Read and understand all instructions.

Thank you for purchasing your new Panasonic cordless telephone.

Attach your purchase receipt here.

For your future reference

Serial No. _____

Date of purchase _____

(found on the bottom of the unit)

Name and address of dealer _____

Accessories

 To order accessories, call 1-800-332-5368.

- AC Adaptor (p. 8)
Order No. KX-TCA1-G

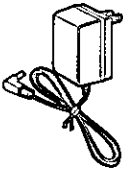

one

- Telephone Line Cord (p. 8)

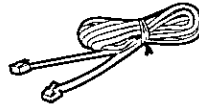

one

- Wall Mounting Adaptor (p. 25)
Order No. PQLK24Z0

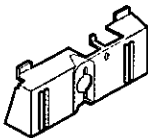

one

For Best Performance

Battery Charge

A rechargeable Ni-Cd battery powers the handset. Charge the battery for about **4 hours** before initial use (p. 9).

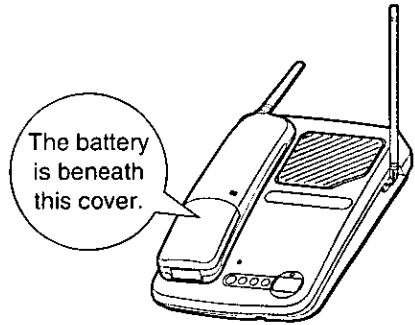

Operating Distance/Noise

Calls are transmitted between the base unit and the handset using wireless radio waves. **For maximum distance and noise free operation**, the recommended base unit location is:

Away from electrical appliances such as a TV, radio, or personal computer.

In a **HIGH and CENTRAL** location with no obstructions such as walls.

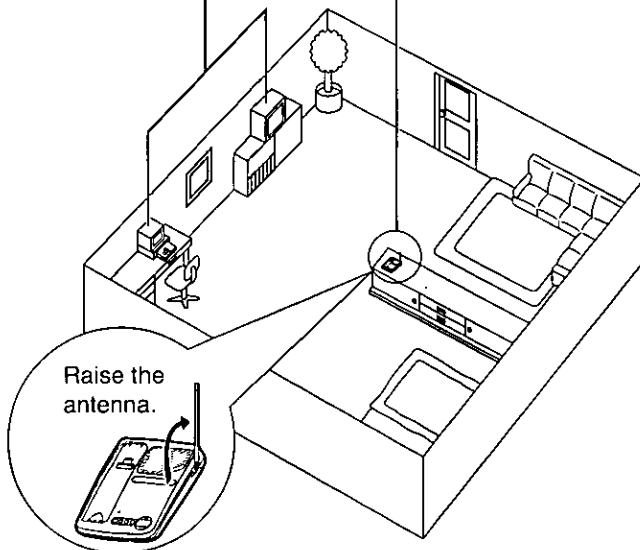

Contents

Preparation

Location of Controls	6
Settings	8
Connections	8
Battery Charge	9
Selecting the Dialing Mode	10
Selecting the Ringer Volume	11
Selecting the Handset Ringer Tone (2 Types)	11

Basic Operation

Making Calls	12
Answering Calls	14
With the Handset	14
With the Base Unit	14
Remote Speakerphone	16
Speed Dialer	18
Storing Phone Numbers in Memory	18
Dialing a Stored Number	19

Advanced Operation

Intercom	20
Transferring a Call Using the Intercom	21
Special Features	22
For Call Waiting Service Users	22
Automatic Security Code Setting	22
Temporary Tone Dialing (For Rotary or Pulse Service Users)	22
If Your Unit is Connected to a PBX (Analog PBX Line Only)	23
Adding Another Phone	23

Useful Information

Battery Replacement	24
Wall Mounting	25
Before Requesting Help	26
Important Safety Instructions	28
FCC and Other Information	30

Preparation

Basic Operation

Advanced Operation

Useful Information

Location of Controls

Handset

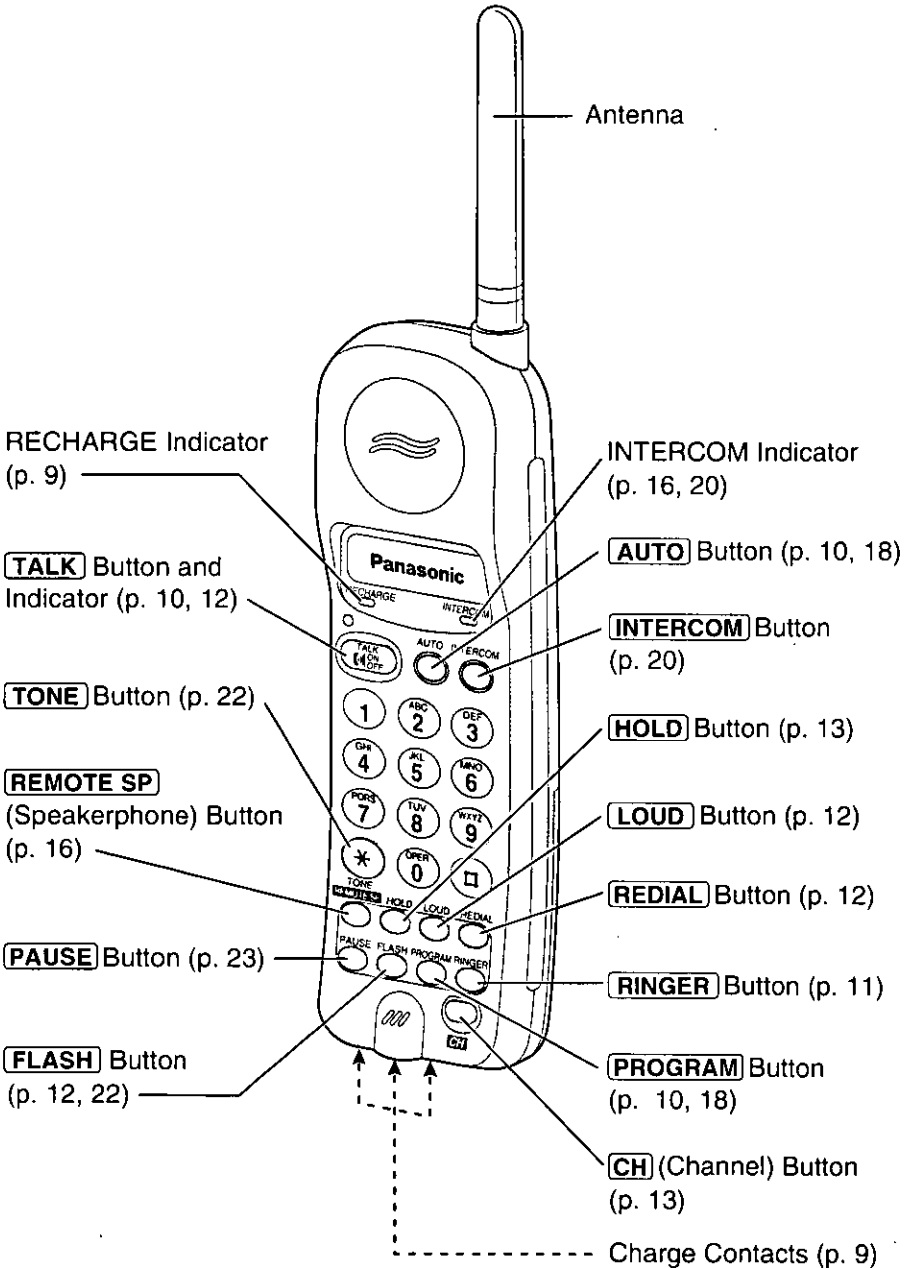

Base unit

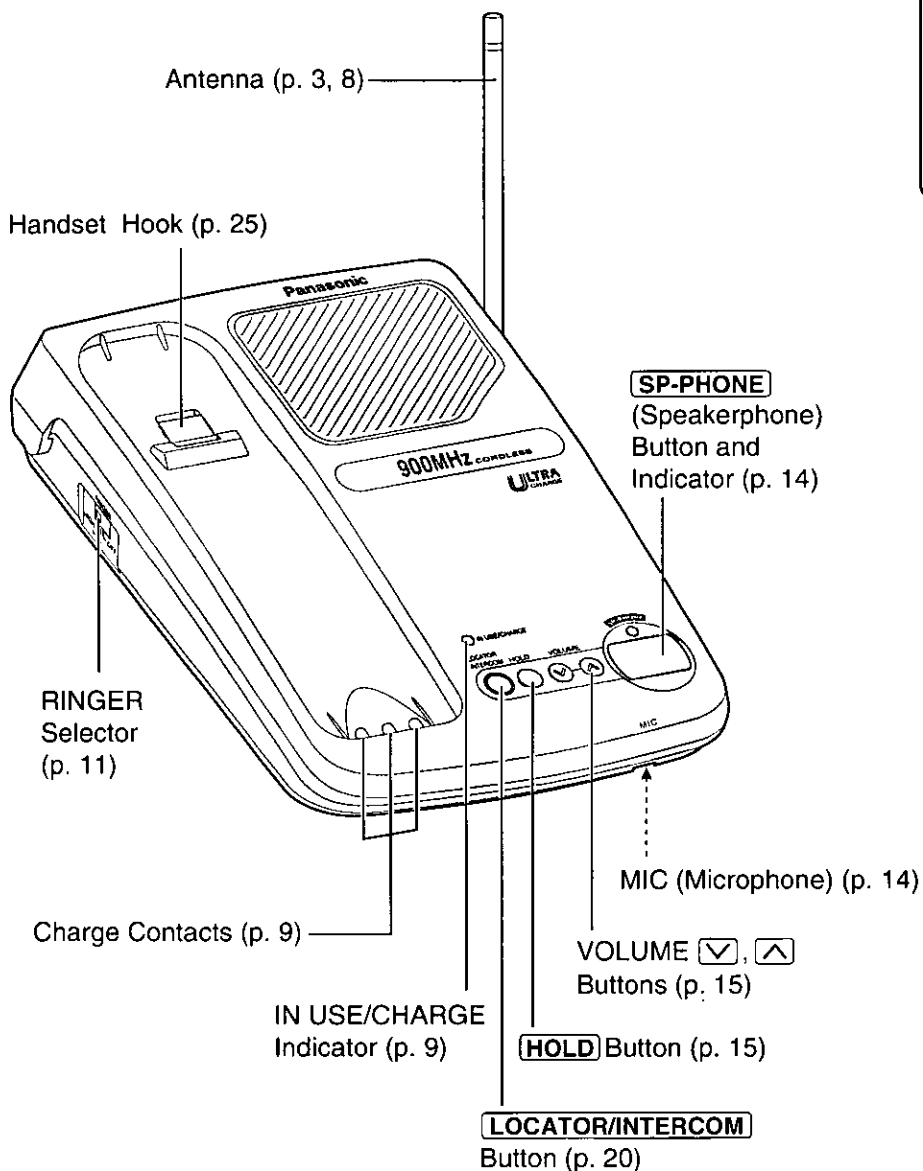

Settings

Connections

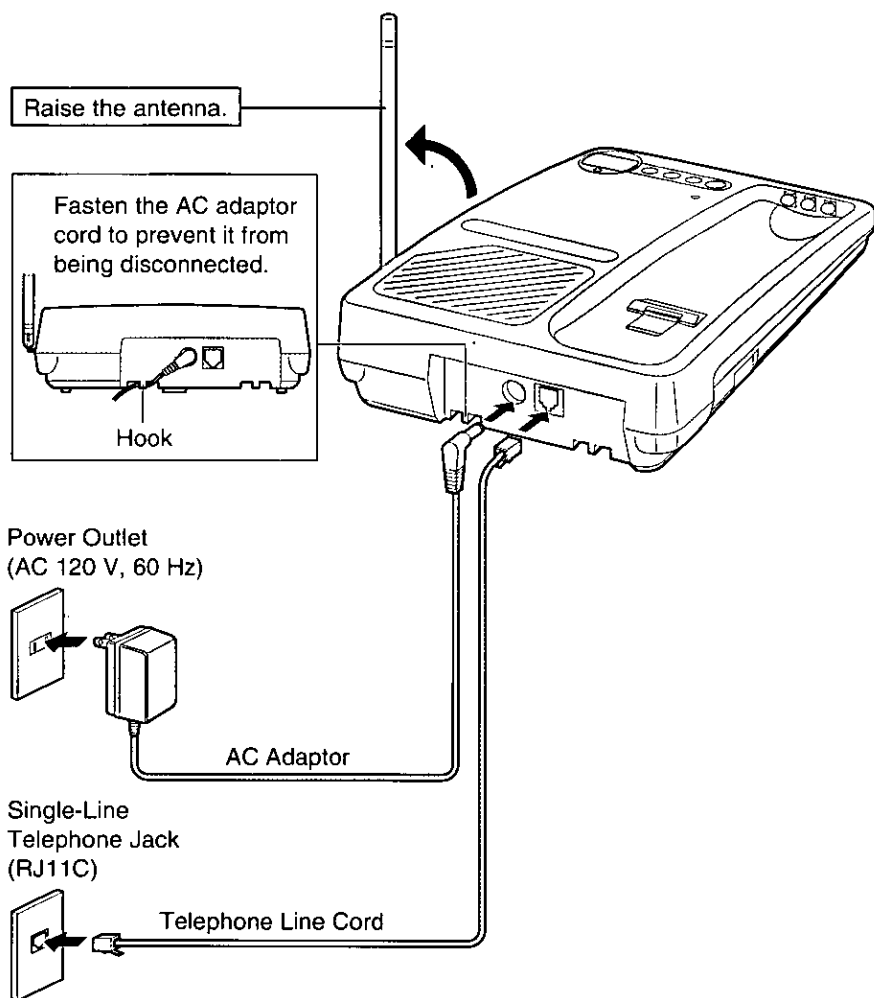

- USE ONLY WITH Panasonic AC ADAPTOR KX-TCA1 or KX-TCA1-G.
- The AC adaptor must remain connected at all times. (It is normal for the adaptor to feel warm during use.)
- To connect a standard telephone on the same line, see page 23.



Battery Charge

Place the handset on the base unit and charge for about **4 hours** before initial use.

- The IN USE/CHARGE indicator lights.

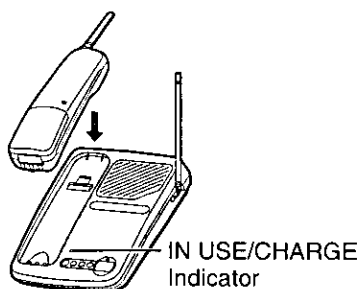

Recharge

When the RECHARGE indicator flashes or the unit beeps intermittently, recharge the battery for about 4 hours.

- If you **DO NOT** recharge the handset battery for more than 30 minutes, the RECHARGE indicator will continue to flash.

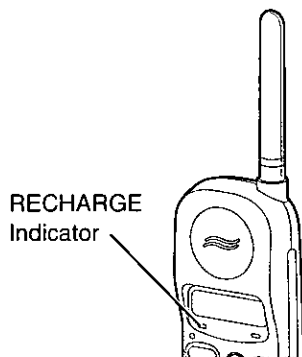

Battery information

If your Panasonic battery is fully charged:

Operation	Approx. battery life
While in use (TALK)	Up to about 6 hours
While not in use (Stand-By)	Up to about 21 days

- Battery life may vary depending on usage conditions and ambient temperature.
- **Clean the handset and the base unit charge contacts with a soft dry cloth once a month. Clean more often if the unit is subject to grease, dust or high humidity.** If not, the battery may not charge properly.
- If the battery is fully charged, you do not have to place the handset on the base unit until the RECHARGE indicator flashes. This will maximize the battery life.
- The battery cannot be overcharged.

➔ Settings

Selecting the Dialing Mode

You can program the dialing mode **by using the handset near the base unit**. If you have touch tone service, set to TONE. If rotary service is used, set to PULSE. Your phone comes from the factory set to TONE.

The TALK and SP-PHONE indicator lights must be off before programming.

- 1 Press **PROGRAM**.
 - The TALK indicator flashes.
- 2 Press **AUTO**.
- 3 To select PULSE, press **☐** twice.
OR
To select TONE, press ***** twice.
- 4 When finished, press **PROGRAM**.
 - A confirmation tone sounds.*

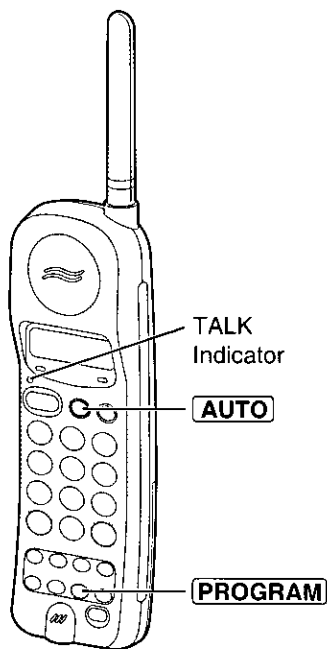

- To cancel during programming, press **PROGRAM**, then restart from step 1.
- If 3 beeps sound during programming, a wrong key was pressed. Restart from step 1.

*What the confirmation tone means

- 1 beep: The mode is different from the previously selected one.
- 2 beeps: The mode is the same as the previously selected one.

If a power failure occurs, the mode will return to the factory preset (TONE). Reprogram if necessary.

Selecting the Ringer Volume

With the handset

The TALK indicator light must be off.

- To select **HIGH (preset) or LOW**, press **RINGER** briefly.
(Each time you press the button briefly, the selected volume will ring and the ringer volume will change.)
- To turn the ringer **OFF**, press and hold **RINGER** until 2 beeps sound.
- To turn the ringer **ON**, press **RINGER** briefly. The ringer sounds at the HIGH level.

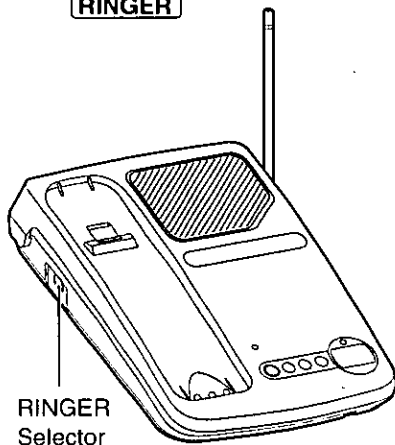
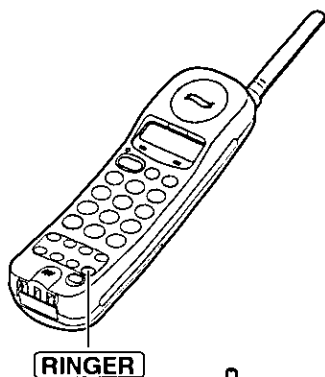

With the base unit

Set the RINGER selector to HIGH, LOW, or OFF.

- When set to OFF, the base unit will not ring.

Selecting the Handset Ringer Tone (2 Types)

The TALK indicator light must be off.

- 1 Press **RINGER**.
- 2 Press ***** within 5 seconds.
 - The selected ringer tone sounds.
 - Each time you press ***** within 5 seconds, the ringer tone will change.

Making Calls

- 1 Press **TALK**.
 - The TALK indicator lights.
- 2 Dial a telephone number.
 - If you misdial, press **FLASH** firmly then dial again.
- 3 To hang up, press **TALK** or place the handset on the base unit.
 - The TALK indicator light goes out.

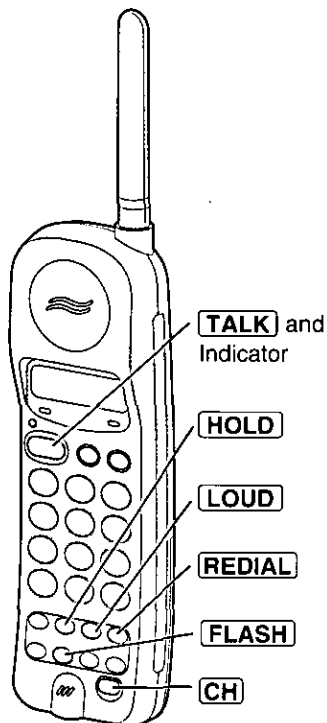

- If an alarm tone sounds in step 1, move closer to the base unit or place the handset on the base unit. Then try again.
- To switch to the speakerphone during a call with the handset, see page 16.

To redial the last number dialed

Press **TALK** ➔ **REDIAL**.

To select the receiver volume

Press **LOUD** while talking.

- Each time you press the button, the volume level will change from MEDIUM (preset) to HIGH to LOW.

If noise interferes with the conversation

Press **[CH]** to select a clearer channel or move closer to the base unit.

To put a call on hold

Press **[HOLD]**.

- The TALK indicator and the SP-PHONE indicator flash simultaneously.
- After 6 minutes, warning tones will sound every 10–15 seconds.
After a total of 10 minutes, the call will be disconnected.

To release the hold

From the handset, press **[TALK]**.

From the base unit, press **[SP-PHONE]**.

- If another phone is connected on the same line (p. 23), you can also release the hold by lifting its handset.

Answering Calls

With the Handset

If the handset is off the base unit, press **TALK**.

- You can also answer a call by pressing any dialing button

0 to **9**, ***** or **#**

(— Any Key Talk).

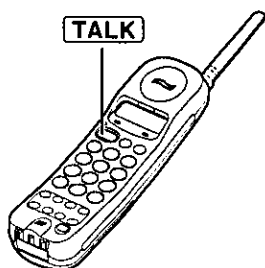

OR

If on the base unit, just lift up.

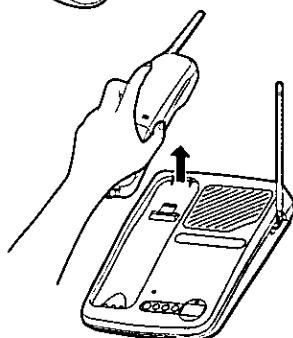

With the Base Unit

- 1 Press **SP-PHONE**.

- The SP-PHONE indicator lights.

- 2 Talk into the **MIC** (microphone).

- 3 To hang up, press **SP-PHONE**.

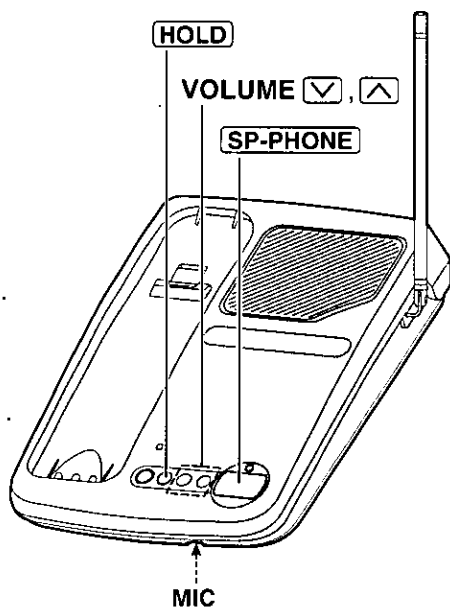

- The SP-PHONE indicator light goes out.



During the speakerphone operation:

- For best speakerphone performance, use in a quiet room and talk alternately with the caller.
- If the other party has difficulty hearing you, press **VOLUME**  to decrease the speaker volume. Decreasing the speakerphone volume will increase the microphone sensitivity.
- While using the speakerphone, if the handset is on the base unit, you may switch to it by lifting it up.

To adjust the speaker volume (12 levels) while talking

To increase, press **VOLUME** . To decrease, press **VOLUME** .

To put a call on hold

Press **HOLD**.

- The SP-PHONE indicator flashes.
- After 6 minutes, a warning tone will sound every 10–15 seconds. After a total of 10 minutes, the call will be disconnected.

To release the hold

From the base unit, press **SP-PHONE**.

From the handset, press **TALK** or lift the handset off the base unit.

- You may also press **REMOTE SP** on the handset to release the hold at the base unit.
- If another phone is connected on the same line (p. 23), you can also release the hold by lifting its handset.

Remote Speakerphone

You can switch a call with the handset to the speakerphone easily.

1 Handset:
During a call with the handset, press **REMOTE SP**.

- The call switches to the base unit.
- The INTERCOM indicator flashes.
- The SP-PHONE indicator lights.

2 Base unit:
Talk into the **MIC**.

3 Base unit:
To hang up, press **SP-PHONE**.

- The indicator lights go out.
- You can also hang up by pressing **REMOTE SP**.

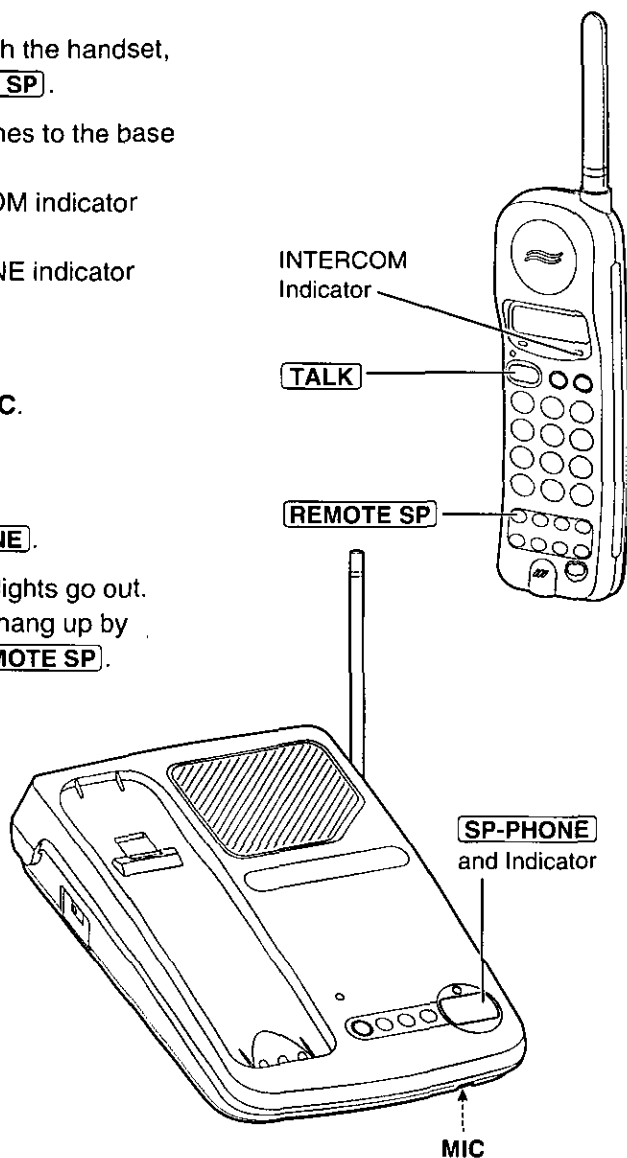

When using **REDIAL**, dialing a stored number (p. 19), etc., press **REMOTE SP** after dialing is completed.

You can turn on the base unit speakerphone using the handset.

Making calls with the remote speakerphone

1. Handset: Press **REMOTE SP**.
2. Handset: Dial a telephone number.
3. Base Unit: Talk into the **MIC**.
4. Handset: To hang up, press **REMOTE SP**.
 - You may also hang up by pressing **SP-PHONE**.

To switch to the handset (while using the remote speakerphone)

Press **TALK**.

- You can continue the conversation using the handset.
- To hang up, press **TALK** or place the handset on the base unit.

When using **REDIAL**, dialing a stored number (p. 19), etc., press **TALK** after dialing is completed.

Answering calls with the remote speakerphone

1. Handset: Press **REMOTE SP**.
2. Base Unit: Talk into the **MIC**.
3. Handset: To hang up, press **REMOTE SP**.
 - You may also hang up by pressing **SP-PHONE**.

Useful information

You can enter numbers using the handset keypad during a call with the remote speakerphone. For example, to access an answering service, electronic banking service, etc.

1. Handset: Press **REMOTE SP**.
2. Handset: Dial a telephone number.
3. Handset: Enter the required numbers while listening to the pre-recorded instructions from the base unit speakerphone.
4. Handset: To hang up, press **REMOTE SP**.
 - You may also hang up by pressing **SP-PHONE**.

Speed Dialer

Storing Phone Numbers in Memory

You can store up to 10 phone numbers in the handset. The dialing buttons (0 to 9) function as memory stations.

The TALK indicator light must be off before programming.

- 1 Press **PROGRAM**.
 - The TALK indicator flashes.
- 2 Enter a phone number up to 16 digits.
 - If you misdial, press **PROGRAM** to end storing, then restart from step 1.
- 3 Press **AUTO**.
- 4 Press a memory station number (0 to 9).
 - A confirmation tone sounds.*
 - To store other numbers, repeat steps 1 through 4.

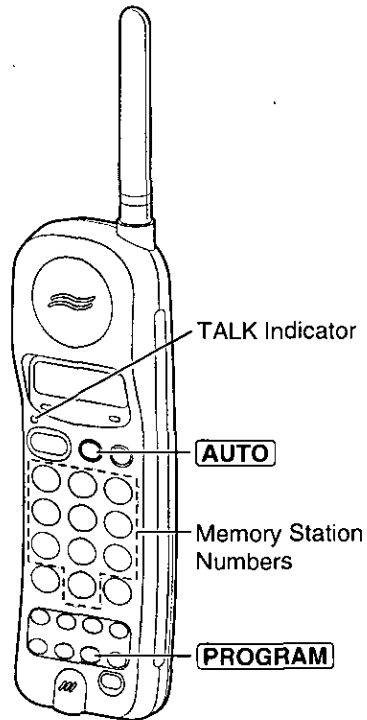

*What the confirmation tone means

1 beep: The new number is stored.

2 beeps: The number is the same as the previously stored one.

To erase a stored number

Press **PROGRAM** ➔ **AUTO** ➔ the memory station number (0 to 9) for the phone number to be erased.

Dialing a Stored Number

- 1 Press **TALK**.
- 2 Press **AUTO**.
- 3 Press the memory station number (0 to 9).
 - The stored number is dialed.

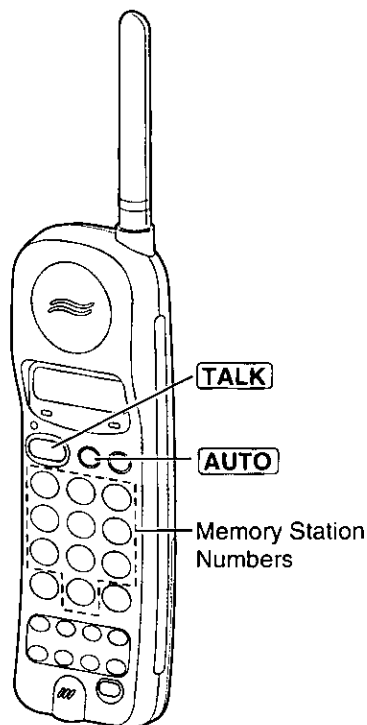

Intercom

A 2-way intercom is available between the handset and the base unit.

Paging the base unit from the handset

- 1 Handset:**
Press **INTERCOM**.
Talk to the paged party after the beeps.
 - The indicator lights.
- 2 Base unit:**
When the other party's voice is heard, answer using the **MIC**.
- 3 Handset:**
To end the intercom, press **INTERCOM**.

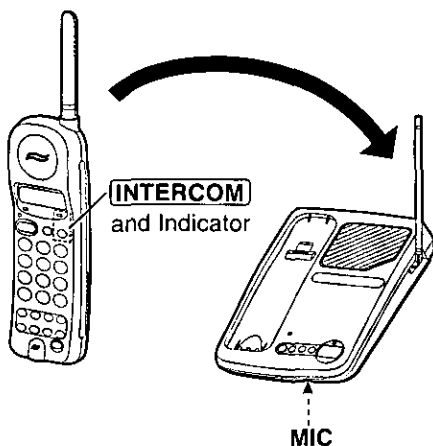

Paging the handset from the base unit (Handset locator)

Using this feature, you can locate the handset if misplaced.

- 1 Base unit:**
Press **LOCATOR/INTERCOM**.
 - The handset beeps for 1 minute.
 - To stop paging, press **LOCATOR/INTERCOM** again.
- 2 Handset:**
Press **INTERCOM** to answer.
- 3 Base unit:**
Talk into the **MIC**.
- 4 Handset:**
To end the intercom, press **INTERCOM**.

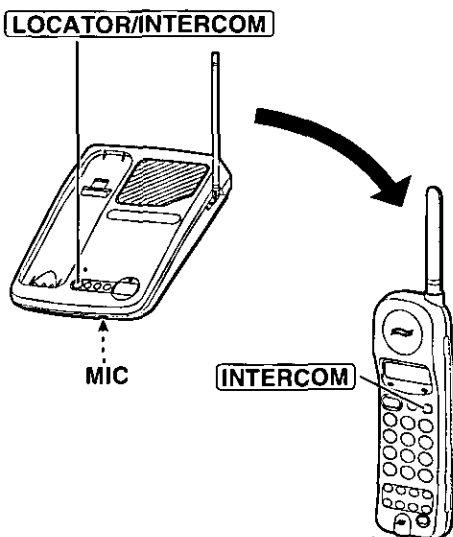

During the intercom:

- Intercom calls can only be ended by the handset.
- If the handset user has difficulty hearing the base unit user, decrease the base unit speaker volume by pressing **VOLUME** .
- If two tones sound, an incoming call has been received. To answer, press **TALK**, **REMOTE SP** or **SP-PHONE**. The intercom is ended.

Transferring a Call Using the Intercom

The intercom can be used during a call. This feature enables you to transfer the call between the handset and the base unit.

From the handset to the base unit

- 1** Handset:
During a call, press **INTERCOM**. Talk to the paged party after the beeps.
 - The call is put on hold.
 - If the base unit user does not answer, press **TALK**.
- 2** Base unit:
When the paging party's voice is heard, answer using the **MIC**.
- 3** Base unit:
To answer the call, press **SP-PHONE**.
 - The transfer is completed.
 - The handset user can join the conversation by pressing **TALK**.

From the base unit to the handset

- 1** Base unit:
During a call, press **LOCATOR/INTERCOM**.
 - The call is put on hold.
 - If the handset user does not answer, press **SP-PHONE**.
- 2** Handset:
Press **INTERCOM** to answer the page.
- 3** Handset:
To answer the call, press **TALK**.
 - The transfer is completed.
 - The base unit user can join the conversation by pressing **SP-PHONE**.

Special Features

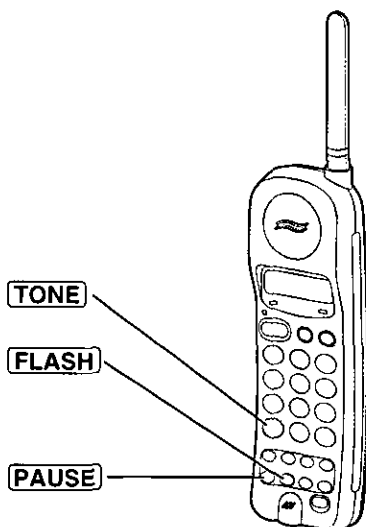

For Call Waiting Service Users

Press **FLASH** briefly if you hear a call-waiting tone while talking.

- The first call is put on hold and you can answer the second call.
- To return to the first caller, press **FLASH** again.

Automatic Security Code Setting

Whenever you place the handset on the base unit, the unit automatically selects one of a million security codes. These codes help prevent the unauthorized use of your telephone line by another cordless telephone.

Temporary Tone Dialing (For Rotary or Pulse Service Users)

Press **TONE** before entering access numbers which require tone dialing.

- The dialing mode changes to tone. You can enter numbers to access an answering service, electronic banking service, etc. When you hang up, the mode will return to pulse.

If Your Unit is Connected to a PBX (Analog PBX Line Only)

We recommend you press **PAUSE** between the access number for an outside line and the phone number.

- Pressing **PAUSE** once creates a 3.5 second pause.
This prevents misdialing when you redial or dial a stored number.
(**PAUSE** counts as one digit.)

Adding Another Phone

This unit will not function during a power failure. To connect a standard telephone on the same line, use the Panasonic T-adaptor KX-J66. To order, call 1-800-332-5368.

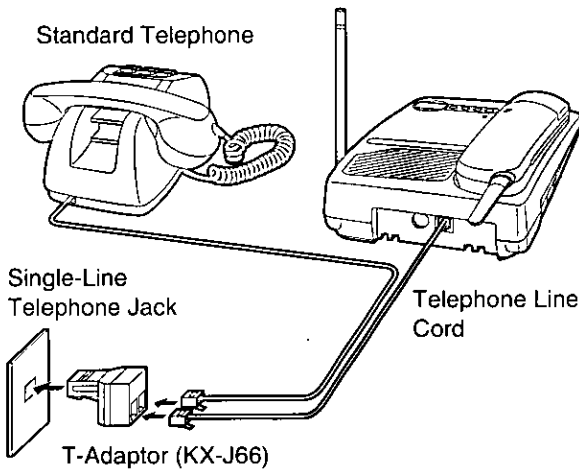

Advanced Operation

Battery Replacement

If the RECHARGE indicator flashes after being fully charged, replace the battery with a new Panasonic P-P501 (KX-A36) battery. To order, call 1-800-332-5368. To prevent memory loss, replace within 5 minutes.

- 1 Remove the cover by sliding it while pressing the arrow.

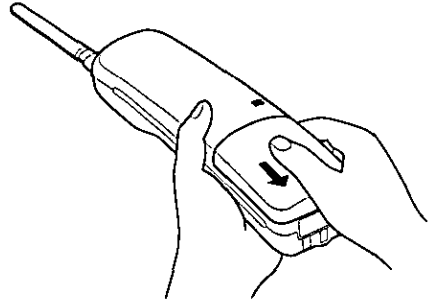

- 2 Replace the battery, then close the cover.

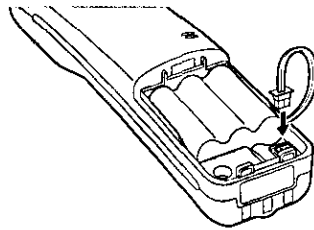

- 3 Be sure to charge the new battery for about 4 hours.

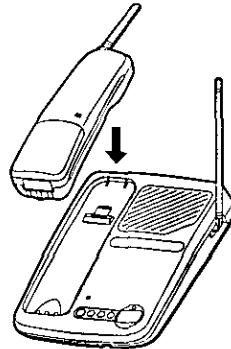

Attention:

The product you have purchased is powered by a nickel cadmium battery which is recyclable. At the end of its useful life, under various state and local laws, it is illegal to dispose of this battery into your municipal waste stream. Please call 1-800-8-BATTERY for information on how to recycle this battery.



Wall Mounting

This unit can be mounted on a wall phone plate.

- 1 Pull down the handset hook until it locks, so the tab holds the handset.

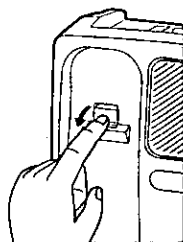

- 2 Connect the AC adaptor. Tuck the telephone line cord inside the wall mounting adaptor, then push it in the direction of the arrow.

- The word "UP" should face upward.

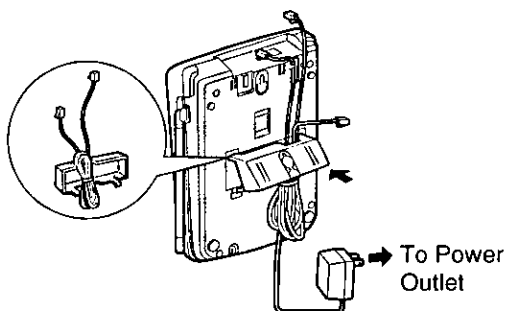

- 3 Connect the telephone line cord. Mount the unit, then slide down.

- Raise the antenna.

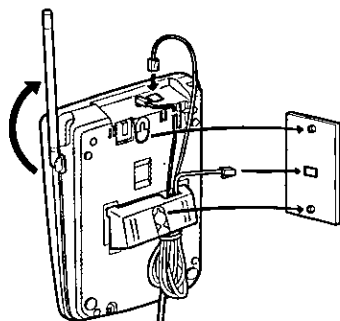

- 4 **To charge the battery:** Place the handset on the handset hook as shown.

- The IN USE/CHARGE indicator lights.

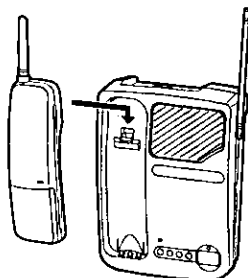

Before Requesting Help

Problem	Remedy
The unit does not work.	<ul style="list-style-type: none">• Check the settings (p. 8–11).• Charge the battery fully (p. 9).• Clean the charge contacts and charge again (p. 9).• Place the handset on the base unit and unplug the AC adaptor to reset. Plug in, then try again.• Re-insert the handset battery within 5 minutes to avoid memory loss and place the handset on the base unit. Then try again.
An alarm tone sounds when you press TALK , REMOTE SP or INTERCOM .	<ul style="list-style-type: none">• You are too far from the base unit. Move closer and try again.• Place the handset on the base unit and try again.• Plug in the AC adaptor.• Raise the base unit antenna.
Static, sound cuts in/out, fades. Interference from other electrical units.	<ul style="list-style-type: none">• Locate the handset and the base unit away from other electrical appliances (p. 3).• Move closer to the base unit.• Raise the base unit antenna.• Press CH to select a clearer channel.
The handset does not ring.	<ul style="list-style-type: none">• The ringer volume is set to OFF. Press RINGER briefly while the TALK indicator light is off (p. 11).
The base unit does not ring.	<ul style="list-style-type: none">• The RINGER selector is set to OFF. Set to HIGH or LOW (p. 11).
You cannot store a phone number in memory.	<ul style="list-style-type: none">• You cannot store a number while the unit is in the talk or intercom mode.• Do not pause for over 30 seconds while storing.

Problem	Remedy
While storing a phone number, the unit starts to ring.	<ul style="list-style-type: none"> • To answer the call, press TALK, REMOTE SP or SP-PHONE. The program will be canceled. Store the number again.
LOCATOR/INTERCOM does not function.	<ul style="list-style-type: none"> • The handset is too far from the base unit or is engaged in an outside call.
The RECHARGE indicator flashes or the unit beeps intermittently.	<ul style="list-style-type: none"> • Charge the battery fully (p. 9).
You charged the battery fully, but the RECHARGE indicator flashes.	<ul style="list-style-type: none"> • Clean the charge contacts and charge again (p. 9). • Install a new battery (p. 24).
The IN USE/CHARGE indicator light never goes out while charging.	<ul style="list-style-type: none"> • This is normal.
If you cannot solve your problem.	<ul style="list-style-type: none"> • Call our customer call center at 1-800-211-PANA(7262).

Important Safety Instructions

When using this unit, basic safety precautions should always be followed to reduce the risk of fire, electric shock, or personal injury.

1. Read and understand all instructions.
2. Follow all warnings and instructions marked on this unit.
3. Unplug this unit from AC outlets before cleaning. Do not use liquid or aerosol cleaners. Use a damp cloth for cleaning.
4. Do not use this unit near water, for example, near a bathtub, washbowl, kitchen sink, or the like.
5. Place this unit securely on a stable surface. Serious damage and/or injury may result if the unit falls.
6. Do not cover slots and openings on the unit. They are provided for ventilation and protection against overheating. Never place the unit near radiators, or in a place where proper ventilation is not provided.
7. Use only the power source marked on the unit. If you are not sure of the type of power supplied to your home, consult your dealer or local power company.
8. Do not place objects on the power cord. Install the unit where no one can step or trip on the cord.
9. Do not overload wall outlets and extension cords. This can result in the risk of fire or electric shock.
10. Never push any objects through slots in this unit. This may result in the risk of fire or electric shock. Never spill any liquid on the unit.
11. To reduce the risk of electric shock, do not disassemble this unit. Take the unit to an authorized servicenter when service is required. Opening or removing covers may expose you to dangerous voltages or other risks. Incorrect reassembly can cause electric shock when the unit is subsequently used.
12. Unplug this unit from the wall outlet and refer servicing to an authorized servicenter when the following conditions occur:
 - A. When the power supply cord or plug is damaged or frayed.
 - B. If liquid has been spilled into the unit.
 - C. If the unit has been exposed to rain or water.
 - D. If the unit does not work normally by following the operating instructions. Adjust only controls covered by the operating instructions. Improper adjustment may require extensive work by an authorized servicenter.
 - E. If the unit has been dropped or physically damaged.
 - F. If the unit exhibits a distinct change in performance.
13. During thunderstorms, avoid using telephones except cordless types. There may be a remote risk of an electric shock from lightning.
14. Do not use this unit to report a gas leak, when in the vicinity of the leak.

SAVE THESE INSTRUCTIONS

CAUTION:

To reduce the risk of fire or injury to persons, read and follow these instructions.

1. Use only the battery(ies) specified.
2. Do not dispose of the battery(ies) in a fire. They may explode. Check with local waste management codes for special disposal instructions.
3. Do not open or mutilate the battery(ies). Released electrolyte is corrosive and may cause burns or injury to the eyes or skin. The electrolyte may be toxic if swallowed.
4. Exercise care in handling batteries in order not to short the battery to conductive materials such as rings, bracelets, and keys. The battery and/or conductor may overheat and cause burns.
5. Charge the battery(ies) provided with or identified for use with this product only in accordance with the instructions and limitations specified in this manual.

WARNING:

TO PREVENT FIRE OR SHOCK HAZARD, DO NOT EXPOSE THIS PRODUCT TO RAIN OR ANY TYPE OF MOISTURE.

FCC and Other Information

If requested by the telephone company, inform them as follows:

FCC Registration No.(found on the bottom of the unit)

Ringer Equivalence0.2B

The particular telephone line to which the equipment is connected.

This unit must not be connected to a coin operated line.

If you are on a party line, check with your local telephone company.

Ringer Equivalence No. (REN):

The REN is useful in determining the quantity of devices you may connect to your telephone line and still have all of those devices ring when your telephone number is called. In most, but not all areas, the sum of the REN's of all devices connected to one line should not exceed five (5.0). To be certain of the number of devices you may connect to your line, as determined by the REN, you should contact your local telephone company to determine the maximum REN for your calling area.

In the event terminal equipment causes harm to the telephone network, the telephone company should notify the customer, if possible, that service may be stopped.

However, where prior notice is impractical, the company may temporarily cease service providing that they:

- (a) Promptly notify the customer.
- (b) Give the customer an opportunity to correct the problem with their equipment.
- (c) Inform the customer of the right to bring a complaint to the Federal Communication Commission pursuant to procedures set out in FCC Rules and Regulations Subpart E of Part 68.

The Telephone Company may make changes in its communications facilities, equipment, operations or procedures, where such action is reasonably required in the operation of its business and is not inconsistent with the rules and regulations in FCC Part 68.

If such changes can be reasonably expected to render any customer terminal equipment incompatible with telephone company communications facilities, or require modification or alteration of such terminal equipment, or otherwise materially affect its use or performance, the customer shall be given adequate notice in writing, to allow the customer an opportunity to maintain uninterrupted service.

When programming emergency numbers and/or making test calls to emergency numbers:

- 1. Remain on the line and briefly explain to the dispatcher the reason for the call before hanging up.
- 2. Perform such activities in the off-peak hours, such as early morning hours or late evenings.

This device complies with Part 15 of the FCC Rules. Operation is subject to the following two conditions: (1) This device may not cause harmful interference, and (2) this device must accept any interference received, including interference that may cause undesired operation.

CAUTION:

Any changes or modifications not expressly approved by the party responsible for compliance could void the user's authority to operate this device.

Note:

This equipment has been tested and found to comply with the limits for a Class B digital device, pursuant to Part 15 of the FCC Rules. These limits are designed to provide reasonable protection against harmful interference in a residential installation. This equipment generates, uses, and can radiate radio frequency energy and, if not installed and used in accordance with the instructions, may cause harmful interference to radio communications. However, there is no guarantee that interference will not occur in a particular installation. If this equipment does cause harmful interference to radio or television reception, which can be determined by turning the equipment off and on, the user is encouraged to try to correct the interference by one or more of the following measures:

- Reorient or relocate the receiving antenna.
- Increase the separation between the equipment and receiver.
- Connect the equipment into an outlet on a circuit different from that to which the receiver is connected.
- Consult the dealer or an experienced radio/TV technician for help.

Some cordless telephones operate at frequencies that may cause interference to nearby TVs and VCRs. To minimize or prevent such interference, the base of the cordless telephone should not be placed near or on top of a TV or VCR. If interference is experienced, move the cordless telephone further away from the TV or VCR. This will often reduce or eliminate interference.

Privacy of communications may not be ensured when using this phone.

- **Environment** — do not place the unit in room where the temperature is less than 5°C (41°F) or greater than 40°C (104°F). Allow 10 cm (4") clearance around the unit for proper ventilation. Avoid excessive smoke, dust, mechanical vibration, shock, or direct sunlight.
- **Routine care** — wipe the unit with a soft cloth. Do not use benzine, thinner, or any abrasive powder. When you leave the unit unused for a long period of time, unplug the AC adaptor from the outlet.
- **If there is any trouble** — disconnect the unit from the telephone line and connect a known working phone. If the known working phone operates properly, have your unit repaired by one of the authorized Panasonic Factory Service Centers. If the known working phone does not operate properly, consult with your telephone company.

For product service

- Panasonic Servicenters are listed in the servicenter directory.
- Call 1-800-211-PANA(7262) for the location of an authorized servicenter.

When you ship the product

- Carefully pack your unit, preferably in the original carton.
- Attach a letter, detailing the symptom, to the outside of the carton.

Symptom

- Send the unit to an authorized servicenter, prepaid and adequately insured.
- Do not send your unit to the Panasonic Consumer Electronics Company listed below or to executive or regional sales offices. These locations do not repair consumer products.

- This cordless telephone is designed for use in the United States of America. Sale or use of this product in other countries may violate local laws.
- Ce téléphone sans fil est conçu pour être utilisé aux États-Unis d'Amérique. La vente ou l'emploi de cet appareil dans certains autres pays peut constituer une infraction à la législation locale.
- Este teléfono sin cordón fue elaborado para uso en los Estados Unidos de América. La venta o el empleo de este producto en ciertos países puede constituir violación de la legislación local.
- このコードレス電話機は、日本国外での使用を目的として設計されており、日本国内での使用は法律違反となります。従って、当社では日本国内においては原則として修理などのサービスは致しかねます。

**Panasonic Consumer Electronics Company,
Division of Matsushita Electric Corporation of America**
One Panasonic Way, Secaucus, New Jersey 07094

**Panasonic Sales Company,
Division of Matsushita Electric of Puerto Rico, Inc.**
Ave. 65 de Infantería, Km. 9.5, San Gabriel Industrial Park
Carolina, Puerto Rico 00985