

# Panasonic

900MHz Cordless Phone

Model No. **KX-TC1451B**  
**KX-TC1451W**

Pulse-or-tone dialing capability

## Operating Instructions



KX-TC1451B

**PLEASE READ BEFORE USE AND SAVE.**

**Charge the battery for about 4 hours before initial use.**

**Panasonic World Wide Web address: <http://www.panasonic.com>**  
for customers in the USA or Puerto Rico

Preparation

Basic Operation

Advanced Operation

Useful Information

# Before Initial Use

Please read **IMPORTANT SAFETY INSTRUCTIONS** on page 36 before use. Read and understand all instructions.

*Thank you for purchasing your new Panasonic cordless telephone.*

Attach your purchase receipt here.

## For your future reference

Serial No. \_\_\_\_\_  
(found on the bottom of the unit)

Date of purchase \_\_\_\_\_

Name and address of dealer \_\_\_\_\_

## Accessories (included) For extra orders, call 1-800-332-5368.

- AC Adaptor (p. 8)  
Order No. PQLV1Z

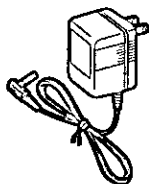

one

- Telephone Line Cord (p. 8)

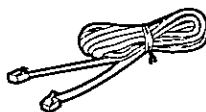

one

- Belt Clip (p. 12)  
Order No. PQKE10079Z1 (Black)  
PQKE10079Z2 (White)



one

# For Best Performance

## Battery Charge

A rechargeable Ni-Cd battery powers the handset. Charge the battery for about **4 hours** before initial use (p. 9).



## Base Unit Location

Calls are transmitted between the base unit and the handset using wireless radio waves. **For maximum distance and noise free operation**, the recommended base unit location is:

Away from electrical appliances such as a TV, radio, or personal computer.

In a **HIGH** and **CENTRAL** location with no obstructions such as walls.

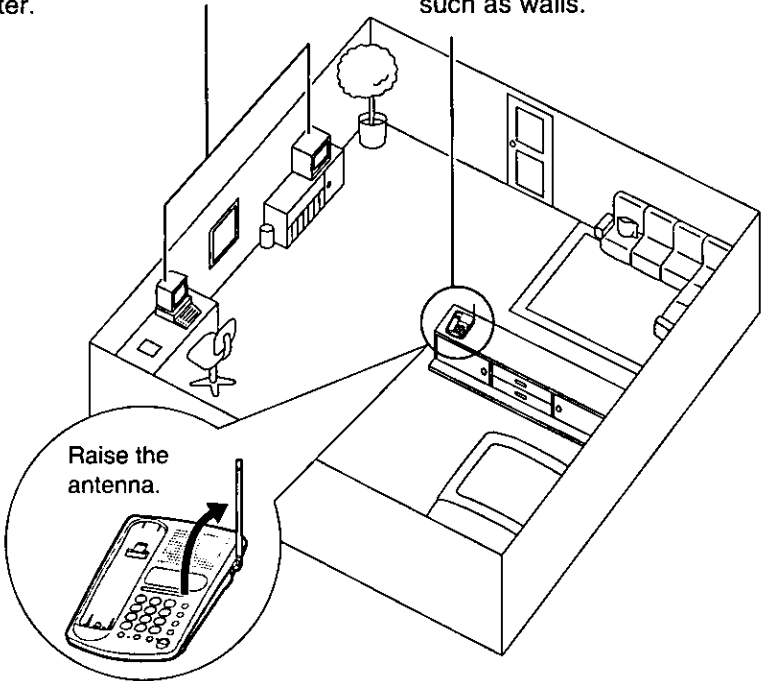

# Contents

---

## *Preparation*

<b>Location of Controls</b> .....	6
<b>Settings</b> .....	8
Connections .....	8
Battery Charge .....	9
Selecting the Dialing Mode .....	10
Selecting the Ringer Volume .....	11
Using the Belt Clip .....	12
Using the Optional Headset .....	12

## *Basic Operation*

<b>Making Calls</b> .....	14
With the Handset .....	14
With the Base Unit .....	16
Simultaneous Keypad Dialing .....	18
<b>Answering Calls</b> .....	19
With the Handset .....	19
With the Base Unit .....	19
<b>Remote Speakerphone</b> .....	20
<b>Speed Dialer (Handset)</b> .....	22
Storing Phone Numbers in Memory .....	22
Dialing a Stored Number .....	23
<b>Speed Dialer (Base Unit)</b> .....	24
Storing Phone Numbers in Memory .....	24
Dialing a Stored Number .....	25

## ***Advanced Operation***

<b>Intercom</b> .....	26
Transferring a Call Using the Intercom .....	27
<b>Special Features</b> .....	28
FLASH Button .....	28
For Call Waiting Service Users .....	29
Automatic Security Code Setting .....	29
Temporary Tone Dialing (For Rotary or Pulse Service Users) .....	29
How to Use the PAUSE Button (For Analog PBX Line/Long Distance Service Users) .....	30
<b>Adding Another Phone</b> .....	30

*Preparation*

*Basic Operation*

*Advanced Operation*

*Useful Information*

## ***Useful Information***

<b>Battery Replacement</b> .....	31
<b>Wall Mounting</b> .....	32
<b>Before Requesting Help</b> .....	33
<b>Important Safety Instructions</b> .....	36
<b>FCC and Other Information</b> .....	38

# Location of Controls

## Handset

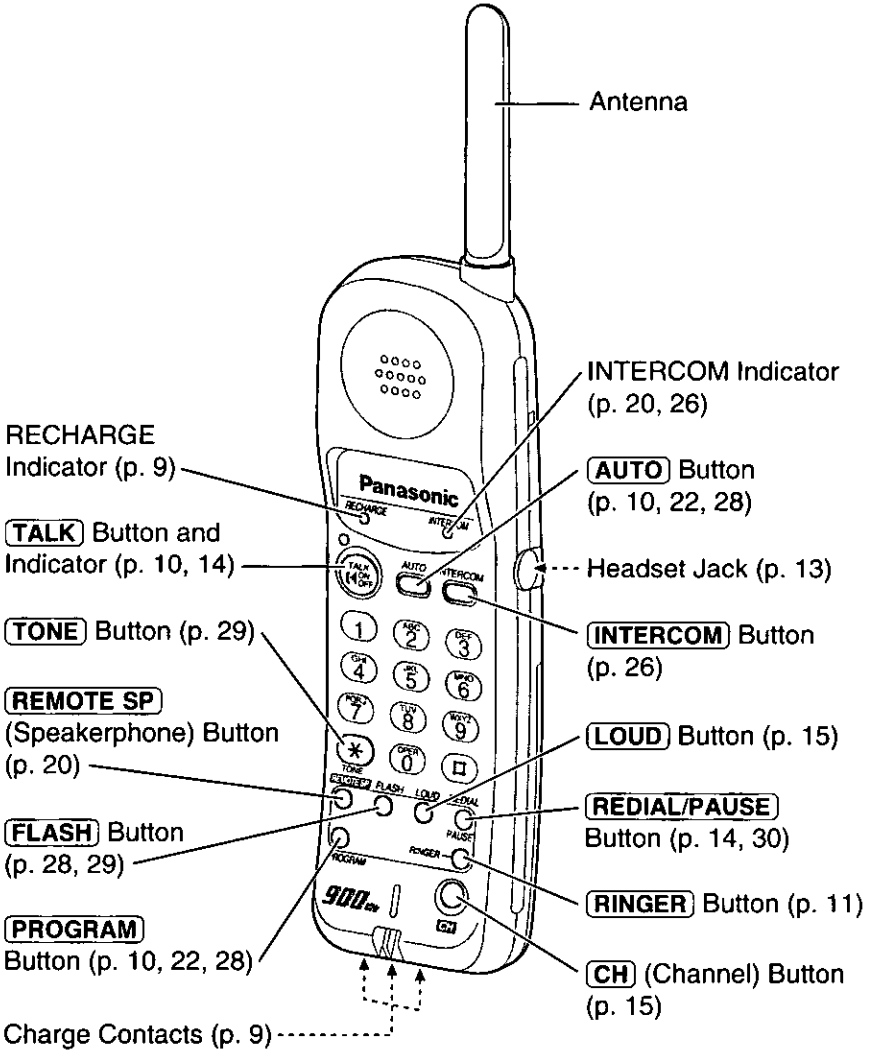

## Base unit

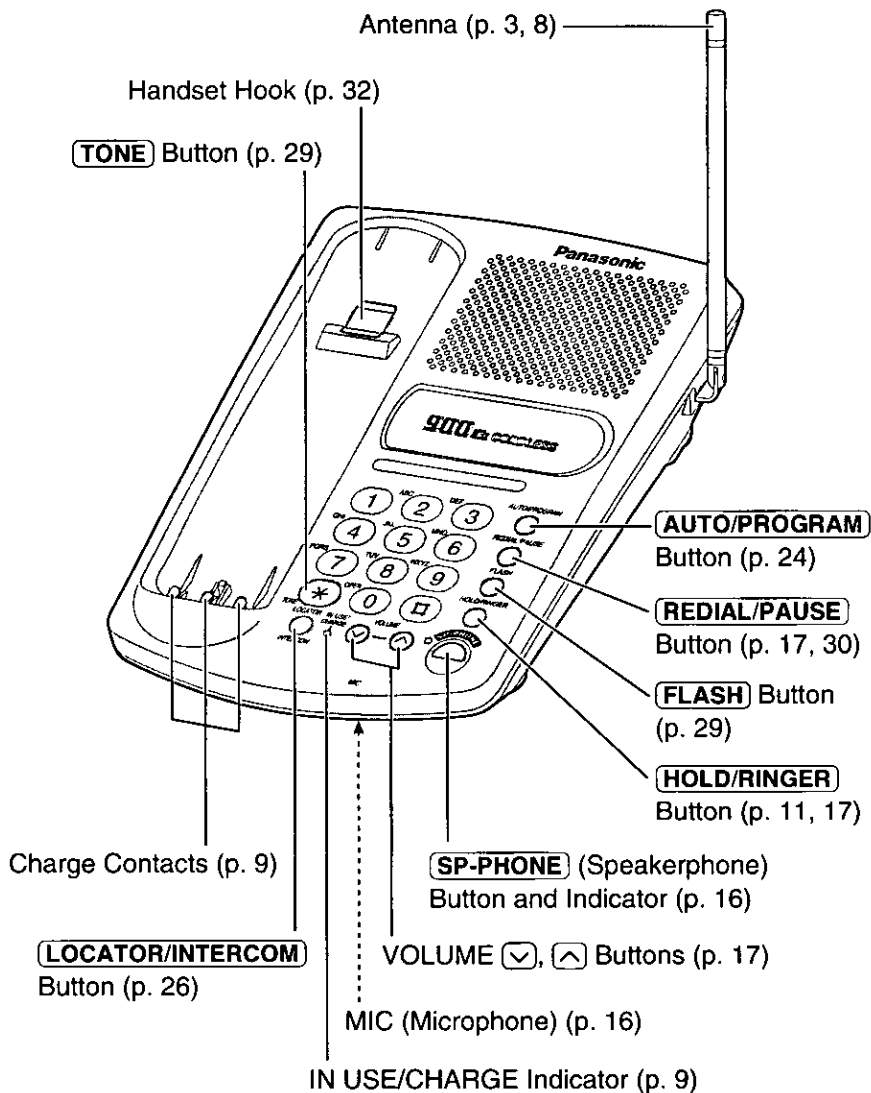

# Settings

## Connections

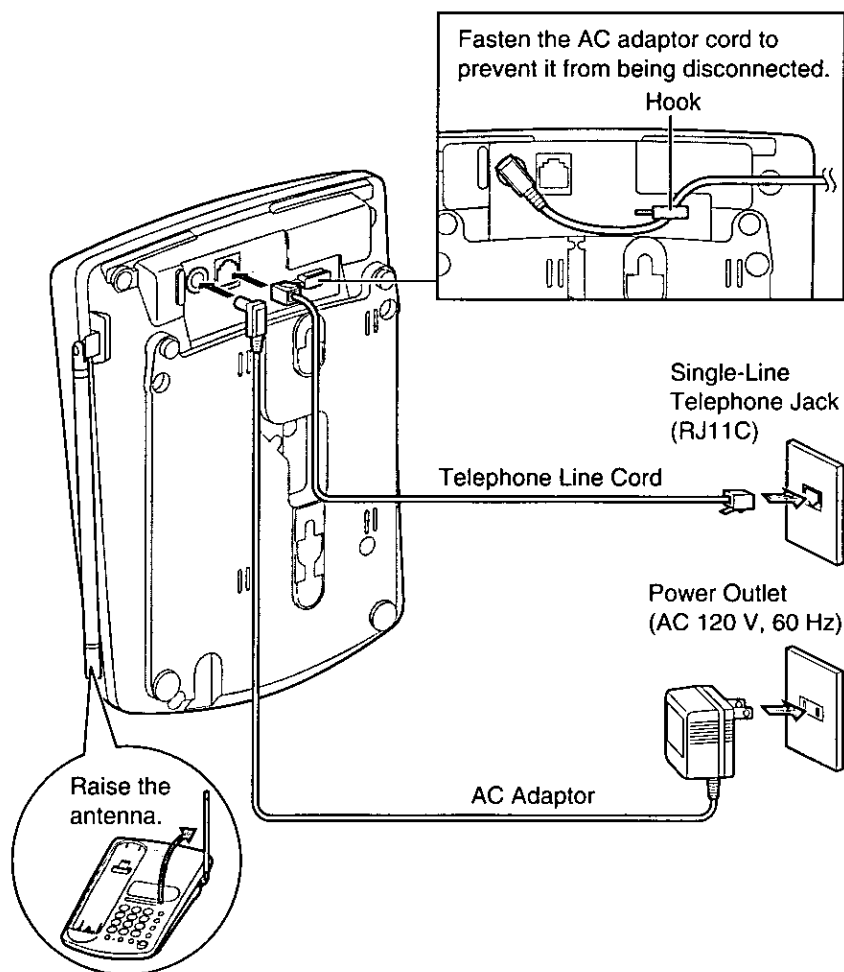

- USE ONLY WITH Panasonic AC ADAPTOR PQLV1 (Order No. PQLV1Z).
- The AC adaptor must remain connected at all times. (It is normal for the adaptor to feel warm during use.)
- To connect a standard telephone on the same line, see page 30.





## Battery Charge

Place the handset on the base unit and charge for about **4 hours** before initial use.

- The IN USE/CHARGE indicator lights.

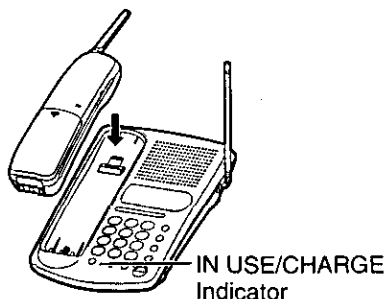

## Recharge

When the RECHARGE indicator flashes or the unit beeps intermittently, recharge the battery for about 4 hours.

- If you **DO NOT** recharge the handset battery for more than 15 minutes, the RECHARGE indicator will continue to flash.

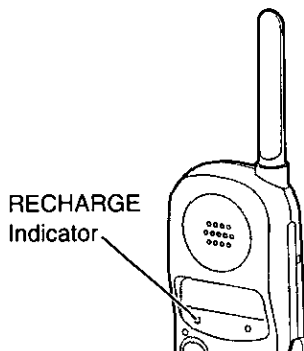

## Battery information

After your Panasonic battery is fully charged:

Operation	Approx. battery life
While in use (TALK)	Up to about 8 hours
While not in use (Stand-By)	Up to about 21 days

- Battery life may vary depending on usage conditions and ambient temperature.
- Clean the handset and the base unit charge contacts with a soft dry cloth once a month. Clean more often if the unit is subject to grease, dust or high humidity.** If not, the battery may not charge properly.
- If the battery is fully charged, you do not have to place the handset on the base unit until the RECHARGE indicator flashes. This will maximize the battery life.
- The battery cannot be overcharged.

### Selecting the Dialing Mode

You can program the dialing mode by using the handset near the base unit. If you have touch tone service, set to TONE. If rotary or pulse service is used, set to PULSE. Your phone comes from the factory set to TONE.

**The TALK and SP-PHONE indicator lights must be off before programming.**

- 1 Press **PROGRAM**.
  - The TALK indicator flashes.
- 2 Press **AUTO**.
- 3 To select PULSE, press **#** twice.  
OR  
To select TONE, press **\*** twice.
- 4 When finished, press **PROGRAM**.
  - A beep sounds.

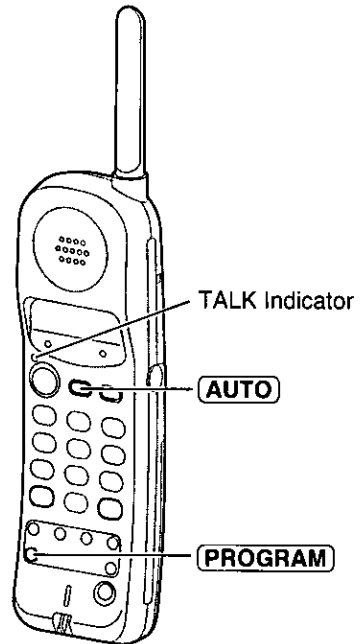

- To cancel during programming, press **PROGRAM**, then start from step 1.
- If 3 beeps sound during programming,
  - a wrong key was pressed. Restart from step 1.
  - the handset is too far from the base unit. Move closer to the base unit or place the handset on the base unit. Restart from step 1.

If a power failure occurs, the mode will return to the factory preset (TONE). Reprogram if necessary.



## Selecting the Ringer Volume

### With the handset

The TALK indicator light must be off.

- **To select HIGH (preset) or LOW,** press **RINGER**.  
(Each time you press the button, the selected volume will ring and the ringer volume will change.)
- **To turn the ringer OFF,** press and hold **RINGER** until 2 beeps sound.
- **To turn the ringer ON,** press **RINGER**. The ringer will sound at the HIGH level.

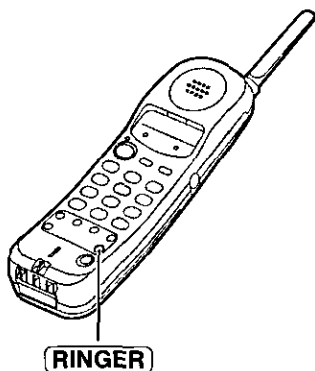

Preparation

### With the base unit

The TALK and SP-PHONE indicator lights must be off.

- **To select HIGH (preset) or LOW,** press **HOLD/RINGER**.  
(Each time you press the button, the selected volume will ring and the ringer volume will change.)
- **To turn the ringer OFF,** press and hold **HOLD/RINGER** until 2 beeps sound.
- **To turn the ringer ON,** press **HOLD/RINGER**.  
The ringer will sound at the HIGH level.

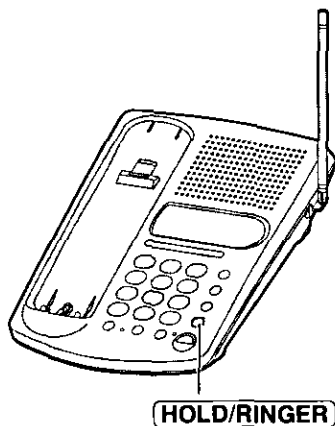

## ► Settings

---

### Using the Belt Clip

You can hang the handset on your belt or pocket using the belt clip.

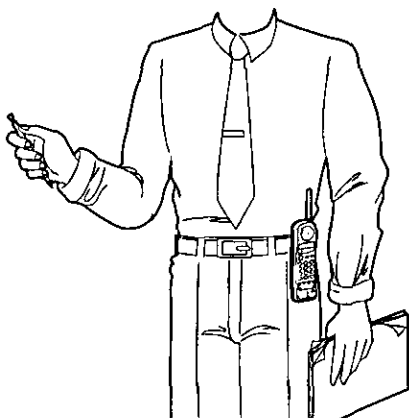

#### To install the belt clip

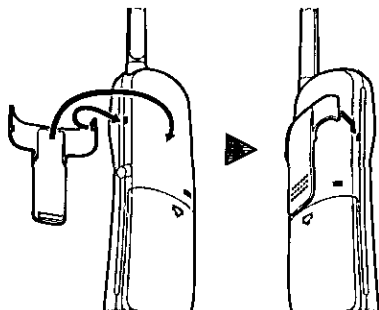

#### To remove the belt clip

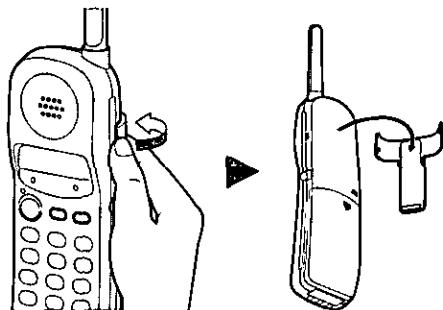

### Using the Optional Headset

Plugging an optional headset into the handset allows a hands-free phone conversation. Please use only the Panasonic KX-TCA90 headset. To order, call the accessories telephone number on page 2.

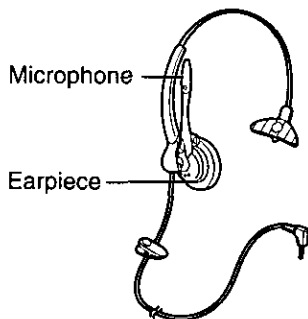

## Connecting the optional headset to the handset

Open the headset jack cover and connect the optional headset to the headset jack as shown.

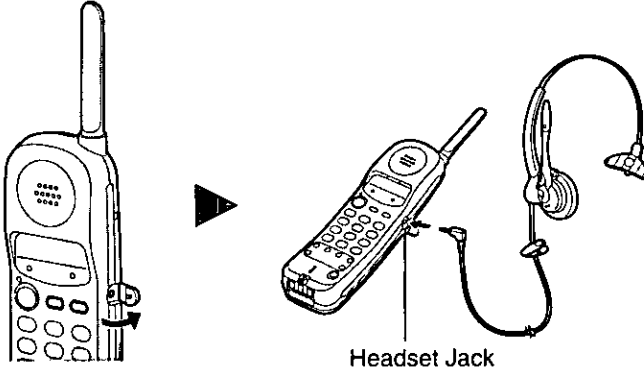

When the optional headset is connected, make sure to use the headset to talk with the caller. If you want to have a normal cordless phone conversation, disconnect the headset.

## How to wear the optional headset

- 1 Place the headset on your head and attach the clothing clip to the desired position.
- 2 Adjust the microphone to a comfortable position.
  - Place the microphone near your mouth.

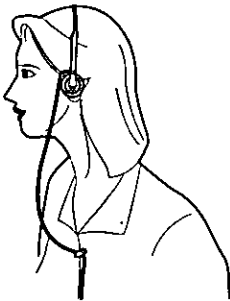

# Making Calls

To have a hands-free conversation, connect the optional headset to the handset and wear it (p. 13).

## With the Handset

- 1 Press **TALK**.
  - The TALK indicator lights.
- 2 Dial a telephone number.
- 3 To hang up, press **TALK** or place the handset on the base unit.
  - The indicator light goes out.

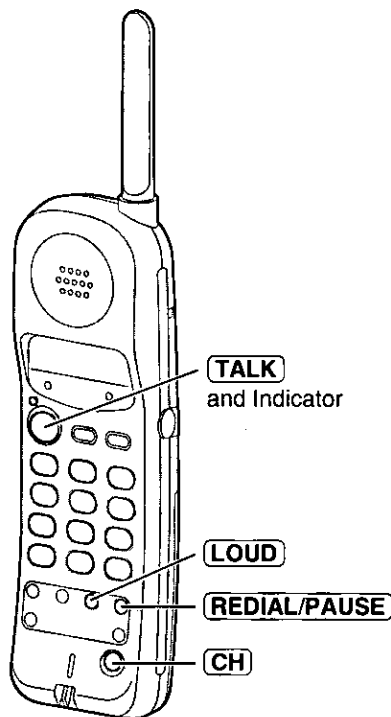

- If an alarm tone sounds in step 1, move closer to the base unit or place the handset on the base unit. Then try again.
- To switch to the speakerphone during a call with the handset, see page 20.

## To redial the last number dialed on the handset

Press **TALK** → **REDIAL/PAUSE**.



---

## To select the handset receiver volume

Press **[LOUD]** while talking.

- Each time you press the button, the volume level will change from MEDIUM (preset) to HIGH to LOW.

## If noise interferes with the conversation

Press **[CH]** to select a clearer channel or move closer to the base unit.

## Lighted handset keypad

The handset dialing buttons will light when you press a button or lift the handset off the base unit, and flash when a call is received. The lights will go out about 10 seconds after pressing a button, lifting the handset or answering a call.

## ► Making Calls

### With the Base Unit

- 1 Press **SP-PHONE**.
  - The SP-PHONE indicator lights.
- 2 Dial a telephone number.
- 3 When the other party answers, talk into the **MIC** (microphone).
- 4 To hang up, press **SP-PHONE**.
  - The indicator light goes out.

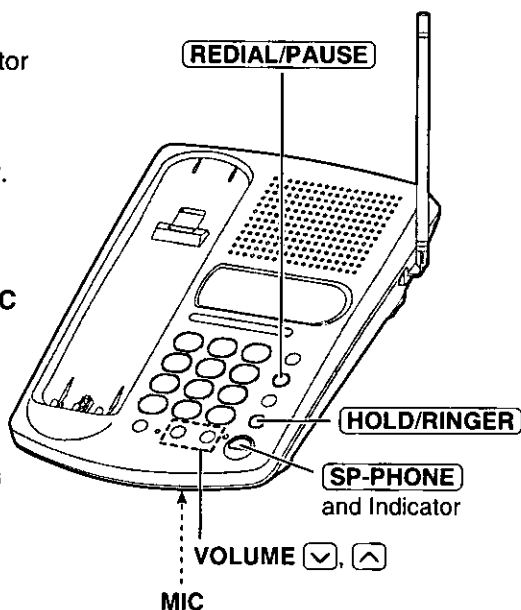

- For best speakerphone performance, use in a quiet room and talk alternately with the caller.
- If the other party has difficulty hearing you, press **VOLUME** to decrease the speaker volume. Decreasing the speakerphone volume will increase the microphone sensitivity.
- To switch to the handset while using the speakerphone:
  - If the handset is off the base unit, press **TALK**.
  - If on the base unit, just lift up.
- During a call using the handset, the call cannot be switched to the speakerphone by pressing **SP-PHONE**. To switch to the speakerphone, press **REMOTE SP** on the handset (p. 20).





## To adjust the speaker volume (12 levels) while talking

To increase, press **VOLUME** . To decrease, press **VOLUME** .

## To redial the last number dialed on the base unit

Press **SP-PHONE** → **REDIAL/PAUSE**.

## To put a call on hold

Press **HOLD/RINGER**.

- The SP-PHONE indicator flashes.

## To release the hold

From the base unit, press **SP-PHONE**.

From the handset, press **TALK** or lift the handset off the base unit.

- You may also press **REMOTE SP** on the handset to release the hold at the base unit.
- If another phone is connected on the same line (p. 30), you can also release the hold by lifting its handset.

## ➡ Making Calls

### Simultaneous Keypad Dialing

You can use the base unit like a standard telephone. After pressing **TALK** to make a call with the handset near the base unit, you can also dial using the base unit keypad.

- 1 Handset:  
Press **TALK**.
- 2 Base unit:  
Dial a telephone number while hearing a dial tone with the handset.  
◦When the other party answers, talk using the handset.
- 3 Handset:  
To hang up, press **TALK** or place the handset on the base unit.



Simultaneous Keypad Dialing is available only after pressing **REMOTE SP** (p. 21) or **TALK**.

### Useful information

You can enter numbers using the base unit keypad during a call with the handset. For example, to access an answering service, electronic banking service, etc.

1. Handset:  
Press **TALK**.
2. Handset:  
Dial a telephone number.  
◦You may also dial with the base unit keypad.
3. Base unit:  
Enter the required numbers while listening to the pre-recorded instructions.
4. Handset:  
To hang up, press **TALK** or place the handset on the base unit.

# Answering Calls

## With the Handset

If the handset is off the base unit, press **TALK**.

- You can also answer a call by pressing any dialing button **0** to **9**, **\***, or **#** (—Any Key Talk).

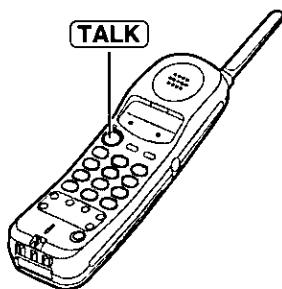

## OR

If on the base unit, just lift up.

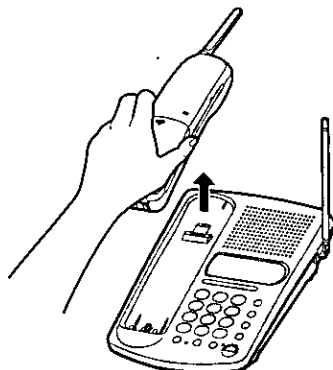

Basic Operation

When the optional headset is connected (p. 13), make sure to use the headset to talk with the caller. If you want to have a normal cordless phone conversation, disconnect the headset.

## With the Base Unit

- 1 Press **SP-PHONE**.
- 2 Talk into the **MIC**.
- 3 To hang up, press **SP-PHONE**.

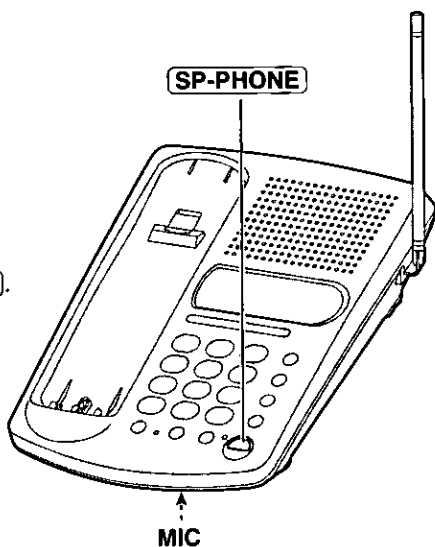

# Remote Speakerphone

You can switch a call with the handset to the speakerphone easily.

**1** Handset:  
During a call using the handset, press **REMOTE SP**.

- The call is switched to the base unit.
- The INTERCOM indicator flashes.
- The SP-PHONE indicator lights.

**2** Base unit:  
Talk into the **MIC**.

**3** Base unit:  
To hang up, press **SP-PHONE**.

- The indicator lights go out.
- You can also hang up by pressing **REMOTE SP**.

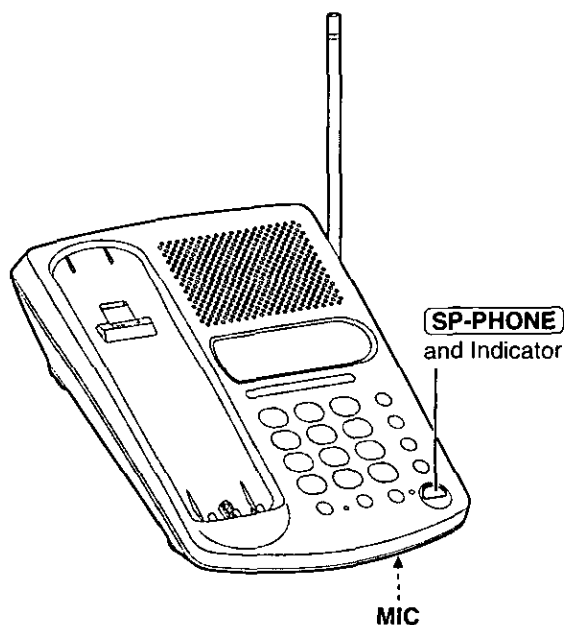
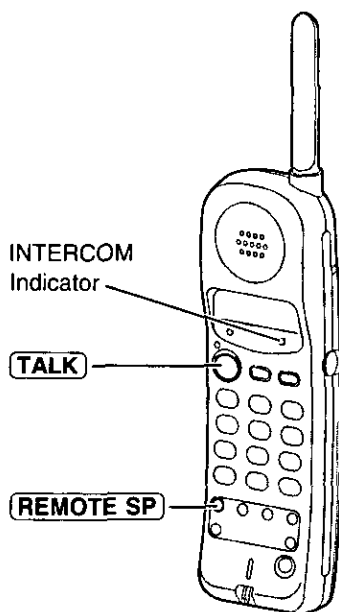

---

You can turn on the base unit speakerphone by using the handset as a remote control.

## Making calls using the handset as a remote control

1. Handset:  
Press **REMOTE SP**.
2. Handset:  
Dial a telephone number.
  - You may also dial with the base unit keypad.
3. Base unit:  
Talk into the **MIC**.
4. Handset:  
To hang up, press **REMOTE SP**.
  - You may also hang up by pressing **SP-PHONE**.

## When you redial

A number dialed with the handset keypad is saved in the handset.  
A number dialed with the base unit keypad is saved in the base unit.

## To switch to the handset (while using the remote speakerphone)

- Press **TALK**.
- You can continue the conversation using the handset.
  - To hang up, press **TALK** or place the handset on the base unit.

## Answering calls using the handset as a remote control

1. Handset:  
Press **REMOTE SP**.
2. Base unit:  
Talk into the **MIC**.
3. Handset:  
To hang up, press **REMOTE SP**.
  - You may also hang up by pressing **SP-PHONE**.

# Speed Dialer (Handset)

## Storing Phone Numbers in Memory

You can store up to 10 phone numbers in the handset. The dialing buttons (0 to 9) function as memory stations.

**The TALK indicator light must be off before programming.**

**1** Press **PROGRAM**.  
◦The TALK indicator flashes.

**2** Enter a phone number up to 22 digits.

◦If you misdial, press **PROGRAM** to end storing, then start from step 1.

**3** Press **AUTO**.

**4** Press a memory station number (0 to 9).

◦A beep sounds.  
◦To store other numbers, repeat steps 1 through 4.

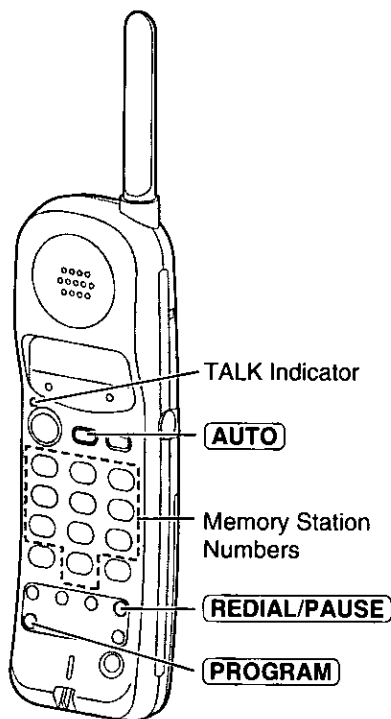

◦If a pause is required for dialing, press **REDIAL/PAUSE** where needed.  
Pressing **REDIAL/PAUSE** counts as one digit (p. 30).

## To erase a stored number

Press **PROGRAM** → **AUTO** → the memory station number (**0** to **9**) for the phone number to be erased.

## Dialing a Stored Number

- 1 Press **TALK**.
- 2 Press **AUTO**.
- 3 Press the memory station number (**0** to **9**).
  - The stored number is dialed.

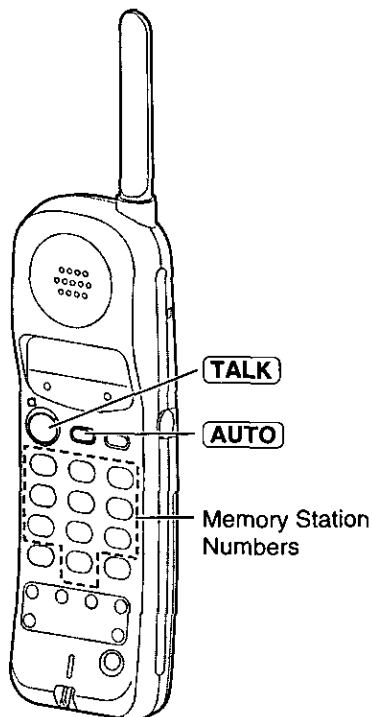

- Numbers stored in the handset can only be dialed from the handset.
- If your line has rotary or pulse service, any access numbers stored after pressing **TONE** will not be dialed.

# Speed Dialer (Base Unit)

## Storing Phone Numbers in Memory

You can store up to 5 phone numbers in the base unit. The dialing buttons (1) to (5) function as memory stations.

The **TALK** and **SP-PHONE** indicator lights must be off before programming.

- 1 Press **AUTO/PROGRAM**.
  - The **IN USE/CHARGE** indicator flashes.
- 2 Enter a phone number up to 22 digits.
  - If you misdial, press **AUTO/PROGRAM** twice to end storing, then start from step 1.
- 3 Press **AUTO/PROGRAM**.
- 4 Press a memory station number (1) to (5).
  - A beep sounds.
  - To store other numbers, repeat steps 1 through 4.

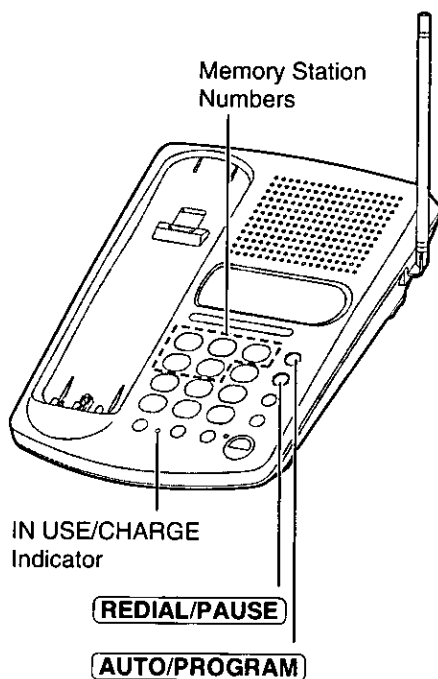

- If a pause is required for dialing, press **REDIAL/PAUSE** where needed. Pressing **REDIAL/PAUSE** counts as one digit (p. 30).



## To erase a stored number

Press **AUTO/PROGRAM** twice → the memory station number (1 to 5) for the phone number to be erased.

## Dialing a Stored Number

- 1 Press **SP-PHONE**.
- 2 Press **AUTO/PROGRAM**.
- 3 Press the memory station number (1 to 5).
  - The stored number is dialed.

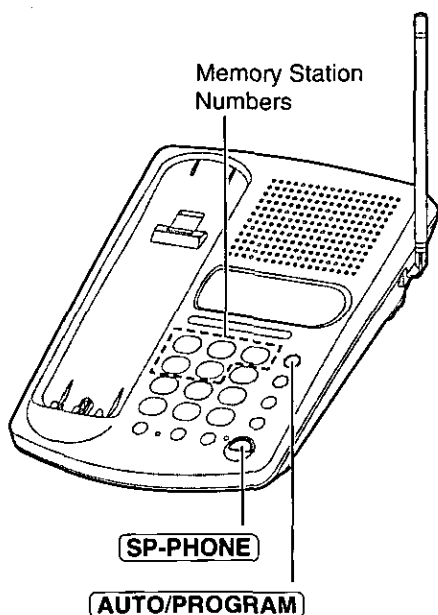

Basic Operation

- Numbers stored in the base unit can only be dialed from the base unit.
- If your line has rotary or pulse service, any access numbers stored after pressing **TONE** will not be dialed.

# Intercom

---

A 2-way intercom is possible between the handset and the base unit.

## Paging the base unit from the handset

- 1 Handset:**  
Press **INTERCOM**. Talk to the paged party after the beeps.
  - The indicator lights.
- 2 Base unit:**  
When the other party's voice is heard, answer using the **MIC**.
- 3 Handset:**  
To end the intercom, press **INTERCOM**.

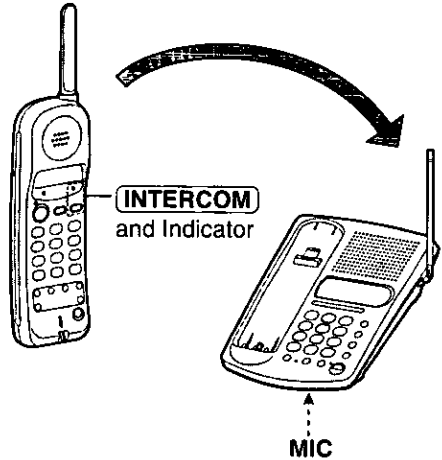

## Paging the handset from the base unit (Handset locator)

Using this feature, you can locate a misplaced handset.

- 1 Base unit:**  
Press **LOCATOR/INTERCOM**.
  - The handset beeps for 1 minute.
  - To stop paging, press **LOCATOR/INTERCOM** again.
- 2 Handset:**  
Press **INTERCOM** to answer.
- 3 Base unit:**  
Talk into the **MIC**.
- 4 Handset:**  
To end the intercom, press **INTERCOM**.

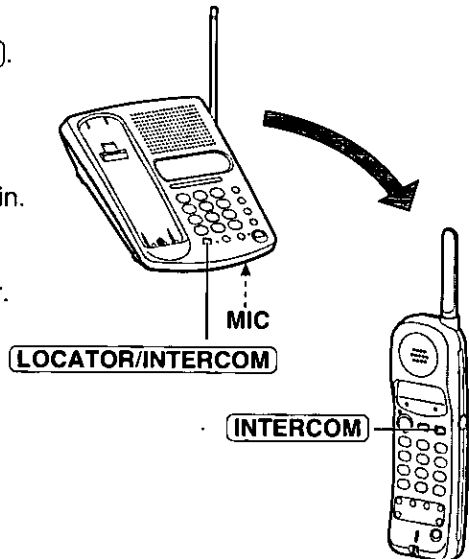

### During an intercom call:

- Intercom calls can only be ended with the handset.
- If the handset user has difficulty hearing the base unit user, decrease the base unit speaker volume by pressing **VOLUME** .
- If an incoming call is received, the intercom call stops and the unit starts to ring. To answer, press **TALK**, **REMOTE SP** or **SP-PHONE**.

## Transferring a Call Using the Intercom

The intercom can be used during a call. This feature enables you to transfer a call between the handset and the base unit.

### From the handset to the base unit

- 1** Handset:  
During a call, press **INTERCOM**. Talk to the paged party after the beeps.
  - The call is put on hold.
  - If the base unit user does not answer, press **TALK**.
- 2** Base unit:  
When the paging party's voice is heard, answer using the **MIC**.
- 3** Base unit:  
To answer the call, press **SP-PHONE**.
  - The transfer is complete.

### From the base unit to the handset

- 1** Base unit:  
During a call, press **LOCATOR/INTERCOM**.
  - The call is put on hold.
  - If the handset user does not answer, press **SP-PHONE**.
- 2** Handset:  
Press **INTERCOM** to answer the page.
- 3** Handset:  
To answer the call, press **TALK**.
  - The transfer is complete.

Advanced Operation

# Special Features

## FLASH Button

Pressing **FLASH** allows you to use special features of your host PBX such as transferring an extension call or accessing special telephone services (optional) such as call waiting.

### Selecting the flash time

The flash time depends on your telephone exchange or host PBX. You can select the following flash times: "90, 100, 110, 250, 300, 400, 600, 700 msec (milliseconds)", **using the handset near the base unit**. Your phone comes from the factory set to "700 msec".

**The TALK and SP-PHONE indicator lights must be off before programming.**

1 Press **PROGRAM**.  
•The TALK indicator flashes.

2 Press a dialing button (**1** to **8**).

<b>1</b> : 90 msec	<b>2</b> : 100 msec
<b>3</b> : 110 msec	<b>4</b> : 250 msec
<b>5</b> : 300 msec	<b>6</b> : 400 msec
<b>7</b> : 600 msec	<b>8</b> : 700 msec

3 Press **AUTO**.

4 Press **FLASH**.  
•A beep sounds.

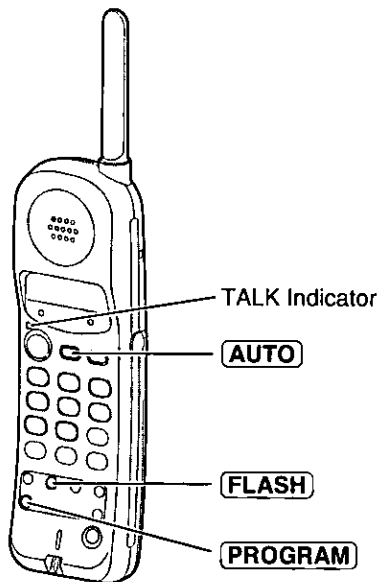

- If 3 beeps sound in step 4,
  - a wrong key was pressed. Restart from step 1.
  - the handset is too far from the base unit. Move closer to the base unit or place the handset on the base unit. Restart from step 1.
- If a power failure occurs, the setting will return to the factory preset (700 msec). Reprogram if necessary.
- If you are connected via a PBX, a longer flash time may be necessary to use PBX functions (transferring a call, etc.). Consult your PBX installer for the correct setting.

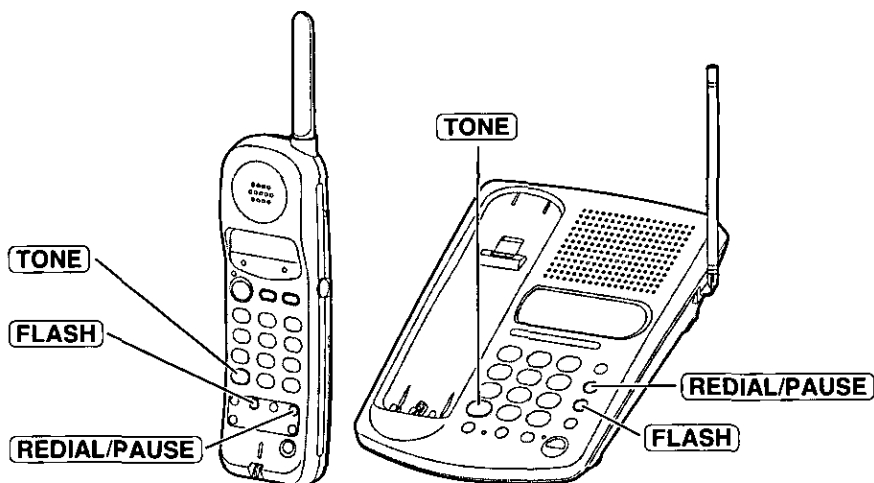

## For Call Waiting Service Users

Press **FLASH** if you hear a call-waiting tone while talking.

- The first call is put on hold and you can answer the second call.
- To return to the first caller, press **FLASH** again.
- If this function does not operate properly, the flash time may not be set correctly. Consult your telephone company. See page 28 on how to adjust the flash time.

## Automatic Security Code Setting

Each time you place the handset on the base unit, the unit automatically selects one of a million security codes. These codes help prevent the unauthorized use of your telephone line by another cordless telephone.

## Temporary Tone Dialing (For Rotary or Pulse Service Users)

Press **TONE** before entering access numbers which require tone dialing.

- The dialing mode changes to tone. You can enter numbers to access an answering service, electronic banking service, etc. When you hang up, the mode will return to pulse.
- Access numbers entered after pressing **TONE** will not be included when redialing.

## ➡ Special Features

---

### How to Use the PAUSE Button (For Analog PBX Line/Long Distance Service Users)

We recommend you press **REDIAL/PAUSE** if a pause is required for dialing with a PBX or to access a long distance service.

Ex. Line access number **9** (PBX)

**9** ⇒ **REDIAL/PAUSE** ⇒ Phone number

- Pressing **REDIAL/PAUSE** once creates a 3.5 second pause. This prevents misdialing when you redial or dial a stored number.
- Pressing **REDIAL/PAUSE** more than once increases the length of the pause between numbers.

## Adding Another Phone

---

This unit will not function during a power failure. To connect a standard telephone on the same line, use the Panasonic T-adaptor KX-J66. To order, call the accessories telephone number on page 2.

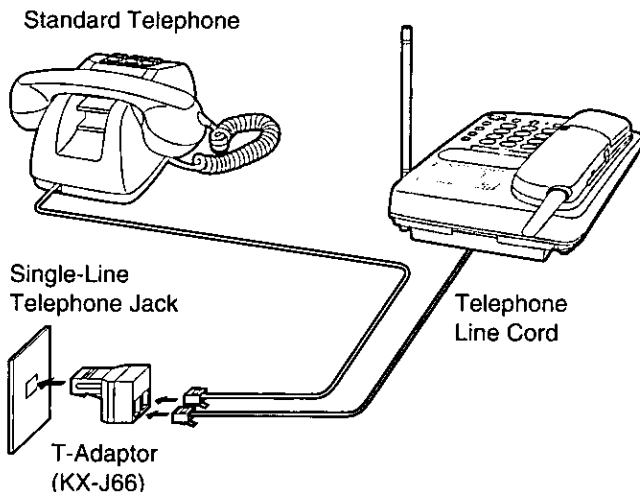

# Battery Replacement

If the RECHARGE indicator flashes after being fully charged, replace the battery with a new Panasonic P-P501 (KX-A36) battery. To order, call the accessories telephone number on page 2. To prevent memory loss, replace within 3 minutes.

- 1 Remove the cover by sliding while pressing the arrow.

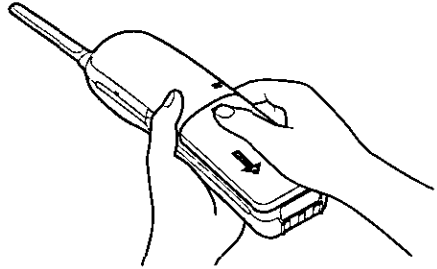

- 2 Replace the battery and close the cover.

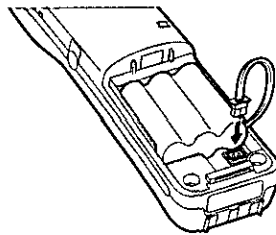

- 3 Make sure to charge the new battery for about 4 hours.

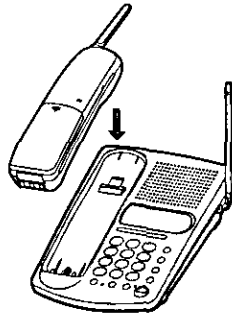

## Attention:

The product you have purchased is powered by a nickel cadmium battery which is recyclable. At the end of its useful life, under various state and local laws, it is illegal to dispose of this battery into your municipal waste stream. Please call 1-800-8-BATTERY for information on how to recycle this battery.



# Wall Mounting

---

This unit can be mounted on a wall phone plate.

- 1** Pull down the handset hook until it locks, so the tab holds the handset.

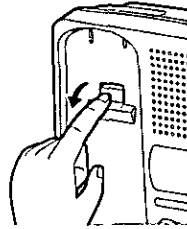

- 2** Connect the AC adaptor.

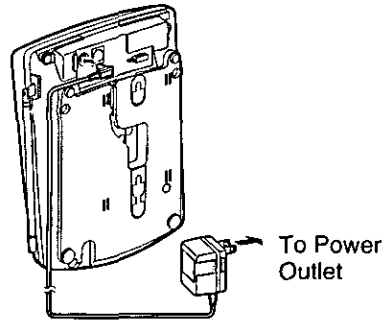

- 3** Connect the telephone line cord. Mount the unit, then slide down.  
• Raise the antenna.

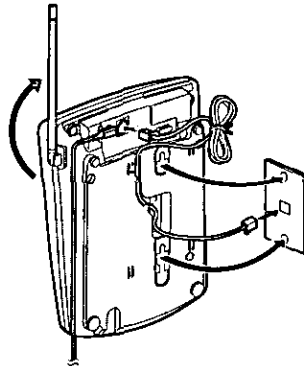

- 4** **To charge the battery:**  
Place the handset on the handset hook as shown.  
• The IN USE/CHARGE indicator lights.

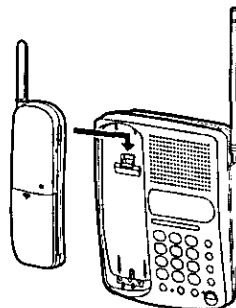



# Before Requesting Help



Problem	Remedy
The unit does not work.	<ul style="list-style-type: none"><li>• Check the settings (p. 8–13).</li><li>• Charge the battery fully (p. 9).</li><li>• Clean the charge contacts and charge again (p. 9).</li><li>• Install the battery properly (p. 31).</li><li>• Place the handset on the base unit and unplug the AC adaptor to reset. Plug in and try again.</li><li>• Re-insert the handset battery within 3 minutes to avoid memory loss and place the handset on the base unit. Try again.</li></ul>
An alarm tone sounds when you press <b>TALK</b> , <b>REMOTE SP</b> or <b>INTERCOM</b> .	<ul style="list-style-type: none"><li>• You are too far from the base unit. Move closer and try again.</li><li>• Place the handset on the base unit and try again.</li><li>• Plug in the AC adaptor.</li><li>• Raise the base unit antenna.</li></ul>
Static, sound cuts in/out, fades. Interference from other electrical units.	<ul style="list-style-type: none"><li>• Locate the handset and the base unit away from other electrical appliances (p. 3).</li><li>• Move closer to the base unit.</li><li>• Raise the base unit antenna.</li><li>• Press <b>CH</b> to select a clearer channel.</li></ul>
The handset does not ring.	<ul style="list-style-type: none"><li>• The ringer volume is set to OFF. Press <b>RINGER</b> while the TALK indicator light is off (p. 11).</li></ul>
The base unit does not ring.	<ul style="list-style-type: none"><li>• The ringer volume is set to OFF. Press <b>HOLD/RINGER</b> while the TALK and SP-PHONE indicator light are off (p. 11).</li></ul>
You cannot have a conversation using the handset.	<ul style="list-style-type: none"><li>• When the optional headset is connected, (p. 13), you must use the headset to talk with the caller. To have a normal cordless phone conversation, disconnect the headset.</li></ul>

## ► Before Requesting Help

---

Problem	Remedy
You cannot have a conversation using the optional headset.	<ul style="list-style-type: none"><li>◦ Make sure that the optional headset is connected properly (p. 13).</li></ul>
You cannot store a phone number in memory.	<ul style="list-style-type: none"><li>◦ You cannot store a number while the unit is in the talk, speakerphone or intercom mode.</li><li>◦ Do not pause for over 60 seconds while storing.</li></ul>
While storing a phone number, the unit starts to ring.	<ul style="list-style-type: none"><li>◦ To answer the call, press <b>TALK</b>, <b>REMOTE SP</b> or <b>SP-PHONE</b>. The program will be canceled. Store the number again.</li></ul>
Previously programmed information is erased.	<ul style="list-style-type: none"><li>◦ If a power failure occurs, programmed information may be erased. Reprogram if necessary.</li></ul>
<b>REDIAL/PAUSE</b> does not function properly.	<ul style="list-style-type: none"><li>◦ The button has a double function as either redial or pause. It will redial the last number dialed if pressed at the outset of a call (p. 14, 17). If another number has been dialed first, it will operate as a pause button (p. 30).</li></ul>
You cannot redial by pressing <b>REDIAL/PAUSE</b> .	<ul style="list-style-type: none"><li>◦ The redial function does not work right after storing phone numbers in the speed dialer (p. 22, 24).</li><li>◦ The redial function on the handset does not work right after programming the flash time (p. 28).</li><li>◦ Access numbers entered pressing <b>-tone</b> will not be included when redialing (p. 29).</li><li>◦ If the last number dialed on the handset was more than 32 digits long, the number will not be redialed.</li><li>◦ If the last number dialed on the base unit was more than 31 digits long, the number will not be redialed.</li></ul>

Problem	Remedy
<b>LOCATOR/INTERCOM</b> does not function.	<ul style="list-style-type: none"> <li>•The handset is too far from the base unit or is engaged in an outside call.</li> </ul>
<b>SP-PHONE</b> does not function.	<ul style="list-style-type: none"> <li>•The handset is engaged in an outside call. Wait until the IN USE/CHARGE indicator light goes out.</li> </ul>
During a call using the handset, the call cannot be switched to the speakerphone.	<ul style="list-style-type: none"> <li>•To switch a call to the speakerphone, press <b>REMOTE SP</b> on the handset (p. 20).</li> </ul>
The RECHARGE indicator flashes or the unit beeps intermittently.	<ul style="list-style-type: none"> <li>•Charge the battery fully (p. 9).</li> </ul>
You charged the battery fully, but the RECHARGE indicator flashes.	<ul style="list-style-type: none"> <li>•Clean the charge contacts and charge again (p. 9).</li> <li>•Install a new battery (p. 31).</li> </ul>
The IN USE/CHARGE indicator light never goes out while charging.	<ul style="list-style-type: none"> <li>•This is normal.</li> </ul>
If you cannot solve your problem	<ul style="list-style-type: none"> <li>•Call our customer call center at 1-800-211-PANA(7262).</li> <li>•Panasonic's e-mail address for customer inquiries: consumerproducts@panasonic.com for customers in the USA or Puerto Rico ONLY</li> </ul>

# Important Safety Instructions

---

When using this unit, basic safety precautions should always be followed to reduce the risk of fire, electric shock, or personal injury.

1. Read and understand all instructions.
2. Follow all warnings and instructions marked on this unit.
3. Unplug this unit from AC outlets before cleaning. Do not use liquid or aerosol cleaners. Use a damp cloth for cleaning.
4. Do not use this unit near water, for example, near a bathtub, washbowl, kitchen sink, or the like.
5. Place this unit securely on a stable surface. Serious damage and/or injury may result if the unit falls.
6. Do not cover slots and openings on the unit. They are provided for ventilation and protection against overheating. Never place the unit near radiators, or in a place where proper ventilation is not provided.
7. Use only the power source marked on the unit. If you are not sure of the type of power supplied to your home, consult your dealer or local power company.
8. Do not place objects on the power cord. Install the unit where no one can step or trip on the cord.
9. Do not overload wall outlets and extension cords. This can result in the risk of fire or electric shock.
10. Never push any objects through slots in this unit. This may result in the risk of fire or electric shock. Never spill any liquid on the unit.
11. To reduce the risk of electric shock, do not disassemble this unit. Take the unit to an authorized servicenter when service is required. Opening or removing covers may expose you to dangerous voltages or other risks. Incorrect reassembly can cause electric shock when the unit is subsequently used.
12. Unplug this unit from the wall outlet and refer servicing to an authorized servicenter when the following conditions occur:
  - A. When the power supply cord or plug is damaged or frayed.
  - B. If liquid has been spilled into the unit.
  - C. If the unit has been exposed to rain or water.
  - D. If the unit does not work normally by following the operating instructions. Adjust only controls covered by the operating instructions. Improper adjustment may require extensive work by an authorized servicenter.
  - E. If the unit has been dropped or physically damaged.
  - F. If the unit exhibits a distinct change in performance.
13. During thunderstorms, avoid using telephones except cordless types. There may be a remote risk of an electric shock from lightning.
14. Do not use this unit to report a gas leak, when in the vicinity of the leak.

## SAVE THESE INSTRUCTIONS

---

**CAUTION:**

To reduce the risk of fire or injury to persons, read and follow these instructions.

1. Use only the battery(ies) specified.
2. Do not dispose of the battery(ies) in a fire. They may explode. Check with local waste management codes for special disposal instructions.
3. Do not open or mutilate the battery(ies). Released electrolyte is corrosive and may cause burns or injury to the eyes or skin. The electrolyte may be toxic if swallowed.
4. Exercise care in handling batteries in order not to short the battery to conductive materials such as rings, bracelets, and keys. The battery and/or conductor may overheat and cause burns.
5. Charge the battery(ies) provided with or identified for use with this product only in accordance with the instructions and limitations specified in this manual.

**WARNING:**

TO PREVENT FIRE OR SHOCK HAZARD, DO NOT EXPOSE THIS PRODUCT TO RAIN OR ANY TYPE OF MOISTURE.

# FCC and Other Information

---

If requested by the telephone company, inform them as follows:

FCC Registration No. . . . . (found on the bottom of the unit)  
Ringer Equivalence. . . . . 0.1B  
The particular telephone line to which the equipment is connected.

This unit must not be connected to a coin operated line.

If you are on a party line, check with your local telephone company.

## **Ringer Equivalence No. (REN):**

The REN is useful in determining the quantity of devices you may connect to your telephone line and still have all of those devices ring when your telephone number is called. In most, but not all areas, the sum of the REN's of all devices connected to one line should not exceed five (5.0). To be certain of the number of devices you may connect to your line, as determined by the REN, you should contact your local telephone company to determine the maximum REN for your calling area.

In the event terminal equipment causes harm to the telephone network, the telephone company should notify the customer, if possible, that service may be stopped.

However, where prior notice is impractical, the company may temporarily cease service providing that they:

- (a) Promptly notify the customer.
- (b) Give the customer an opportunity to correct the problem with their equipment.
- (c) Inform the customer of the right to bring a complaint to the Federal Communication Commission pursuant to procedures set out in FCC Rules and Regulations Subpart E of Part 68.

The Telephone Company may make changes in its communications facilities, equipment, operations or procedures, where such action is reasonably required in the operation of its business and is not inconsistent with the rules and regulations in FCC Part 68.

If such changes can be reasonably expected to render any customer terminal equipment incompatible with telephone company communications facilities, or require modification or alteration of such terminal equipment, or otherwise materially affect its use or performance, the customer shall be given adequate notice in writing, to allow the customer an opportunity to maintain uninterrupted service.

When programming emergency numbers and/or making test calls to emergency numbers:

1. Remain on the line and briefly explain to the dispatcher the reason for the call before hanging up.
2. Perform such activities in the off-peak hours, such as early morning hours or late evenings.

---

This device complies with Part 15 of the FCC Rules. Operation is subject to the following two conditions: (1) This device may not cause harmful interference, and (2) this device must accept any interference received, including interference that may cause undesired operation.

Privacy of communications may not be ensured when using this phone.

**CAUTION:**

Any changes or modifications not expressly approved by the party responsible for compliance could void the user's authority to operate this device.

**Note:**

This equipment has been tested and found to comply with the limits for a Class B digital device, pursuant to Part 15 of the FCC Rules. These limits are designed to provide reasonable protection against harmful interference in a residential installation. This equipment generates, uses, and can radiate radio frequency energy and, if not installed and used in accordance with the instructions, may cause harmful interference to radio communications. However, there is no guarantee that interference will not occur in a particular installation. If this equipment does cause harmful interference to radio or television reception, which can be determined by turning the equipment off and on, the user is encouraged to try to correct the interference by one or more of the following measures:

- Reorient or relocate the receiving antenna.
- Increase the separation between the equipment and receiver.
- Connect the equipment into an outlet on a circuit different from that to which the receiver is connected.
- Consult the dealer or an experienced radio/TV technician for help.

Some cordless telephones operate at frequencies that may cause interference to nearby TVs and VCRs. To minimize or prevent such interference, the base of the cordless telephone should not be placed near or on top of a TV or VCR. If interference is experienced, move the cordless telephone further away from the TV or VCR. This will often reduce or eliminate interference.

- **Environment**—do not place the unit in a room where the temperature is less than 5°C (41°F) or greater than 40°C (104°F). Allow 10 cm (4") clearance around the unit for proper ventilation. Avoid excessive smoke, dust, mechanical vibration, shock, or direct sunlight.
- **Routine care**—wipe the unit with a soft cloth. Do not use benzine, thinner, or any abrasive powder. When you leave the unit unused for a long period of time, unplug the AC adaptor from the outlet.
- **If there is any trouble**—disconnect the unit from the telephone line and connect a known working phone. If the known working phone operates properly, have your unit repaired by one of the authorized Panasonic Factory Service Centers. If the known working phone does not operate properly, consult your telephone company.

## For product service

- Call 1-800-211-PANA(7262) or 1-800-833-9626 for the location of an authorized servicenter.
- Panasonic's e-mail address for customer inquiries:  
consumerproducts@panasonic.com  
for customers in the USA or Puerto Rico ONLY

## When you ship the product

- Carefully pack your unit, preferably in the original carton.
- Attach a letter, detailing the symptom, to the outside of the carton.

### Symptom

---

- Send the unit to an authorized servicenter, prepaid and adequately insured.
- Do not send your unit to the Panasonic Consumer Electronics Company listed below or to executive or regional sales offices. These locations do not repair consumer products.

- This cordless telephone is designed for use in the United States of America. Sale or use of this product in other countries may violate local laws.
- Ce téléphone sans fil est conçu pour être utilisé aux États-Unis d'Amérique. La vente ou l'emploi de cet appareil dans certains autres pays peut constituer une infraction à la législation locale.
- Este teléfono sin cordón fue elaborado para uso en los Estados Unidos de América. La venta o el empleo de este producto en ciertos países puede constituir violación de la legislación local.
- このコードレス電話機は、日本国外での使用を目的として設計されており、日本国内での使用は法律違反となります。従って、当社では日本国内においては原則として修理などのサービスは致しかねます。

**Panasonic Consumer Electronics Company,  
Division of Matsushita Electric Corporation of America**  
One Panasonic Way, Secaucus, New Jersey 07094

**Panasonic Sales Company,  
Division of Matsushita Electric of Puerto Rico, Inc.**  
Ave. 65 de Infantería, Km. 9.5, San Gabriel Industrial Park  
Carolina, Puerto Rico 00985