

# Panasonic

# SUBSCRIBER'S GUIDE

*Please read before using.*

MODEL

---

KX-TVP200E

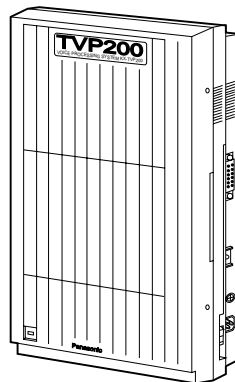

# Introduction

The Panasonic Voice Processing System (VPS) provides you with powerful, convenient ways to manage your voice communications and increase your productivity through your voice mailbox. As the owner of a VPS mailbox, or Subscriber, you can:

- send a message to one or many people inside or outside of your office
- transfer messages (with your annotation) to another VPS Subscriber
- take messages when you are on the phone or unavailable
- receive your messages from any touch-tone telephone
- be notified by extension message waiting lamp, telephone or beeper (radio pager) of messages waiting
- screen your calls
- automate the handling of callers
- and more...

This guide is your reference to using and optimizing your VPS mailbox.

## NOTE:

- This Subscriber's Guide does not show complete model numbers that indicate the country where your models should be used. The model number of your unit is found on the label affixed to the unit.

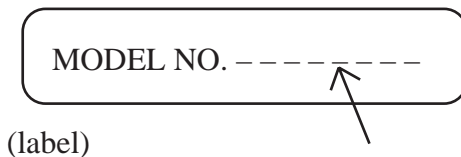

**CE**  
73/23/EEC  
89/336/EEC  
92/31/EEC  
93/68/EEC

## ■ How to Use this Manual

This Subscriber's Guide explains the Voice Processing System's (VPS) operations by touch tone telephone for Subscribers.

Each operation consists of a description, a diagram, tips and some notes. During operations, the VPS plays voice prompts telling you what to do at each step though they do not appear in this guide except for Voice Mail Service Entry.

### Description

Describes the operation with the telephone keys to be pressed step by step.

### Diagram

A diagram is provided for each function on the lefthand of the text. It will help you understand how the operation goes on in the tree-structured VPS menu. You will know other options you can choose in a certain step. It will also help you to perform your desired operation faster if you press the outlined keys in a row along the bold line.

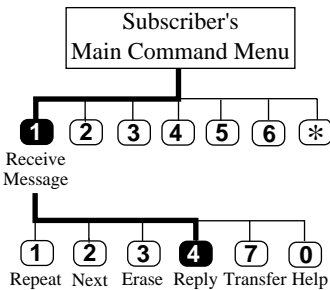

### Tip

**Step 3** —  
You can call the message sender by pressing [1].

### Tip

Tips framed in a square are used to make you aware of alternate options available at a particular step.

### ► Note

This symbol describes additional information or useful advice about each feature.

Once you become familiar with operating the VPS, use the Quick Reference Section, which appears at the end of this guide.

## ■ Terms to Know

The following words are used in this guide.

- Subscriber**            The owner of a VPS mailbox. The System Manager can create a mailbox for you.
- System Manager**    The System Manager is the person who manages and maintains the VPS to make it work efficiently. He controls mailbox creating and authorizes some of the features.
- Caller**                 A caller is any person who is connected to a VPS service other than a Subscriber or the System Manager.

## ■ Getting Started

### — Required Numbers

Get the following information before you begin the operation.

- (1) Telephone Number Directly Connected to Voice Mail Service  
If your VPS does not have one, call any extension number connected to the VPS and press [#] [6] (Service Access Command).
- (2) Your Mailbox Number  
Usually, the same number as your extension number. Check with your System Manager to be sure.
- (3) The System Manager's Phone Number  
In case you need his or her help or need to change certain mailbox settings.

### — Basic Steps

You need to know your mailbox number to use this guide.

If you are going into your mailbox for the first time, read Chapter 5 “Mailbox Setup” first. You need to customize it before sending or receiving messages. Especially, it is important to identify yourself as the owner of the mailbox by setting the following.

- Recording Personal Greetings (See page 5-7)
- Recording Your Name (See page 5-9)
- Changing Your Password (See page 5-8)

Then customize it as it suits you by setting the additional features as appropriate.

- Setting the Call Transfer Status (See page 5-2)
- Setting the Incomplete Call Handling Status (See page 5-4)
- Message Waiting Lamp Notification Setting (See page 5-13)
- Setting Notification by Calling (See page 5-14)

...

Once you complete your setting, find your desired operation from the titles, then call the VPS.

# Table of Contents

## Chapter 1 Using Your Mailbox and the VPS

Opening Your Mailbox (Mailbox Log in) .....	1-2
Accessing VPS Services .....	1-3

## Chapter 2 Receiving Messages

Receiving Messages .....	2-2
Message Playback Options .....	2-3
Replying to Messages .....	2-5
Message Transfer .....	2-6
Erasing Messages .....	2-7
Receiving Message Waiting Notification .....	2-8
Live Call Screening.....	2-9
Recording a Two-Way Conversation .....	2-10

## Chapter 3 Sending Messages

Delivering Messages to Other Subscribers .....	3-2
Checking Mailbox Distribution .....	3-3
Setting up an External Message Delivery List .....	3-4
Sending External Delivery Messages .....	3-6
Checking and Setting External Message Delivery Status .....	3-7

## Chapter 4 Caller Handling

Recording Messages (for any caller) .....	4-2
Recording Messages (from a rotary phone) .....	4-3
Receiving External Delivery Messages .....	4-4
Replying to External Delivery Messages .....	4-5

# Chapter 5 Mailbox Setup

Setting the Call Transfer Status (Call Block/Call Screening/Intercom Paging/Beeper Access) .....	5-2
Setting up a Covering Extension .....	5-3
Setting the Incomplete Call Handling Status .....	5-4
Setting the Message Reception Mode .....	5-6
Recording Personal Greetings .....	5-7
Changing Your Password .....	5-8
Recording Your Name .....	5-9
Entry of Personal Group Distribution Lists .....	5-10
Recording the Names of Personal Group Distribution Lists .....	5-11
Deleting from Personal Group Distribution Lists .....	5-12
Message Waiting Lamp Notification Setting .....	5-13
Setting Notification by Calling .....	5-14
Setting Answer Lengths for the Interview Mailbox .....	5-16
Recording Questions for the Interview Mailbox .....	5-17
Erasing Questions from the Interview Mailbox .....	5-18

# Chapter 1

## Using Your Mailbox and the VPS

This chapter tells you how to enter Subscriber Service and other services provided by the VPS.

### Contents

<b>Opening Your Mailbox (Mailbox Log in) .....</b>	<b>1-2</b>
<b>Accessing VPS Services .....</b>	<b>1-3</b>



# Opening Your Mailbox (Mailbox Log in)

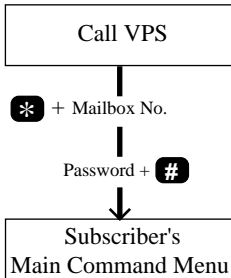

- ▶ If you just want to record a message in someone else's mailbox, you do not have to use this procedure. See the following topic in Chapter 4.
  - Recording Messages (for any caller)
  - Recording Messages (from a rotary phone)
- ▶ If your company is using a Panasonic KX-TD series telephone system, you can directly access your mailbox just by dialing the number of the V.M. Service, depending upon System Programming. Check with your System Manager.

## Tip

### Step 1 —

If no ports are assigned to Voice Mail Service, press **# 6** after calling the VPS.

To access Subscriber Services, you must open your mailbox first. Follow the operation below.

- 1** Dial **an extension number** which is connected to the Voice Mail Service.

*Good morning/Good afternoon/Good evening  
Welcome to the Voice Processing System.*

If the system is equipped with multiple languages (up to three languages), you will hear a selection prompt as follows.

(ex.)

*For English, press [7].  
For French, press [8].  
For Chinese, press [9].*

- 2** If you hear the above prompt, press the number of the appropriate language.

*Please enter your party's mailbox number.  
To enter by name, press [#] and [1].  
If you are using a rotary telephone, stay on the line.  
To call the operator, press [0].*

- 3** Press **\***, then enter **your mailbox number**.

*Enter your password, followed by [#].*

- 4** Enter **the password** if you have one. You are now in **the main command menu**.

# Accessing VPS Services

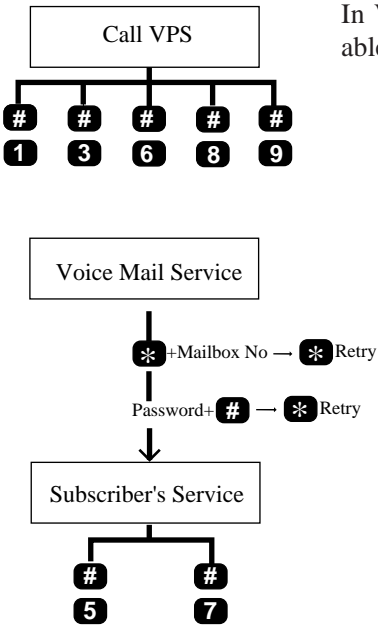

## Tip

# 5 and # 7 are valid only for Subscriber Service.

In VPS operation, the following functions are available whenever the system is providing voice prompts.

Press the appropriate key to receive your desired option (Service Access Commands).

## Dialing by Name

If you press # 1, you can call the desired extension or mailbox by entering first 3 or 4 letters of the person's last name.

## Department Dialing

If you press # 3, you can call the intended extension and mailbox by pressing one digit (1–9) according to the Department Dialing Menu.

## Voice Mail Service

If you press # 6, you can access the Voice Mail Service.

## Call Transfer

If you press # 8, you can access the Automated Attendant Service and call your desired extension.

## Exit the Menu

If you press # 9, you can exit the VPS.

## Back up

If you press \*, you can retry to enter a mailbox number, a password and also an extension number while you are in the call transfer status. In addition, you can move back to a previous menu in the main command menu.

# Accessing VPS Services

---

## Log in

If you press **# 5**, you can reselect a mailbox while you are in the main command menu.

## Restart

If you press **# 7**, you can be back in the initial main command menu.

# Chapter 2

## Receiving Messages

This chapter tells you how to access and manage received messages: Replying immediately, transferring messages with or without an additional comment, and replaying messages.

### Contents

<b>Receiving Messages .....</b>	<b>2-2</b>
<b>Message Playback Options .....</b>	<b>2-3</b>
<b>Replying to Messages .....</b>	<b>2-5</b>
<b>Message Transfer .....</b>	<b>2-6</b>
<b>Erasing Messages .....</b>	<b>2-7</b>
<b>Receiving Message Waiting Notification .....</b>	<b>2-8</b>
<b>Live Call Screening .....</b>	<b>2-9</b>
<b>Recording a Two-Way Conversation .....</b>	<b>2-10</b>

# Receiving Messages

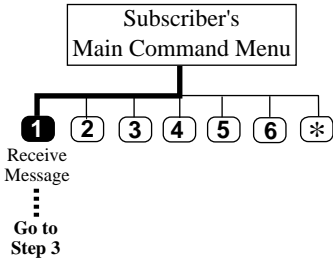

The VPS plays new messages and saved messages in your mailbox with the information of the message sender and the recorded date respectively.

- 1** Log in **the main command menu.**
  - The VPS tells you the number of messages.
- 2** Press **1** to use the Receive Message menu.
  - The VPS tells you the number of messages. Then it plays the messages.
- 3** Press **0** to listen to the whole menu (for Help).
  - You can end your call by pressing **# 9**.

Receiving Messages

## Tip

### Step 3 —

You do not have to listen to the whole menu if you do not wish to.

- 1** Repeat this message
- 1 1** Play the previous message
- 2** Play the next message
- 3** Erase this message
- 4** Reply
- 5** Rewind
- 6** Fast forward
- 7** Transfer
- 8** Message scan

# Message Playback Options

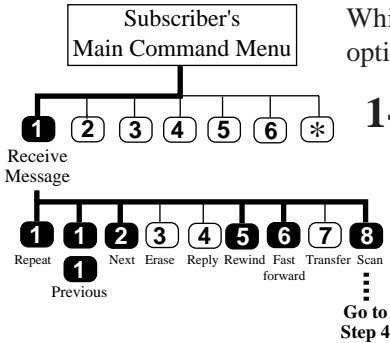

While receiving messages, several message playback options are available for efficient receiving.

**1-2** Same as **Receiving Messages**.

**3** Press the appropriate key to receive your desired option. If you choose **8**, go to the next step.

## Repeating Messages

If you press **1**, you can listen to the current message again.

## Replaying the Previous Message

If you press **1** **1** while receiving a message, you can listen to the previous message.

## Playing the Next Message

If you press **2** while receiving a message, you can listen to the next message.

## Rewinding Messages

If you press **5** while receiving a message, you can listen to it again.

## Fast Forwarding Messages

If you press **6** while receiving a message, you can fast forward it to the end.

## Scanning Messages

If you press **8**, you can listen to the first four seconds of each message.

# Message Playback Options

---

- 4 Messages are scanned one at a time.
  - If you press **1**, you will hear the previous message.
  - If you press **2**, you will hear the next message.
  - If you press **3**, you will hear the entire message.

- **Note**
  - Option **3** is available only once. Second time will erase the message.

## Tip

**Step 3** —  
You can receive the whole menu by pressing [0] for Help.

# Replying to Messages

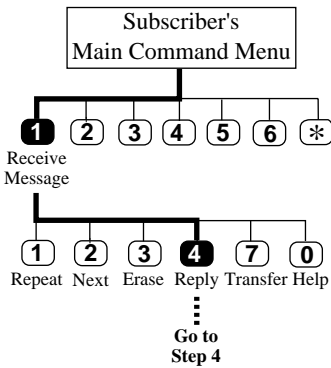

- ▶ This feature is available only when the message has been delivered from a Subscriber using his mailbox, i.e., Message Transfer and Message Delivery. Otherwise, you will hear this prompt: *"Sorry, you cannot reply. The message sender is unknown."*

- 1-2 Same as **Receiving Messages**.
- 3 Press **4** to reply to the message.
- 4 Press **2** to record a message.
- 5 Record **your message** at the tone.
- 6 Press **1** to end recording.
- 7 Press **2** to accept.
- 8 Press **1** to set delivery time.
- 9 Press **1** to specify the delivery time or the private status.
- 10 Press **1** to specify the delivery time.
- 11 Enter **the time** and **#**.
- 12 Press **1** for AM or **2** for PM.
- 13 Enter **the date** (the day of the month) and **#**.
- 14 Press **2** to accept.
- 15 Press **1** to set this message to a private message. Otherwise, press **2**.

## Tip

### Step 4 —

You can call the message sender by pressing [1].

### Step 6 —

You can pause/restart recording by pressing [2].

### Step 9 —

You can make your reply immediate by pressing [2].

You will skip to step 15.

### Step 11 —

If you press [0] for help here, *"For example, to enter 5 o'clock press [5] and [#] or 5 : 15 press [5], [1], [5] and [#]"*.



# Message Transfer

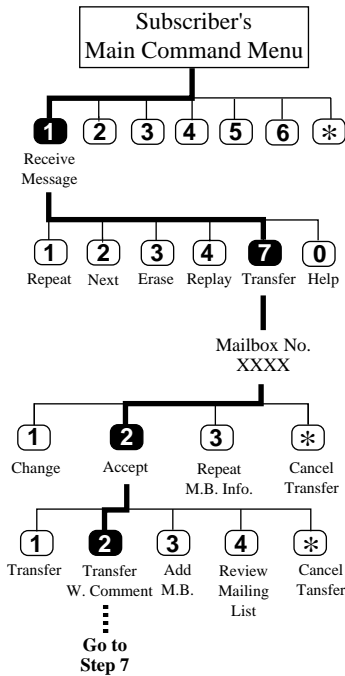

This function allows you to transfer messages to other mailboxes.

- 1-2** Same as **Receiving Messages**.
- 3** Press **7** to use the Message Transfer menu.
- 4** Enter **the mailbox number** of the intended recipient.
- 5** Press **2** to accept.
- 6** Press **2** to record a comment.
- 7** State **your comment** and press **1** to end recording.
- 8** Press **2** if the comment is acceptable.

- ▶ If the message has been assigned as private, you cannot transfer it to other mailboxes.

## Tip

### Step 4 —

You can enter by name by pressing [#] [1] first. Also, you can specify a Personal Group Distribution List or a System Group Distribution List by entering the number followed by [#].

### Step 6 —

You can transfer the message without comment by pressing [1].

You can add the mailbox number by pressing [3].

You can review the mailing list by pressing [4].

You can cancel message transfer by pressing [\*].

### Step 7 —

You can press [2] to pause/restart recording.

### Step 8 —

You can press [3] to change your comment.

You can press [1] to review your comment.

# Erasing Messages

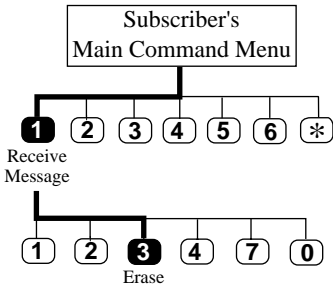

- ▶ The VPS will automatically erase messages after a certain number of days. Check with your System Manager to find out how many days you can keep messages in your mailbox.

You can erase messages during playback. Erased messages cannot be recovered.

- 1 Log in **the main command menu**.
  - The VPS tells you the number of messages.
- 2 Press **1** to use the Receiving Messages menu.
  - The VPS tells you the number of messages, and the message information. Then it plays the message.
- 3 Press **3** to erase the messages.

## Tip

### Step 3 —

Messages are erased one at a time. After a message is erased, you will hear the following prompt and repeat step 3 for the next message.

*"The message is erased."*

If all messages have been erased, you will hear *"All messages are erased"*.

# Receiving Message Waiting Notification

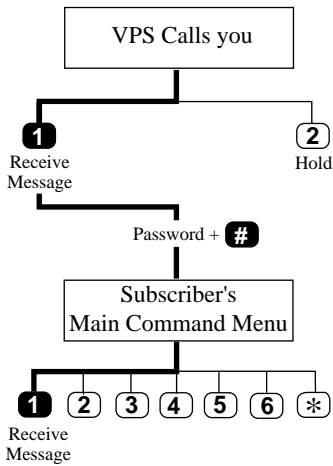

The Message Waiting Notification is a feature to notify you that unplayed messages are waiting in your mailbox. Notification Calls are sent to you via specified device after the message is recorded.

**1** Pick up a call from the VPS.

If the system is equipped with multiple languages (up to three languages), you will hear a selection menu.

**2** Press **1** to receive the message.

**3** Enter **the password** and **#**.

Now, you are in **the main command menu**.

**4** Follow steps 2 – 3 of **Receiving Messages**.

## Tip

**Step 3** —

If a password is not assigned, skip this step.

# Live Call Screening

---

By assigning one of your telephone keys to this feature, you can monitor incoming calls that have been forwarded to the Voice Mail Service.

In Hands-Free Mode, you can monitor the incoming call through built-in speaker of the telephone. Also, you can speak with the caller by picking up the handset.

In Private Mode, you can monitor the incoming call by going off-hook after you hear the notification tone. You can speak with the caller by pressing the feature key. Or you can stop listening to the message by going on-hook.

- ▶ This feature is available only if your company is using a Panasonic KX-TD series telephone system.

**Note :**

For detailed information, please refer to the Installation Manual of Panasonic KX-TD series telephone systems' PBXs (KX-TD816, KX-TD1232).

# Recording a Two-Way Conversation

---

- ▶ This feature is available only if your company is using a Panasonic KX-TD series telephone system.
- ▶ A beep sounds every sixteen seconds during recording.

By assigning one of the function keys on your telephone to this feature, you can record the conversation that you are having.

When you record your two-way telephone conversation, you should inform the other party that the conversation is being recorded.

# Chapter 3

## Sending Messages

This chapter tells you how to send messages, including recording and delivery.

### Contents

<b>Delivering Messages to Other Subscribers .....</b>	<b>3-2</b>
<b>Checking Mailbox Distribution .....</b>	<b>3-3</b>
<b>Setting up an External Message Delivery List.....</b>	<b>3-4</b>
<b>Sending External Delivery Messages .....</b>	<b>3-6</b>
<b>Checking and Setting External Message Delivery Status .....</b>	<b>3-7</b>

# Delivering Messages to Other Subscribers

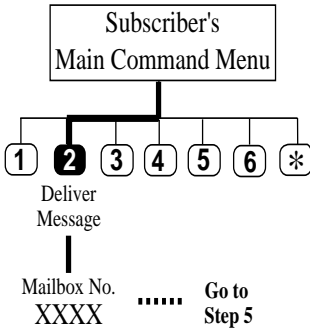

- ▶ To use Personal Group Distribution Lists, they must have been created beforehand. To use the System Group Distribution Lists, check with your System Manager to see if there is any list in your VPS.

## Tip

### Step 3 —

You can enter by name if you press [#] [1] first. Also, you can specify a Personal Group Distribution List or a System Group Distribution List by entering the number followed by [#].

### Step 4 —

You can review the mailing list by pressing [3].

### Step 6 —

You can press [2] to pause recording while you are in the message recording process. Restart the recording within 20 seconds, or the VPS will stop it automatically.

### Step 9 —

You can deliver the message immediately and return to the main command menu by pressing [2].

### Step 10 —

You can deliver your message immediately after recording by pressing [2]. Then you will skip to step 14.

### Step 11 —

You can press [0] for Help menu. It will guide you how to enter the time.

If you are sending an identical message to several Subscribers, follow the steps below.

You can send it with a single operation.

- 1 Log in **the main command menu**.
  - The VPS tells you the number of messages.
- 2 Press **2** for Message Delivery.
- 3 Enter **the mailbox number** of the intended recipient.
- 4 Press **2** to accept the mailbox number if it is correct.

You can add mailbox numbers by pressing **2**. Then repeat step 3 and step 4. You can specify a maximum of 20 mailboxes as the destination.

- 5 Press **1** to record a message.
- 6 State **your message** at the tone.
- 7 Press **1** to end recording.
- 8 Press **2** to accept.
- 9 Press **1** to set delivery time or private status.
- 10 Press **1** to specify the delivery time.
- 11 Enter **the time** and **#**.
- 12 Press **1** for AM or **2** for PM.
- 13 Enter **the date** (the day of the month) and **#**.
- 14 Press **2** to accept.
- 15 Press **1** to set this message to a private message. Otherwise, press **2**.

# Checking Mailbox Distribution

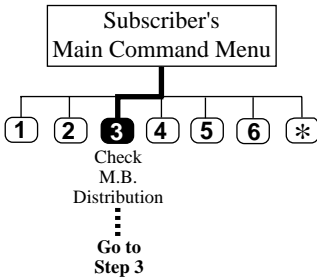

This function lets you check the status of messages which you have recorded in your mailbox to deliver to other mailboxes.

You can check the history (delivery status) of up to 84 message transmissions.

- 1 Log in **the main command menu**.
- 2 Press **3** to check distribution status.
- 3 Press **3** to cancel the message or delete verification.
- 4 Select **1** to delete verification of this message or **2** to cancel message delivery.

## Tip

### Step 3 —

You can listen to the message by pressing [1].  
You can check the previous message by pressing [1] twice.  
You can check the next message by pressing [2].



# Setting up an External Message Delivery List

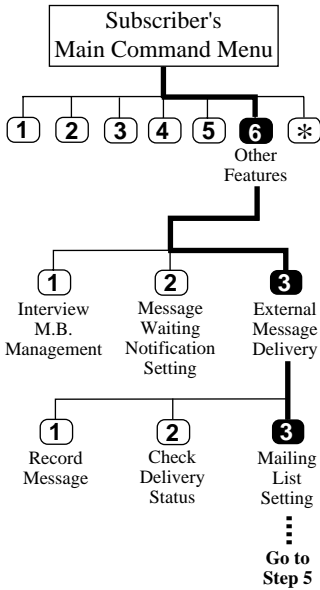

► To use this feature, you must have your System Manager authorize it beforehand.

## Tip

### Step 8 —

- 1 Change the telephone number
- 2 Accept
- 3 Review
- 4 Add more digits
- 5 Insert a pause
- 6 Set dial mode
- 7 Insert a wait for dial tone

Setting up an External Message Delivery List lets you send the same message to several people outside of the system with a single operation. Up to two lists can be maintained at the same time, and each list can contain up to eight members.

- 1 Log in **the main command menu**.
- 2 Press **6** for Other Features.
- 3 Press **3** for External Message Delivery.
- 4 Press **3** to set up the mailing list.
- 5 Press **1** or **2** to choose the delivery list.  
(Up to two delivery lists can be established.)

## To add members:

- 6 Press **1** to add members to the list.  
You can have up to 8 members on the list.
- 7 Enter **the telephone number**.
- 8 Press **2** to accept the number.
- 9 Record **the name** and press **1**.
- 10 Press **2** to accept.
- 11 Press **1** to continue adding members or **2** to end.

If you press **1**, you will repeat steps 7 – 11.

# Setting up an External Message Delivery List

---

## To delete members:

Go to the Delivery List Menu.

(See steps 1 – 5 in “Setting up an External Message Delivery List”.)

- 6 Press **2** to delete members from the list.
- 7 Press **1** to delete all members from the list. Otherwise, press **2**.
- 8 Press **1** to delete the number, or **2** to keep the number and play the next telephone number.

# Sending External Delivery Messages

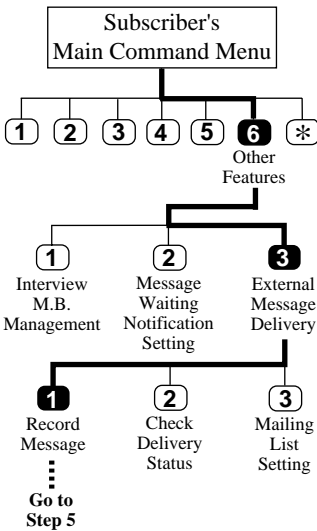

- To use this feature, you must have your System Manager authorize it beforehand.

## Tip

### Step 5 —

You can press [2] to send your message by mailing list 1 or 2.

### Step 7 —

- 1** Change the telephone number
- 2** Accept
- 3** Review
- 4** Add more digits
- 5** Insert a pause
- 6** Set dial mode
- 7** Insert a wait for dial tone

### Step 10 —

You can press [0] for Help menu. It will guide you how to enter the time.

- 1** Log in the main command menu.
- 2** Press **6** for Other Features.
- 3** Press **3** for External Message Delivery.
- 4** Press **1** to record an external delivery message.
- 5** Press **1** to send to a receiver.
- 6** Enter the telephone number.
- 7** Press **2** to accept the number.
- 8** Enter the password.
- 9** Record recipient's name and press **1**.
- 10** Enter the time and press **#**.
- 11** Press **1** for AM or **2** for PM.
- 12** Enter the date and press **#**.
- 13** Review your setting and press **2** to accept the setting.
- 14** Record your message.  
(See **Recording Messages**.)

# Checking and Setting External Message Delivery Status

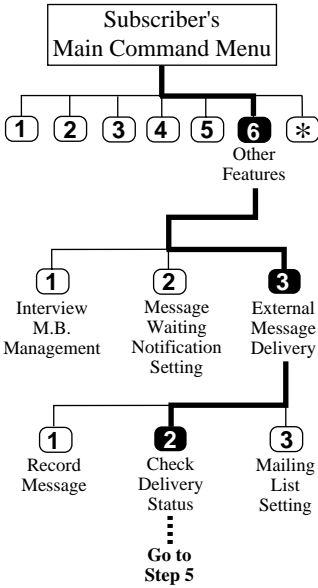

► To use this feature, you must have your System Manager authorize it beforehand.

After recording your external delivery messages, you may want to check the delivery schedules or the recipients. You can listen to the report from the VPS unless the messages have been delivered yet. After listening, you have the option of deleting unnecessary ones or changing the schedules.

- 1 Log in the main command menu.
- 2 Press **6** for Other Features.
- 3 Press **3** for External Message Delivery.
- 4 Press **2** to check External Message Delivery status.
  - The VPS tells you when the message is being sent.
- 5 Press **1** to reschedule the setting.
- 6 Press **1** to cancel the external message delivery.

(To change the time and date, press **2**. See **Sending External Delivery Messages** steps 10 to 13.)

## Tip

**Step 3** — You can skip the Help menu.

**Step 5** — You can play the next schedule by pressing [2], repeat this schedule by pressing [3] or play the previous schedule by pressing [4].

**Step 6** — If you press [\*] twice, you will return to the External Message Delivery menu.

# Chapter 4

## Caller Handling

This chapter describes how callers can be handled by the Subscriber's mailbox.

### Contents

<b>Recording Messages (for any caller) .....</b>	<b>4-2</b>
<b>Recording Messages (from a rotary phone) .....</b>	<b>4-3</b>
<b>Receiving External Delivery Messages .....</b>	<b>4-4</b>
<b>Replying to External Delivery Messages .....</b>	<b>4-5</b>

# Recording Messages (for any caller)

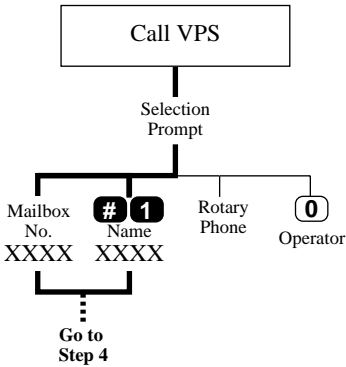

Anyone who reaches the Voice Mail Service can record messages in the mailboxes.

- 1 Call the VPS and access the Voice Mail Service.  
  
If the system supports multilingual service (up to three languages), you will hear a selection menu.
- 2 If you hear the above prompt, press **the number of the appropriate language**.
- 3 Enter **the mailbox number** of the intended recipient.  
To enter by name, press **# 1** and first 3 or 4 letters of the recipient last name.
- 4 State **your message** at the tone.
- 5 Press **1** to end recording.
- 6 Press **2** to accept.
- 7 Press **1** to set this message to a private message. Otherwise, press **2**.

**Tip**

**Step 3, 6 —**  
When the beeper callback no. entry mode is not disabled, the VPS will ask you a callback number according to the intended mailbox setting; before recording a message, after recording a message or after selecting an urgent message.  
*“Please enter your callback number.  
You can enter up to ... digits.”*

- 1 Enter the number.
- 2 Press **2** to accept.

**Step 6 —**

- 1** Review
- 2** Accept
- 3** Record a new one
- 4** Add
- \*** Erase and exit

# Recording Messages (from a rotary phone)

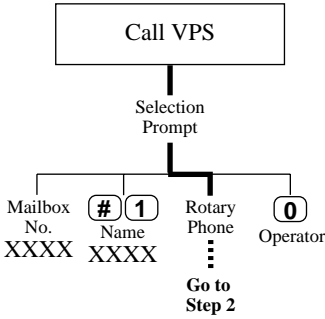

If you are using a rotary phone, you cannot specify a mailbox because every key entry is invalid. Wait a moment until the VPS guides you to the General Delivery Mailbox where you can leave your message. The recorded messages will be delivered to your intended party later. Callers who do not enter anything because they are unfamiliar with the VPS can also leave messages in the same way.

► From a rotary phone, once your message has been recorded, you cannot re-record nor erase it.

- 1 Call the VPS and access the Voice Mail Service.
- 2 Wait a moment.
- 3 State **your message**.
- 4 Hang up the phone.

# Receiving External Delivery Messages

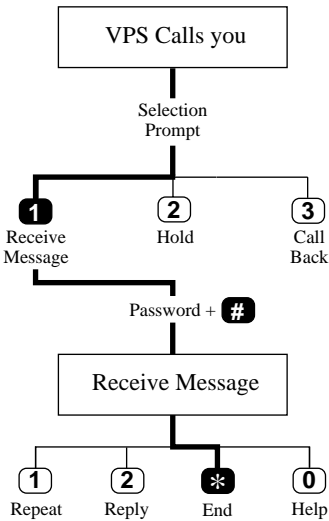

External Delivery Messages are delivered by the VPS to telephone numbers instead of mailboxes.

**1** Pick up a call from the VPS.

If the system is equipped with multiple languages (up to three languages), you will hear a selection prompt.

**2** Press **the number of the appropriate language**.

**3** Press **1** to receive the message.

**4** Enter **the password** and **#**.

• Then the VPS plays the external message.

**5** Press **\*** to end the call.

## Tip

### Step 4 —

If a password is not assigned, you can listen directly to the message.

If you enter the incorrect password three times, the VPS will play the following prompt and you cannot receive the external message any more.

*“This message is from ‘SENDER’ of ‘Company Name.’  
Please call ‘TELEPHONE NUMBER.’  
Extension number ... .  
To repeat, press [1].  
To end this call, press [\*].”*

When you press [1], the VPS will repeat this prompt.



# Replying to External Delivery Messages

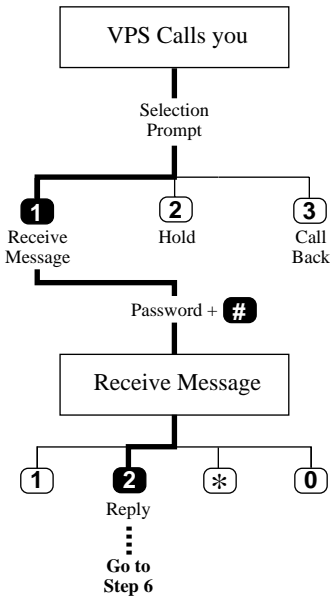

- 1-4 Same as **Receiving External Delivery Messages**.
- 5 Press **2** to reply to the message.
- 6 Record **the message** and press **1** to continue.
- 7 Press **2** to accept.
- 8 Press **1** to set this message to a private message. Otherwise, press **2**.

# Chapter 5

## Mailbox Setup

This chapter describes the setup procedures using a touch-tone telephone for subscribers.

### Contents

- Setting the Call Transfer Status  
(Call Block/Call Screening/Intercom Paging/Beeper Access)..... 5-2
- Setting up a Covering Extension ..... 5-3
- Setting the Incomplete Call Handling Status ..... 5-4
- Setting the Message Reception Mode ..... 5-6
- Recording Personal Greetings ..... 5-7
- Changing Your Password ..... 5-8
- Recording Your Name ..... 5-9
- Entry of Personal Group Distribution Lists ..... 5-10
- Recording the Names of Personal Group Distribution Lists ..... 5-11
- Deleting from Personal Group Distribution Lists ..... 5-12
- Message Waiting Lamp Notification Setting ..... 5-13
- Setting Notification by Calling ..... 5-14
- Setting Answer Lengths for the Interview Mailbox ..... 5-16
- Recording Questions for the Interview Mailbox ..... 5-17
- Erasing Questions from the Interview Mailbox ..... 5-18

# Setting the Call Transfer Status

(Call Block/Call Screening/Intercom Paging/Beeper Access)

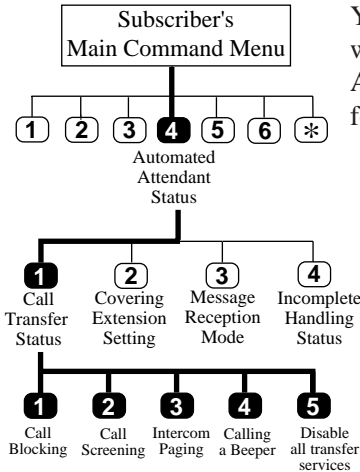

- ▶ The Intercom Paging feature is available only if your company is using a Panasonic KX-TD series telephone system.

You can specify how the VPS should handle a call when a caller specifies your extension number in the Automated Attendant Service. You can set one of the four functions or you can set none of them.

- 1 Log in **the main command menu**.
- 2 Press **4** for Automated Attendant status.
- 3 Press **1** to set the call transfer status.
  - The VPS tells you the current status.
- 4 Press the appropriate key to receive your desired option.

## 1 Call Blocking

Blocks all incoming calls to your extension.

## 2 Call Screening

Tells you the caller's name before you answer the call. Then you can decide whether or not to answer it.

## 3 Intercom Paging

Pages you over the Intercom Paging System.

## 4 Calling a Beeper

Calls your beeper and displays the caller's callback number on the LCD.

## 5 Disable all transfer services

Rings your extension directly.

# Setting up a Covering Extension

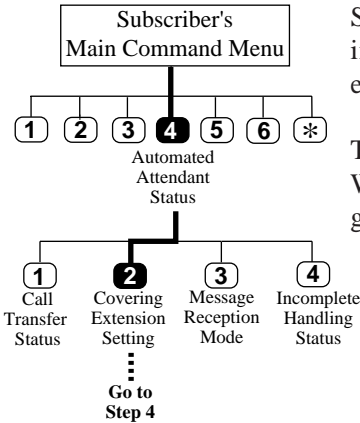

Setting up a Covering Extension lets you have incoming calls and messages transferred to a designated extension.

This extension also performs as a personal operator. When the caller presses '0' while receiving the personal greeting, the call is transferred to this extension.

**1** Log in **the main command menu**.

**2** Press **4** for Automated Attendant status.

**3** Press **2** to set up a covering extension.

**4** Press **1** to set the extension.

**5** Enter **the extension number**.

- The VPS tells you the number you have just entered.

**6** Press **2** to accept.

- ▶ The owner of this extension should be someone whom you can rely on, as he will be handling your calls when you are not available.
- ▶ This feature does not work unless Covering Extension Transfer is enabled (see page 5-4).

## Tip

### Step 4 —

You can accept the current status by pressing [2]. You can delete the current extension by pressing [3] if you don't need it.

# Setting the Incomplete Call Handling Status

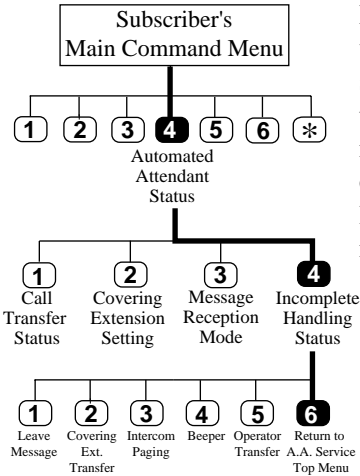

Incomplete calls are calls which are unanswered or for which the line is busy. The Incomplete Call Handling status can be set to record a message from the caller, transfer the caller to a covering extension, page the mailbox's owner by intercom, notify the mailbox's owner via beeper, transfer the caller to the operator, or let the caller try another extension. You may enable as many features as you may need among the six.

- 1 Log in the main command menu.
- 2 Press **4** for Automated Attendant status.
- 3 Press **4** to set the Incomplete Call Handling status.

## Enabling Leaving a Message Status

- 1 Press **1**.
  - The VPS tells you the current status.
- 2 Press **1** to change or **2** to accept (enable/disable).

## Enabling Covering Extension Transfer Status

- 1 Press **2**.
  - The VPS tells you the current status.
- 2 Press **1** to change or **2** to accept (enable/disable).

## Enabling Intercom Paging Status

- 1 Press **3**.
  - The VPS tells you the current status.
- 2 Press **1** to change or **2** to accept (enable/disable).

- ▶ The Intercom Paging feature is available only if your company is using a Panasonic KX-TD series telephone system.

# Setting the Incomplete Call Handling Status

---

## Enabling Beeper Access Status

**1** Press **4**.

- The VPS tells you the current status.

**2** Press **1** to change or **2** to accept (enable/disable).

## Enabling Operator Transfer Status

**1** Press **5**.

- The VPS tells you the current status.

**2** Press **1** to change or **2** to accept (enable/disable).

## Returning to Top Menu Automated Attendant Service Status

**1** Press **6**.

- The VPS tells you the current status.

**2** Press **1** to change or **2** to accept (enable/disable).

# Setting the Message Reception Mode

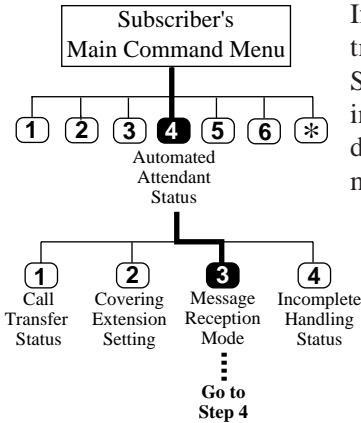

If you are not available to answer calls, those calls are treated according to the Incomplete Call Handling Status setting. When callers decide to leave messages in your mailbox, you can specify whether callers are directed to your regular mailbox or your interview mailbox.

- 1 Log in the main command menu.
- 2 Press **4** for Automated Attendant status.
- 3 Press **3** to set the message reception mode.
- 4 Press **1** to change the current setting to the other (interview mode/message recording mode).

- To use an interview mailbox, you must have the System Manager assign an interview mailbox number beforehand.

## Tip

**Step 4** —  
You can press [2] to accept the current setting.

# Recording Personal Greetings

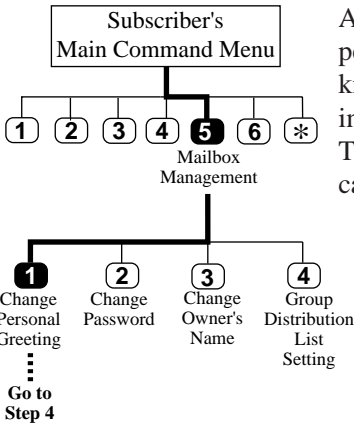

After reaching your mailbox, callers will hear your personal greeting messages first. You will record three kinds of the personal greetings: (1) No Answer Greeting, (2) Busy Greeting and (3) After Hours Greeting. The VPS plays one of them as appropriate by each call.

- 1 Log in **the main command menu**.
- 2 Press **5** for Mailbox Management.
- 3 Press **1** to record a personal greeting.
- 4 Press **1** – **3** to change the greeting.
  - The VPS tells you the current personal greeting (if it exists).
- 5 Press **1** to record a greeting.
- 6 Record **your greeting** and press **1**.
- 7 Press **2** to accept.
- 8 Confirm your setting and press **2** to accept.

## Note:

It is helpful to include a statement of your answering telephone number with the exchange name or normal code in the greeting message. A greeting message begins within 3 seconds of answering, of paytone ceasing, or of answering ceasing, as appropriate.

## Tip

### Step 4 —

- 1** No answer greeting
- 2** Busy greeting
- 3** After hours greeting

### Step 7 —

- 1** Review
- 2** Accept
- 3** Record a new one
- 4** Add
- \*** Erase and exit

### Step 8 —

You can erase the greeting by pressing [3].



# Changing Your Password

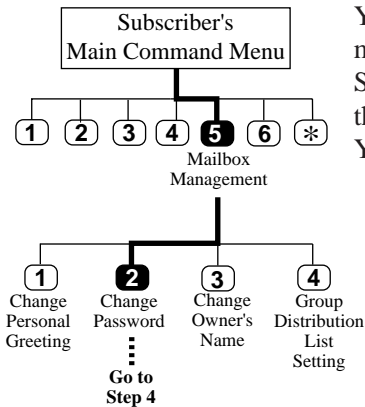

You have the option of assigning a password to your mailbox to prevent someone else accessing it to receive Subscriber's Service. A password should be no longer than eight digits and the valid keys are from '0' to '9'. You can change it at any time.

- 1 Log in **the main command menu**.
- 2 Press **5** for Mailbox Management.
- 3 Press **2** to change the password.
- 4 Press **1** to set the mailbox password.
- 5 Enter **the password** and **#**.
  - The VPS tells you the password.
- 6 Press **2** to accept.

- ▶ For your password, avoid setting it to obvious combinations of numbers.
- ▶ If you forget your password, have your System Manager delete it, then you can assign a new one.

# Recording Your Name

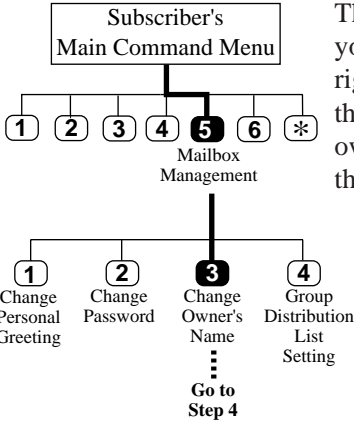

This recording is played for callers who have reached your mailbox. This assures them that they are in the right mailbox. In addition, when a caller is specifying the mailbox by entering first three or four letters of the owner's last name, the VPS will announce a series of the recorded names among which they can select.

- 1** Log in **the main command menu**.
- 2** Press **5** for Mailbox Management.
- 3** Press **3** to record the owner's name.
- 4** Press **1** to record a new one.
- 5** Record **your name** and press **1**.
  - The VPS tells you the owner's name.
- 6** Press **2** to accept.

- ▶ Record the name by which most people know you.
- ▶ If a name has been already recorded, the VPS plays the recording for you. You can then make a new recording.

## Tip

### Step 4 —

You can accept the current owner's name by pressing [2].  
You can erase the name by pressing [3].

# Entry of Personal Group Distribution Lists

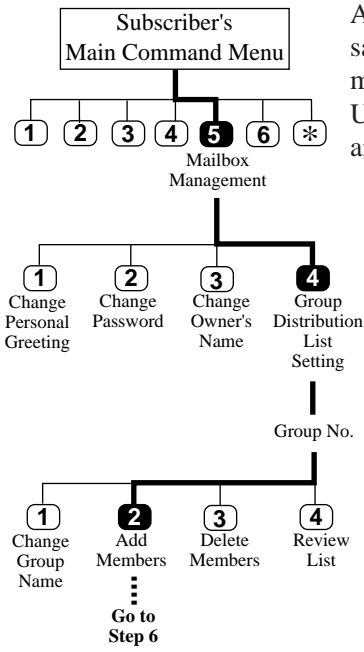

A Personal Group Distribution List is used in Message Delivery and Message Transfer to send the same message to several mailboxes with a single operation. Up to four lists can be maintained at the same time, and each list can contain up to twenty members.

- 1 Log in the main command menu.
- 2 Press **5** for Mailbox Management.
- 3 Press **4** to set the group distribution list.
- 4 Enter the group number (1 – 4).
- 5 Press **2** to add members to the list.
- 6 Enter the mailbox number to be added.
- 7 Press **2** to add the number.
- 8 Press **2** to end adding members.

Mailbox Setup

**Tip**

**Step 7** —  
You can change the number by pressing [1].  
You can end adding members by pressing [\*].

**Step 8** —  
You can continue adding members by pressing [1].

# Recording the Names of Personal Group Distribution Lists

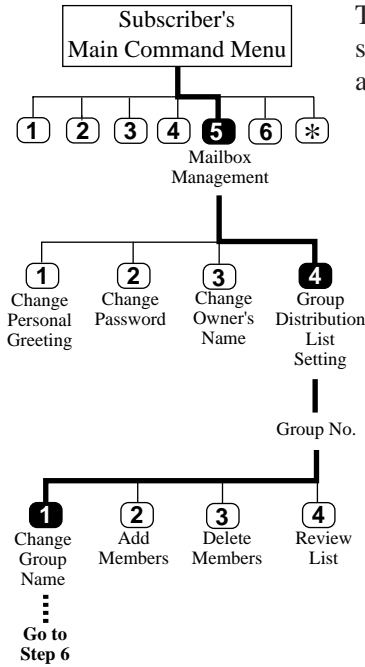

The VPS will play the recording for you when you specify a personal group distribution list. Then you assure that it is the right one.

- 1 Log in **the main command menu**.
- 2 Press **5** for Mailbox Management.
- 3 Press **4** to set the group distribution list.
- 4 Enter **the group number (1 – 4)**.
- 5 Press **1** to record the group name.
- 6 Record **the name** and press **1**.
- 7 Press **2** to accept.

## Tip

### Step 5, 6 —

If a group name is already recorded, press [1] to change this name, then record the new one.

### Step 7 —

You can erase the name by pressing [3].

# Deleting from Personal Group Distribution Lists

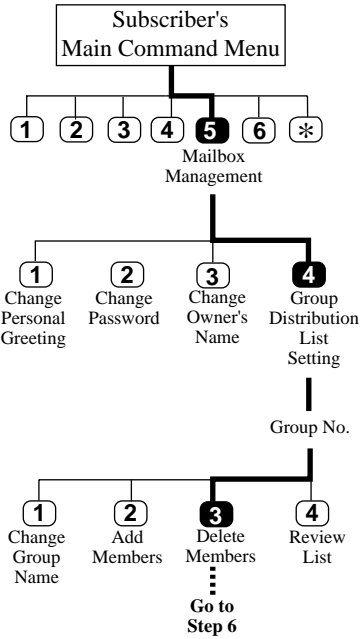

- 1 Log in the main command menu.
- 2 Press **5** for Mailbox Management.
- 3 Press **4** to set the group distribution list.
- 4 Enter the group number (1 – 4).
- 5 Press **3** to delete members from the list.
- 6 Press **2** to delete a member.
- 7 Press **1** to delete the mailbox.

Mailbox Setup

**Tip**

**Step 6** — You can delete all members by pressing [1].

**Step 7** — You can keep the mailbox and play the next mailbox by pressing [2].

# Message Waiting Lamp Notification Setting

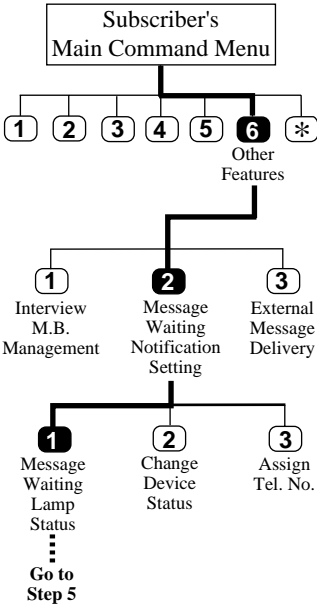

The VPS illuminates the message waiting lamp of your extension when a new message is recorded in your mailbox.

- 1 Log in **the main command menu**.
- 2 Press **6** for Other Features.
- 3 Press **2** to set Message Waiting Notification.
- 4 Press **1** to change the Message Waiting Lamp Notification Status.
- 5 Press **1** to change the Message Waiting Lamp Notification Status, or **2** to accept it.

# Setting Notification by Calling

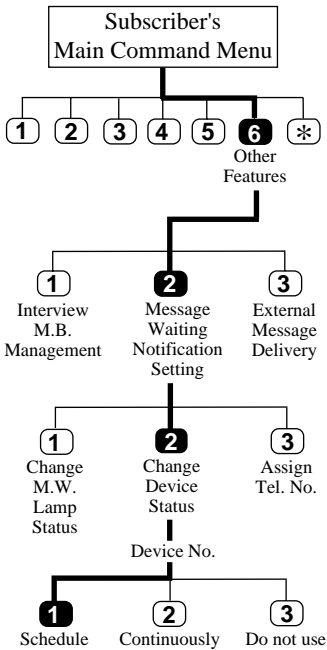

The VPS calls the preset telephone or beeper when a new message is recorded in your mailbox. Set the following three parameters as appropriate.

The VPS can notify your beeper with the callback number of the party who left the message. For this feature to work, the telephone number stored on the VPS for your beeper must include the beeper display command.

## Setting Device Status

For each device, the notification is enabled, disabled or enabled on the preset schedule.

If you want to enable it on the schedule, contact your System Administrator as you are not allowed to set the schedule by yourself.

- 1-3** Same as the **Message Waiting Lamp Status**.
- 4** Press **2** to set the device status.
- 5** Enter the **device number**.
- 6** Press **1** – **3** to select the status.

### Tip

#### Step 6 —

- 1** Schedule (enabled on the schedule)
- 2** Continuously (enabled whole day)
- 3** Do not use (disabled whole day)

# Setting Notification by Calling

- ▶ You must have your System Manager authorize the use of the Callback Number Entry Mode beforehand.

## Notification Number Assignment

You can set the telephone or beeper numbers where you wish to receive notification calls up to three. You can use the keys '0' to '9', a tone/pulse switch.

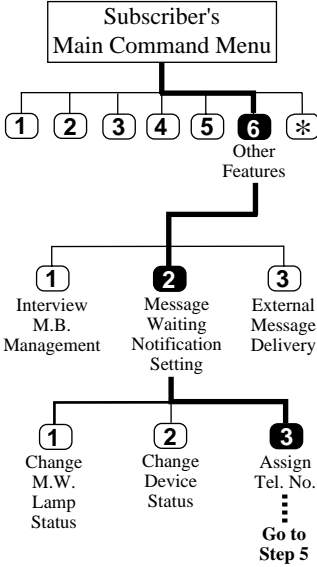

**1-3** Same as the **Message Waiting Lamp Status**.

**4** Press **3** to assign the telephone number.

**5** Press **1** to change the first telephone number, **2** to change the second telephone number, **3** to change the third telephone number.

**6** Press **1** to set the telephone number.

**7** Enter the telephone number.

**8** Press **2** to accept.

**9** Select **1** to be notified by telephone or **2** by a beeper.

### Tip

**Step 8 —**

- 1** Change the telephone number
- 2** Accept
- 3** Review
- 4** Add more digits
- 5** Insert a pause
- 6** Set dial mode
- 7** Insert a wait for dial tone
- 8** Insert a beeper display command



# Setting Answer Lengths for the Interview Mailbox

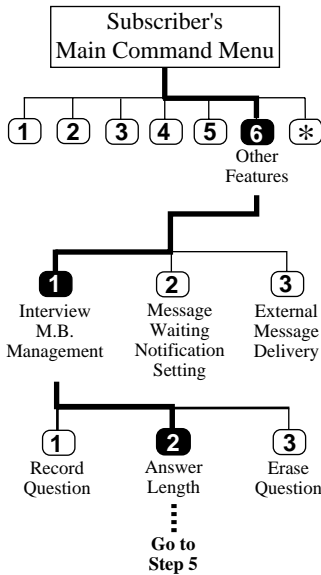

► Every Subscriber can maintain an interview mailbox. Be sure to have your System Manager assign an interview mailbox number.

An Interview Mailbox plays prerecorded questions to callers and records their answers. You can record up to ten questions and set the answer lengths from four to thirty-two seconds. The answers are recorded in a string and stored in your mailbox.

- 1 Log in **the main command menu**.
- 2 Press **6** for Other Features.
- 3 Press **1** for Interview Mailbox Management.
- 4 Press **2** to set the answer length.
  - The VPS plays the question No.1 if it has been recorded.
- 5 Press **1** to set or change the length of question No. 1.
  - The VPS plays the length if it has been set.
- 6 Press **1** to change the length.
- 7 Press **1** for 4 seconds , **2** for 8 seconds, **3** for 16 seconds or **4** for 32 seconds.
  - The VPS plays the length that you have just entered.
- 8 Accept the length by pressing **2**.
  - Then, the VPS plays the next question if it has been recorded.
- 9 Repeat steps 5 – 8.

## Tip

### Step 5 —

You can go to the next question by pressing [2] and to the previous question by pressing [3]. You can jump to the desired question by pressing [4], then the question number and [#].

# Recording Questions for the Interview Mailbox

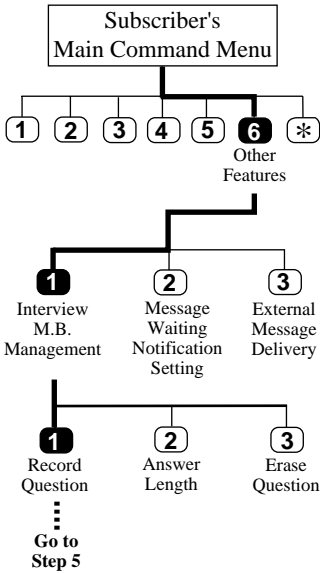

- 1 Log in the main command menu.
- 2 Press **6** for Other Features.
- 3 Press **1** for Interview Mailbox Management.
- 4 Press **1** to record questions.
  - The VPS plays the question.
- 5 Press **1** to record question No. 1.
- 6 Record the question and press **1** to end recording.
- 7 Press **2** to accept the question.
  - The VPS plays the next question.
- 8 Repeat steps 6 – 8.

## Tip

### Step 5 —

You can go to the next question by pressing [2] and to the previous question by pressing [3]. You can jump to the desired question by pressing [4], then the question number and [#].

### Step 7 —

- 1** Review
- 2** Accept
- 3** Record a new one
- 4** Add
- \*** Erase and exit

# Erasing Questions from the Interview Mailbox

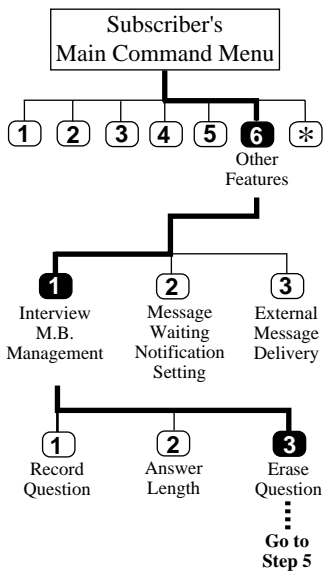

- 1 Log in the main command menu.
- 2 Press **6** for Other Features.
- 3 Press **1** for Interview Mailbox Management.
  - The VPS plays question No. 1.
- 4 Press **3** to erase the question.
  - The VPS plays the next question.
- 5 Press **1** to erase question No. 1.
  - The VPS plays the next question.
- 6 Repeat step 5.

## Tip

### Step 5 —

You can go to the next question by pressing [2] and to the previous question by pressing [3]. You can jump to the desired question by pressing [4], then the question number and [#].

\*\*\*\*\* Quick Reference \*\*\*\*\*

# Entering a Mailbox

# 1 Name

RECORD MESSAGES

Mailbox No.

\* Mailbox No.

Password #

## MAIN COMMAND

- 1 Receive message
- 2 Deliver message
- 3 Check mailbox distribution
- 4 For Automated Attendant Status
- 5 For Mailbox Management
- 6 Other features
- \* End this call

### 1 Receive

- 1 Repeat
- 1 1 Previous
- 2 Next
- 3 Erase
- 4 Reply
- 5 Rewind
- 6 Fast Forward
- 7 Transfer
- 8 Scan

(Help Menu)

### 2 Deliver

Enter the mailbox number.

- 1 Record message
- 2 Add Mailbox
- 3 Review Mailing List

### 3 Check Mailbox Distribution Status

- 1 Play the message
- 1 1 Play previous message
- 2 Play next message
- 3 Cancel

### 4 Automated Attendant Status

- 1 Set Call Transfer Status
- 2 Set Covering Extension
- 3 Set Message Reception Mode
- 4 Set Incomplete Call Handling Status

### 5 Mailbox Management

- 1 Record Personal Greetings
- 2 Set Password
- 3 Enter Owner's Name
- 4 Set Group Distribution Lists

### 6 Other Features

- 1 Set Interview Mailbox
- 2 Set Message Waiting Notification
- 3 Set External Delivery Message

**1 Call Transfer Status**

- 1 *Call Blocking*
- 2 *Call Screening*
- 3 *Intercom Paging*
- 4 *Beeper Access*
- 5 *All disable*

**4 Incomplete Call Handling Status**

- 1 *Leaving a Message*
- 2 *Covering Extension*
- 3 *Intercom Paging*
- 4 *Beeper Access*
- 5 *Operator*
- 6 *Return to A.A. Service Top Menu*

**1 Personal Greetings**

- 1 *No Answer*
- 2 *Busy*
- 3 *After Hours*

**1 Interview Mailbox Management**

- 1 *Record Question*
- 2 *Set Answer Length*
- 3 *Erase Question*

**2 Message Notification**

- 1 *Message Waiting Lamp*
- 2 *Device Status*
- 3 *Assign Telephone Numbers*

**2**

- 1 *Schedule*
- 2 *Continuously*
- 3 *Do not use*

**3 External Message Delivery**

- 1 *Record message*
- 2 *Check delivery status*
- 3 *Set a mailing list*

**Note:**

- Press **\*** at any time to exit the menu.
- Press **0** to have the Help menu.
- If you have to hang up before the prompt is finished, press **# 9**. Then hang up the phone.

**\*\*\*\* Service Access Commands \*\*\*\***

**Commands**

1	ABC 2	DEF 3
#1 Dialing by Name		#D Department Dialing
GHI 4	JKL 5	MNO 6
	#L Login	#M Voice Mail
PRS 7	TUV 8	WXY 9
#R Restart (Main Menu)	#T Transfer	#X Exit
*	0	#
* Backup		

# Memo

---

# Memo

---

**Panasonic Business Systems U.K.**

Panasonic House, Willoughby Road, Bracknell,  
Berkshire RG12 8FP

Printed in Japan

**PSQX1277ZB** KF0997CM1018