

**Electra™** The logo for 'Electra mark' features the word 'Electra' in a bold, sans-serif font with a trademark symbol. To its right, the word 'mark' is rendered in a stylized, blocky font where the letters are composed of horizontal bars of varying lengths, creating a barcode-like effect.

DIGITAL TELEPHONE SYSTEM

# INSTALLATION SERVICE MANUAL



JULY, 1987

NEC AMERICA, Inc.

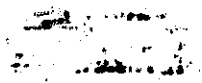

# INSTALLATION / SERVICE INTRODUCTION

This manual provides the information required to install, program, and maintain the Electra MarkII Digital Telephone System.

This manual is divided into nine chapters as follows:

## CHAPTER 1: SYSTEM DESCRIPTION

Chapter 1 contains general descriptive information about the system, and details the telephone company and FCC requirements.

It also includes feature description, terms, access codes, indications, and equipment identification.

## CHAPTER 2: HARDWARE INSTALLATION

Chapter 2 provides the information required to prepare and install the system. It also contains description and installation information about ancillary devices connected to Multiline Terminals.

## CHAPTER 3: PROGRAMMING

Chapter 3 provides descriptive information about the programming and explains how to enter the data base record onto the programming sheets (job specs) and into system memory.

## CHAPTER 4: STATION OPERATION

Chapter 4 provides the operation procedures for Multiline Terminals, Attendants, single line telephones and DSS/BLF consoles.

## CHAPTER 5: MAINTENANCE

Chapter 5 provides maintenance instructions and flow charts for the system.

## CHAPTER 6: ETI

Engineering Technical Information (ETIs) Bulletins pertinent to this system should be included in this section to provide a complete and updated field book.

## CHAPTER 7: LEAST COST ROUTING

Chapter 7 provides detailed installation and programming information for the LCR feature.

## CHAPTER 8: VOICE MAIL

Chapter 8 provides a brief outline of Voice Mail interfacing - Specific details are provided in Chapter 6, ETIs.

## CHAPTER 9: REMOTE ADMINISTRATION

Chapter 9 provides the installation, programming, and operation information for the Remote Administration Adaptor (RAA-E).

**The Electra MarkII Digital Telephone System is also the subject of the following documents:**

ND-20233 Electra MarkII Digital Telephone System General Description.

ND-20234 Electra MarkII Digital Telephone System Job Specifications (One copy supplied with each ESE-32B-1).

ND-20235 Electra MarkII Digital Telephone System Circuit Description.

ND-20236 Electra MarkII Digital Telephone System Schematic Drawings.



1997-1998  
1998-1999  
1999-2000

**CHAPTER 1**  
**SYSTEM DESCRIPTION**



# CHAPTER 1 SYSTEM DESCRIPTION

## TABLE OF CONTENTS

SECTION	DESCRIPTION	PAGE
110	GENERAL	100-1
120	REGULATORY INFORMATION	100-2
120.1	General Information	100-2
120.2	Company Notification	100-2
120.3	Incidence of Harm	100-2
120.4	Emitted Radio Frequency Interference	100-2
120.5	Hearing Aid Compatibility	100-2
120.6	Service Requirements	100-3
130	GLOSSARY OF ABBREVIATIONS	100-3
140	FEATURE DESCRIPTION	100-4
150	LCD INDICATIONS	100-16
160	FEATURE ACCESS CODES (NUMBERING PLAN)	100-19
160.1	Codes Dialed While Receiving Dial Tone or Second Dial Tone	100-19
160.2	Codes Dialed When <u>Not</u> Receiving Dial Tone or Second Dial Tone	100-21
170	EQUIPMENT IDENTIFICATION	100-22
170.1	General Information	100-23
170.2	Equipment Description	100-23

## SECTION 110 GENERAL

The Electra MarkII digital telephone system is a versatile, high performance, microprocessor based, stored program controlled, fully digital telephone system that provides numerous voice and data capabilities for handling both intra-office and outside traffic.

The Electra MarkII digital telephone system offers the flexibility required to meet almost any organization's communications needs, by using the Pulse Code Modulation (PCM) technique and time division switching.

Businesses, both small and large, can derive maximum benefit from the Electra MarkII's port oriented system design.

The Electra MarkII can provide termination for up to 80 stations and up to 40 outside lines. Systems can be tailored to a customer's needs by use of the variety of Electra MarkII's Multiline Terminals, plus standard 2500 type single line telephones.

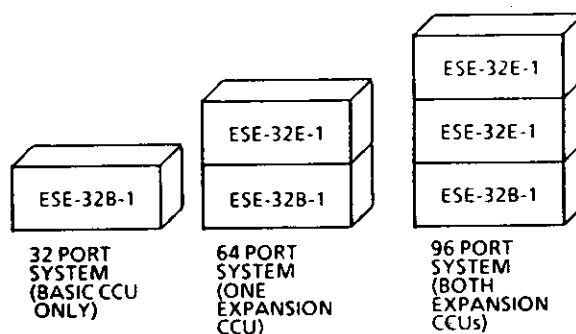

FIGURE 110-1 CENTRAL CONTROL UNITS (CCUs)

The Electra MarkII, as a total communication system, offers a wide variety of features, most of which are standard and available to all stations in the system.

The Electra MarkII is engineered for maximum user convenience and *ease of operation*. Solid state circuitry, modular construction, and a minimum of mechanical components ensure simple maintenance and high reliability.

This section of the manual provides details of the full requirements needed to be known prior to the installation of the Electra MarkII.

## SECTION 120 REGULATORY INFORMATION

### 120.1 General Information

The Federal Communications Commission (FCC) has established rules which permit this telephone system to be directly connected to the telephone network. A jack is provided by the telephone company. Jacks for this type of customer-provided equipment will not be provided on party lines or coin lines.

The telephone company may make changes in its technical operations and procedures. If such changes affect the compatibility or use of this telephone system, the telephone company is required to give adequate notice of the changes.

### 120.2 Company Notification

Before connecting, or disconnecting, this telephone system to, or from, the telephone network, the telephone company must be provided with the following:

1. Your telephone number.
2. FCC registration number:
  - a. If the Electra MarkII is to be installed as a Multifunction System, the registration number to be provided to the local telephone company is:  
AY589N-16156-MF-E
  - b. If the Electra MarkII is to be installed as a key system, the registration number to be provided to the local telephone company is:

AY589N-16174-KF-E

To install the Electra MarkII as a key system, the system cannot contain any SLI-E( ) ETUs with dial

access to the Trunk Groups. The Trunk Group Access Code Group Assignment must be programmed to make vacant all Access Code Group Assignments, and the system must be equipped with a CPU-EB ETU.

3. Ringer equivalence number: 2.0B
4. USOC Jack required:  
RJ21X for 50 position miniature ribbon amphenol type connector.

*Items 2 and 3 mentioned above, are also indicated on the system equipment label.*

### 120.3 Incidence of Harm

If this system is malfunctioning, it may also be causing harm to the telephone network. The telephone system should be disconnected until the source of the problem can be determined and until repair has been made. If this is not done, the telephone company may temporarily disconnect service.

### 120.4 Emitted Radio Frequency Interference

In compliance with FCC Part 15 rules, the following statement is provided:

#### IMPORTANT NOTE:

*"This equipment generates, uses, and can radiate radio frequency energy and if not installed and used in accordance with the installation service manual, may cause interference to radio communications. This equipment has been tested and approved for compliance with the limits for a Class A computing device pursuant to Subpart J of Part 15 of FCC Rules, which are designed to provide reasonable protection against such interference when operated in a commercial environment. Operation of this telephone system in a residential area, is likely to cause interference, in which case the user, at his or her own expense, will be required to take whatever measures may be required to correct the interference."*

### 120.5 Hearing Aid Compatibility

The Multiline Terminals provided for this telephone system are NOT hearing aid compatible. FCC rules prohibit the use of nonhearing aid compatible telephones in the following locations:

1. Any public or semi-public location where coin operated or credit card telephones may be found.



2. Elevators, highways, and tunnels (automobile, subway, railroad or pedestrian) where a person with impaired hearing might be isolated in an emergency.

3. Places where telephones are specifically installed to alert emergency authorities such as fire, police or medical assistance personnel.

4. Hospital rooms, residential health care facilities, convalescent homes, and prisons, specifically where telephones are used for signaling life threatening or emergency situations if alternative signaling methods are not available.

5. Workstations for hearing impaired personnel.

6. Hotel, motel, apartment lobbies; in stores where telephones are used by patrons to order merchandise; in public transportation terminals where telephones are used to call taxis, or to reserve lodging or rental automobiles.

7. Hotel and motel rooms. At least ten percent of the rooms must contain hearing aid compatible telephones; or contain jacks for plug in hearing aid compatible telephones which will be provided to hearing impaired customers upon request.

Single line telephone sets used in conjunction with this telephone system may or may not be hearing aid compatible. The manufacturer of the single line telephone set must provide notice of hearing aid compatibility to comply with FCC rules. The Multiline Terminals provided for this telephone system can be made hearing aid compatible.

**120.6 Service Requirements**

In the event of equipment malfunction, all repairs will be performed by NEC or an authorized agent of NEC. It is the responsibility of users requiring service to report the need for service to NEC or to one of their authorized agents.

**SECTION 130  
 GLOSSARY OF ABBREVIATIONS**

**-A-**

**ADA** Ancillary Device Adapter  
**ANS** Answer Key

**ATT** Attendant  
**-B-**

**BGM** Background Music

**BLF** Busy Lamp Field  
**-C-**

**CCU** Central Control Unit

**CNF** Conference Card (feature and control button as well)

**CPU** Central Processing Unit

**CO** Central Office

**COI** Central Office Line Interface  
**-D-**

**DID** Direct Inward Dialing

**DIR** Directory Key

**DND** Do Not Disturb

**DP** Dial Pulse

**DPA** Dual Path Adapter

**DSS** Direct Station Selection (also DSS/BLF)

**DTA** Data Terminal Adaptor

**DTMF** Dual Tone Multi Frequency  
**-E-**

**ECR** External Control Relay Card

**ESI** Electronic Station Interference

**ETE** Electronic Telephone Equipment

**ETU** Electronic Telephone Unit

**EXT** Extension  
**-F-**

**FCC** Federal Communications Commission

**FWD** Forward

**FWD/ BNA** Forward Busy/No Answer

**-G - H -**

**HFU** Handsfree Unit (Speakerphone)

**-I-**

**IC** Integrated Circuit  
**IDF** Intermediary Distribution Frame  
**INT** Internal (Calling on Intercom)

**-J - K - L-**

**LCD** Liquid Crystal Display  
**LCR** Least Cost Routing  
**LED** Light Emitting Diode  
**LK** Line Key

**-M-**

**MDF** Main Distribution Frame  
**MFR** Multi Frequency Receiver (Dual Tone)  
**MIC** Microphone (Unit and Control Button)  
**MMC** Module Memory and Controller  
**MSG** Message  
**MW** Message Waiting

**-N-**

**NBR** Number

**-O-**

**OCC** Other Common Carriers  
**OPX** Off-Premises Extension

**-P-**

**PCM** Pulse Code Modulation  
**PE** Primary Extension  
**PSU** Power Supply Unit  
**PT** Power Failure Transfer, Tip Side  
**PR** Power Failure Transfer, Ring Side

**-Q - R-**

**RAA** Remote Administration Adaptor  
**RSG** Ringing Supply Generator

**-S-**

**SCC** Specialized Common Carriers

**SE** Secondary Extension  
**S&R** Save and Repeat (Feature and Control Button)  
**SLI** Single Line Telephone Interface  
**SLT** Single Line Telephone  
**SMDR** Station Message Detail Recorder  
**SPD** Speed Dial  
**SPKR** Speaker (Control Button)  
**STA** Station

**-T-**

**TDM** Time Division Multiplexing (Switching Method)  
**TLI** Tie Line Interface  
**TRF** Transfer (Feature and Control Button)  
**TSW** Time Division Switch

**U - V-**

**VMI** Voice Mail Interface

**-W-**

**WMU** Wall Mount Unit Station

**SECTION 140  
 FEATURE DESCRIPTION**

**ACCOUNT CODE ENTRY** allows the recording of up to 14 digits, when on an outside call. This feature requires the use of the SMDR-E ETU and becomes a part of the generated call records.

**ADD ON CONFERENCE** provides the ability to converse with up to three additional parties, in any combination of internal and / or outside, however, not more than two outside lines can be included. This feature can be accomplished with the use of a CNF-E ETU which can be installed in any available interface slot (*up to a maximum of four CNF-E ETUs per system*). Conference calls are not amplified and are therefore subject to the quality of the CO lines used.

**ALL CALL PAGE** - All stations, not restricted from access to paging, are able to initiate a voice page to all idle Multiline Terminals speakers. Any station can respond to the page call, releasing the paging and establishing a private conversation. This feature is

software controlled and can be disabled, if desired.

**ALPHANUMERIC DISPLAY;** two of the four Electra MarkII Multiline Terminals are provided with a two line LCD; each of the two lines are capable of showing up to 16 digits, with more than fifty different fixed and flexible readouts. These Multiline Terminals are the ETE-6D-1 and ETE-16D-1

L	K	1	2		N	E	I	L	A			2	0	9
0	7	:	4	3		S	E	P	0	2		M	O	N

Figure 140-1 Two Line Liquid Crystal Display

The ETE-6-1 does not have a display; the ETE-16K-1 Multiline Terminal is equipped with a 7 line LCD; each line capable of showing 16 digits. The top two lines of the LCD are equivalent to that of the ETE-6D-1 and ETE-16D-1 Multiline Terminals. The bottom five lines provide a directory function with eleven pages individually customized by the Multiline Terminal user - each page can contain up to ten commonly called numbers (*Speed Dial*). Each Electra MarkII system can accommodate a maximum of thirty (30) ETE-16K-1 Multiline Terminals.

**ANCILLARY DEVICE CONNECTION** - The Electra MarkII Multiline Terminals have the ability to support the additional operation of either a headset jack, automatic dialer, handset amplifier or external speakerphones. This is made possible with the addition of an ADA-E unit to the Multiline Terminal.

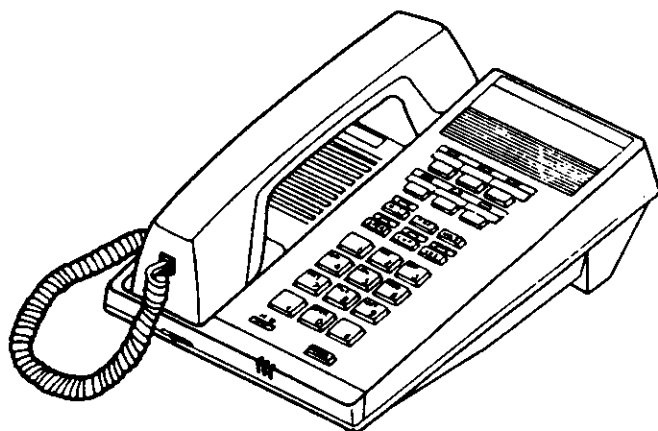

Figure 140-2 ETE-6-1 Multiline Terminal

**ANSWER HOLD** provides the ability to place an on-going call on hold by depressing the *Answer Key*, to respond to an incoming call.

**ANSWER KEY** is provided on all Multiline Terminals. The LED associated with the *Answer Key* flashes when an internal call is directed to that Multiline Terminal's extension, and when any line key is ringing at that station. Additionally, the *Answer Key's* LED will flash when that station receives a *Camp-On* or *Tone Override* signal. By depressing the *Answer Key*, the Multiline Terminal user places any current call on HOLD and answers the incoming or recalling CO call, *Camp-On*, or *Override*.

**ATTENDANT CAMP-ON;** with a Direct Station Selection/Busy Lamp Field (DSS/BLF) console, allows the attendant to expeditiously process calls even to busy extensions. If, after a preprogrammed time period, the *Camp-On* remains unanswered, the call will recall to the attendant.

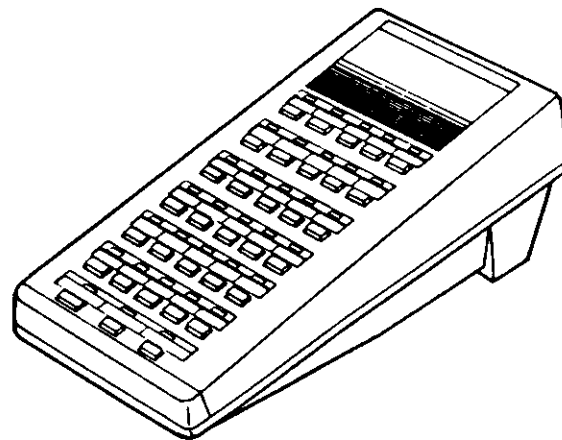

Figure 140-3 EDE-30-1 (DSS/BLF) Direct Station Selection/Busy Lamp Field or CO Add-On Module

**ATTENDANT POSITIONS** possible within the Electra MarkII system are a maximum of four. When programmed as an attendant terminal, the standard ETE-16D-1 Multiline Terminal has special access to features only available to an attendant. Some of these attendant features are programming and displaying *System Speed Dial* memories, setting *Night Mode*, setting up calendar/clock, busy out defective trunks and MFR ports, use of one or two DSS/BLFs and a CO Add-On module, and more.

**ATTENDANT TRANSFER** can be made quickly by use of the Direct Station/Busy Lamp Field consoles. Any attendant may *Camp-On* or *Transfer* calls to extensions that appear on one of the DSS keys of the DSS/BLF console. The transfers may be supervised (voice announced with answer) or unsupervised (ringing before answer). Unanswered attendant transfers recall to the attendant position, accompanied with a display identifying both the line key being recalled and the extension the transfer or camp-on was made to.

**AUTOMATIC CALLBACK** allows users to prompt the system to notify them when a busy extension becomes available. After calling a busy extension, set an *Automatic Callback* by dialing \*1 (as set in default). When both parties are idle, the system will signal, first, the originator and, after answer, the called station.

**AUTOMATIC HOLD** occurs whenever an attendant, with a DSS/BLF console (engaged in a call), depresses a DSS extension or paging access button. This places the call on *NON-EXCLUSIVE HOLD*. This is also true for Multiline Terminal users that have programmed, and depress the **Feature Access** keys for DSS or paging access. This places the call on *Consultation Hold*.

**AUTOMATIC RELEASE** is performed by the Electra MarkII System when an outside party abandons the call (*for this feature to function the outside line must provide a timed disconnect signal*). Automatic release is always provided with ground start trunks and E&M Tie lines.

**BACKGROUND MUSIC** via **EXTERNAL SPEAKERS**, used for paging from the Electra MarkII system, will be interrupted only to those speakers paged (within a zone). This feature requires a locally supplied music source, paging system and control relay as well as the optional ECR-E ETU.

**BACKGROUND MUSIC** can be provided to all Multiline Terminal users. The system is designed to accept two separate music sources to be utilized. Each user can select either music source to be heard over their Multiline Terminal's speaker.

**BATTERY BACKUP** of system memory is provided via small batteries on selected printed circuit boards to protect such memories as the system program,

*Speed Dial*, messages and *Clock/Calendar*, *SMDR*, *LCR*, to list just a few.

**BROKER'S CALL** is a calling method offered to allow a station user to alternate between two calls. Multiline Terminal users merely depress the *Answer Key* to alternate between two calls on the same line key. Single line telephone users depress the **hook flash** and dial the access code ( set in system default as 4#).

**BUSY LAMP FIELD** telephone is a standard programmable feature of the ETE-16D-1 Multiline Terminal. Any of the twenty programmable **Feature Access** keys which are programmed for Direct Station Selection, will also provide Busy Lamp Field indication, of the station or virtual extension programmed. A maximum of ten ETE-16D-1 (with BLF assigned) Multiline Terminals can be connected to each Central Control Unit (CCU).

**CALCULATOR FUNCTION** is offered to all Multiline Terminals with an LCD. This is a four function six digit calculator which can be accessed by up to five stations simultaneously.

**CALLBACK MESSAGE** is an indication on the terminal's LCD of who within the system has called and would like a return call. Up to five *Callback Messages* can be received at any station. The LCD indicates the amount of *Callback Messages* (to a maximum of five, including *Message Waiting* from an attendant and from the voice mail). The messages can be scanned one at a time. Each message display gives the time the message was left, identifies the caller, and provides a number to call. *Callback Messages* can be cleared while the terminal is idle, or will be automatically removed when the call is returned.

**CALL FORWARD - ALL CALLS** allows a station user to re-direct all calls to their extension to someone else's extension, a virtual extension, or an *Attendant Position*. The ability to set *Call Forward* is a function of the stations *Class of Service* assignment. *Call Forward All Calls* can be set or cancelled by the forwarding station, by the destination station, or by the attendant.

**CALL FORWARD - BUSY/NO ANSWER** allows a station user to re-direct all calls to their extension, while they are talking on it or while they are away

from their station, to someone else's extension, a virtual extension, or an attendant. The ability to set *Call Forward* is a function of the stations *Class of Service* assignment. *Call Forward-Busy/No Answer* can be set or cancelled by the forwarding station, by the destination station, or by the attendant.

**CALL PARK** allows a station user to temporarily park any call (except a four party conference, or a *Conference* made on two line keys); removing the call from the extension placing it on hold thereby, allowing the extension to be free for other call processing functions. The call can be retrieved at any station within the system by dialing an access code (4\*X as set in default where X is a call park location 0~9) and the *Call Park* area used. A parked call will recall to the primary extension of the station that placed the call. The system, when equipped with a CPU-EB ETU, will provide ten *Call Park* areas.

**CALL PICKUP-DIRECTED** provides any station the capability to answer a call (voice or ringing) intended for a different station, by dialing an access code.

**CALL PICKUP-GROUP** provides the ability to assign station pickup groups to enable ringing calls in the group to be answered by any station within the group by dialing an access code. The system provides eight *Call Pickup Groups*.

**CALL TRANSFER** can be performed by any station in the system, of any call, to any other station in the system. The ability to originate or receive *Camp-On* (a form of *Transfer* to busy extensions) is based on the *Class of Service* assignment of both stations.

**CLASS OF SERVICE** is a programming assignment to allow or deny access to *Camp-On Originate/Receive*, *Call Forward*, *Operator Restriction*, *Data Line Security*, *Station Lockout*, *Data Access (Originate)*, and LCR priority features. *Incoming*, *Outgoing* and *Code Restrictions* are assigned separately.

**A CLOCK/CALENDAR DISPLAY** is provided to all Electra MarkII Multiline Terminals with an LCD. This display is on the bottom line of the LCD; ie: displays the time of day, 07:43, the month, SEP., the date, 04, and the day, SUN. This display is only removed during off line programming mode, when the *Calculator* mode is in use, or during certain data communication operations.

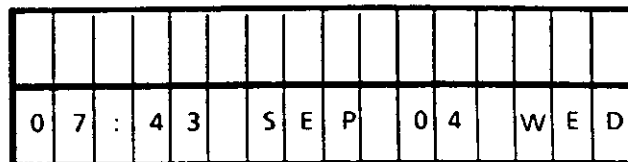

Figure 140-4 Typical Clock Calendar Display

**CO ADD-ON MODULE.** The EDE-30-1, Revision B or higher, can be installed and programmed as a **CO ADD-ON MODULE** to allow an *Attendant Position* the ability of having direct access to the system's forty maximum outside line terminations. The system's maximum of six EDE-30-1 applies to both applications; only four units can be utilized as a *CO Add-On Module* (one per *Attendant Position*). The system must also be equipped with a CPU-EB ETU.

**CODE RESTRICTION** aids in the ability to tailor the station dialing restriction to every customer's individual needs. The Electra MarkII offers an advanced network of restrictions to control outside calls, based upon area and local office codes. The restriction feature provides override capability on a trunk group basis and accommodates *Equal Access* to secondary common carriers.

**CONSECUTIVE SPEED DIAL** simplifies dialing complicated sequences of numbers such as those used for some specialized common carriers, credit card, and other applications. All Electra MarkII Multiline Terminals have the capability to *Consecutively Speed Dial*, with access to *System* and *Station Speed Dial* memories.

**CONSULTATION HOLD** offers the Electra MarkII system user the convenience of originating a call to a second station in the system while using the same line from an existing call. This allows the user to consult with someone while holding the outside party. Afterwards the user may initiate a *Conference*, return to the outside party, alternate between the two calls (*Broker's Call*), or *Transfer* the outside party to the consulted internal party.

**DATA COMMUNICATION** is made available when the system is equipped with a CPU-EB ETU and with a DTA-E unit installed in each Multiline Terminal (ETE-6D-1, ETE-16D-1 and ETE-16K-1) requiring this feature. These data ready Multiline Terminals require ESI-EB type ports. The DTA-E unit provides a terminal user with the capability of *Data Communication* and *Voice Communication* simultaneously.

**DATA LINE SECURITY** provides a station protection from receiving audible tones (such as *Camp-On* or *Override*) while busy; this prevents disruption of ongoing data transmission when a terminal is connected to an acoustic coupled modem.

**DC POWER OPERATION** may be desired for its simplicity of providing standby power. The system can be powered by a local -48VDC source. When so required, each CCU must be equipped with a PSE-DD-1 PSU; this PSU is installed instead of the PSE-AD-1 PSU.

**DIAL 0 FOR ATTENDANT** speeds the calling process when seeking to reach the attendant. When the system is configured with more than one attendant position **DIAL 0** will enable the user to reach the attendant assigned.

**DIRECT INWARD DIALING (DID)** allows outside calls on DID trunk to be directed to particular stations within the system. These terminations can be accommodated when the system is equipped with TLI-E ETUs and a CPU-EB ETU. A maximum of forty such terminations of line terminations can be accommodated in each system; this total including Tie lines and CO lines. DID signaling supports immediate, delayed, and wink start.

**DIRECT PAGING ACCESS** with the EDE-30-1 DSS/BLF console provides the attendant added speed in call processing and locating personnel. Buttons can be programmed to provide direct access to *All Call Paging*, *Internal*, or *External Zone Paging*. The programmable **Feature Access** keys on the Electra MarkII Multiline Terminals can also be used for direct paging access.

**DIRECT STATION SELECTION** provides one button selection to rapidly call internal parties. DSS/BLF consoles and the programmable function buttons on the Electra MarkII Multiline Terminals provide this operation.

The **DIRECTORY FUNCTION** of the ETE-16K-1 Multiline Terminal provides the station user with an eleven page LCD, customized by the user. Each page can contain up to ten frequently called numbers. Depressing the directory button causes the pages to change; depressing one of the selection buttons generates a speed dial call, DSS call, or accesses a feature (depending upon the user's programmed

preference). A maximum of thirty ETE-16K-1 Multiline Terminals can be installed in a system.

**DISTINCTIVE RINGING** allows a user to distinguish between outside, internal, and *Boss/Secretary Ring* signals. Each Electra MarkII Multiline Terminal has a further choice in selecting between two ringing tones. This selection can be done by user programming at each Multiline Terminal or at the attendant.

**DO NOT DISTURB** provides the Multiline Terminal user with the ability to temporarily eliminate all audible signals, for incoming calls to that station except calls from an attendant and *Boss/Secretary Ring*.

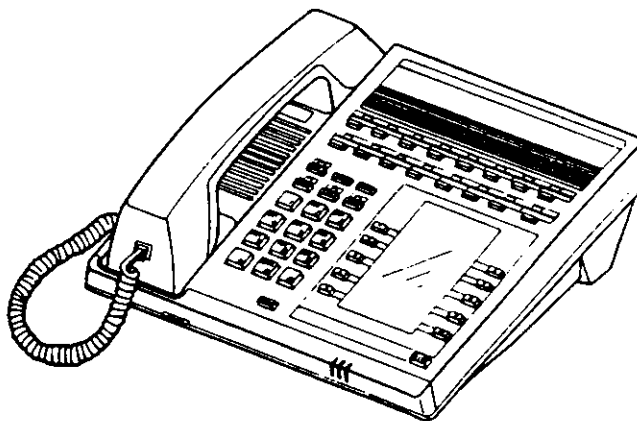

Figure 140-5 ETE-16K-1 Multiline Terminal

The **DSS/BLF CONSOLE** is a unit that provides thirty programmable buttons, each with a two color (red and green) LED, for use with an ETE-16D-1 Multiline Terminal. Together, the console and Multiline Terminal create an *Attendant Position*. The console provides the attendant with single button access to any assigned extension, page zone or system feature. When a button is assigned for direct station selection, the associated RED LED provides the attendant with Busy Lamp Status of the assigned station. The associated GREEN LED provides the attendant with the busy status of the assigned station, indicating when the attendant can reach it by means of *Override*, or *Camp-On*. The associated GREEN LED also provides the attendant with the status of messages left for busy or unattended stations, when in the message mode.

Up to two *DSS/BLF Consoles* can be set to function with an *Attendant Position*; up to two attendant

positions can be provided with two *DSS/BLF Consoles* each, two more *Attendant Positions* can each be equipped with one *DSS/BLF Console*. The resulting totals are six *DSS/BLF Consoles* associated with four attendant positions. The number of *CO Add-On Modules* will also affect the 6 console maximum.

**DSS/BLF RECALL** with station identification provides the originating attendants' LCD with the line key number that was transferred or camped on, as well as, the station number of the station that did not answer the *Camp-On*. This allows the attendant to respond and address the recall quickly and efficiently.

The **ELAPSED CALL TIMER** is a counter which is shown on the LCD of a Multiline Terminal engaged in an outside call. This timer provides a constant reminder of the on going call's length.

E	L	A	P	S	E	D				0	1	:	4	5
1	2	:	2	5	S	E	P	1	6	T	U	E		

Figure 140-6 LCD with elapsed call time.

**EQUAL ACCESS ACCOMMODATION** is provided to permit the *Speed Dial* memories and *Code Restriction* processes to allow connection of CO lines that provide access to *Specialized Common Carriers (SCC)*.

**EXTERNAL ZONE PAGING (WITH MEET ME)** enables system users to quickly, and easily, locate and communicate with each other. The system provides for the ability to set up three zones (plus all zones) of *External Paging* with the optional *ECR-E ETU* (and locally provided amplifier, speakers and relays). With the page Meet-Me feature, the Electra MarkII system allows any station in the system the ability to answer a page, at which time the paging circuit is released and is again available for paging.

The Electra MarkII provides a common uninterrupted signal to the optional *ECR-E ETU* for **External Tone Ringing**. The *ECR-E ETU* contains five control ring relays, each relay can be programmed for a different interruption pattern. When connected to a locally provided call alerting device, this feature provides a user in a noisy environment the ability to hear an incoming outside line ringing.

**FLEXIBLE LINE ASSIGNMENT** provides the ability to assign any (except for each Multiline Terminal's own extension) line keys to outside lines, appearances of other extension lines, *Save and Repeat*, *Data Transmit*, *Data Receive*, and *Do Not Disturb* features.

Electra MarkII's **FLEXIBLE NUMBERING PLAN** is assigned by the resident system program when the system is first initialized. With a few exceptions the numbering plan can be altered for customer requirements, via system programming.

**FLEXIBLE RINGING ASSIGNMENT** is the ability to provide ring tone signals to stations that have an appearance of the CO or extension line being called. Separate ringing assignments can be set for *DAY MODE* and *NIGHT MODE*.

**FLEXIBLE TIMEOUTS** are provided to allow the system to be altered, via programming, to meet the customer's needs. Standard timeouts are set by the resident system program upon first initialization.

**FULL HANDSFREE OPERATION** is an optional feature that can be accomplished in either of two methods: installation of the *HFU-E* unit into the Multiline Terminal or installation of the *ADA-E* unit into a Multiline Terminal with a qualified speakerphone (locally provided) connected. Either method allows a Multiline Terminal user to initiate or receive a call (outside or internal) and converse without using the Multiline Terminal handset.

**GROUND START TRUNKS** minimize the possibility of incoming and outgoing calls colliding on the same *COI-E ETU*. This phenomenon (collision) is known as **glare**. In addition, automatic release is always provided on ground start trunks.

**HANDSFREE ANSWERBACK** is a convenience feature that allows a Multiline Terminal user to respond to a voice call without lifting the handset. When a voice call is received, at a Multiline Terminal, the voice is heard from the Multiline Terminal's speaker and the user can respond handsfree, via the Multiline Terminal's microphone, provided the microphone is on (*ON/OFF* status is indicated by the red LED above the MIC button).

**HANDSFREE DIALING AND MONITORING** allows a Multiline Terminal user to initiate a call and monitor the line without lifting the handset.

**HOLD (EXCLUSIVE AND NON-EXCLUSIVE)** with **RECALL** are features provided to allow for individualized and speedy call handling.

**EXCLUSIVE HOLD** allows a station user to place an ongoing conversation on **HOLD** while ensuring that no other stations are able to accidentally remove it from hold. The holding station's corresponding line key LED (green) provides a special interrupted wink I-HOLD indication, (ETE-6-1, LED is red) for easy identification; all other stations with that appearance have the corresponding LED (red) lit steadily. (Single line telephones do not have hold indication).

**NON-EXCLUSIVE HOLD** enables a Multiline Terminal user to place an ongoing conversation on **HOLD** and allows the user to go to any other station, with that appearance, and retrieve the call from hold. The LED indication of the held line is shown as green (ETE-6-1 is red) **wink** at the holding station (or interrupted I-HOLD wink) and **red wink** at all the other stations. (Single line telephones do not have this ability).

**HOLD RECALL** provides a reminder to the user that has forgotten a call placed on hold; this recall is provided for either *Exclusive* or *Non-Exclusive Hold*. The **RECALL** to a station is controlled by a timer that is preprogrammed by the installer.

The LED, at the holding station will flutter green (the ETE-6-1 LED is red), while at other stations it will remain steadily lit or **winking red**. Accompanied, at the holding station, with the change in the LED flash rate is an audible **RECALL TONE**, a 1024 Hz tone provided at a duty cycle of 60 IPM.

**I-HOLD INDICATION** shows a Multiline Terminal user which lines on hold are being held by that Multiline Terminal. A green LED indication is provided (the ETE-6-1 is red) at the rate of a **burst wink**, all other stations with that appearance see a red LED at the rate of a **wink**, or steadily lit.

**I-USE INDICATION** shows a Multiline Terminal user which line the user is conversing on. The indication provided is a green (ETE-6-1 is red) LED steadily lit. All other stations with that appearance see a red LED steadily lit.

**INCOMING CALL IDENTIFICATION** allows all LCD equipped Multiline Terminals to quickly know who, internally, is calling. This is provided on the

TOP line of the LCD, showing the callers name and extension number. Calls from outside lines generate a display of the line key number and the type of call (i.e. incoming or transfer, etc.). When a call comes in on the **PE** the LCD shows who's calling; if the call comes in on an **SE**, the user must depress the line key (while on hook) to see the name and number of the caller.

L	K	1	2		N	E	I	L		A			2	0	9
1	0	:	0	5		S	E	P		1	7		W	E	D

Figure. 140-7 LCD Call Display (Internal Call)

**INTERNAL VOICE/TONE SIGNALING** flexibility enables a Multiline Terminal user to select the method he wishes to be signaled with, by other station users. The caller has the added flexibility to tone ring a station that has been set for voice calling by dialing an additional digit.

**INTERNAL ZONE PAGING (WITH MEET-ME)** allows anyone (if allowed by *Class of Service*) within the Electra MarkII system to generate a voice page, via station speakers, to selected or to all zones of the installation. Up to three zones can be established by program assignment of stations into particular zones. Any station can release the page and talk privately to the originator of the page call by dialing the Meet-Me answer access code (set by default as 556).

**LAST NUMBER REDIAL** allows a station user to redial the last outside number they dialed, either from the dial key pad, *Save and Repeat* key button, or *Speed Dial* key button. This feature is accessed by dial code (dial \*) or programmable **Feature Access** key.

**LEAST COST ROUTING** (dial access to a CO line), processes the completion of an outside call via the least costly route available. The LCR-E ETU provides cost effective call routing based on the time of day and day of week.

**LOOP START TRUNKS** can be terminated onto the Electra MarkII's MDF via the telephone company provided RJ21X terminal. System assignment of trunk type (*Loop Start* or *Ground Start*) is done on a per trunk basis, at the associated COI-E ETU.

**MESSAGE WAITING** indication is provided to all stations within the system (except single line



telephones without a *Message Waiting* lamp or not supported by an SLI-EB ETU). The ETE-6-1 will show a lit red LED marked MW, each of the other type Multiline Terminals will display MSG and the quantity of messages, requests for *Call Backs*, and *Voice Mail Messages* sent to that station (up to a maximum of 5). Multiline Terminals with LCD have the ability to select which message to respond to first, by scrolling (*on-hook, dial digit 1 to scroll from message 1 to 5*) the messages. The message displayed shows the time the message was left, the name of the person who left the message and the extension number of the station from which the caller left the message. To return the call, the station user dials the number indicated. Once dialed, the *Message Waiting* indicator changes; i.e. LCD may have shown MSG3, after call to the calling station, LED shows MSG2. The red LED (MW) on the ETE-6-1 is extinguished by the setting attendant when all messages are cleared.

**NOTE:** Attendant manually resets the *Message Waiting* indication on the *DSS/BLF Console*.

**MICROPHONE CONTROL** is provided to all Multiline Terminal users to allow muting of the station's microphone. This ensures privacy during an incoming *Voice Announcement* or during a *Handsfree* conversation (if equipped with the HFU-E Unit).

**MODEM POOLING** allows the system user access to external switching of data; it supports asynchronous, half or full duplex calls at 300 or 1200 bps via the outside network.

Each of the modems (four maximum) must be 212A compatible, provide auto answer, and must be supported by an SLI-E( ) ETU port, a Multiline Terminal with LCD (equipped with a DTA-E unit) and supported by an ESI-EB ETU port. The system must also be equipped with a CPU-EB ETU and an RSG-E unit.

**MULTIPLE TRUNK GROUPS** allow custom fitting of the Electra MarkII's trunks to meet almost any customer's needs. The system provides for the programming ability to assign up to 40 trunks into a maximum of eight trunk groups. Each trunk group can be assigned a separate access dial code, or can share the same dial access code.

**MUSIC ON HOLD** connects a locally provided music source to an outside party whenever a call is placed on any type of HOLD. MUSIC ON HOLD can also be

provided via the music chip on the TSW-E ETU. This chip offers two different musical selections.

**NIGHT CALL PICKUP** functions when the system is placed in *Night Mode* by the attendant. In the *Night Mode*, stations are able to answer incoming outside calls by dialing the *Night Call Pickup* access code (set by default as 60), or by depressing a programmed function button. Tenant assignment and incoming restriction programming affect which calls can be answered.

When the system is equipped with an ECR-E ETU, it is capable of providing up to three distinct **NIGHT CHIMES**, when in the *Night Mode*. The ECR-E ETU contains three relays that can be programmed to provide closures during incoming outside line ringing. In *Tenant* systems, each tenant has its own *Night Chime* relay.

**NIGHT TRANSFER** is a function controlled only by the *Attendant Positions* (with or without *DSS/BLF Consoles*). When an attendant sets the system into *Night Mode*, it provides a change (if so programmed) from the *Day Mode* ringing assignment and enables the *Night Call Pickup* feature.

**OFF-HOOK VOICE ANNOUNCEMENT** can be provided to any Multiline Terminal (except ETE-6-1) with the installation of the DPA-E unit. The DPA-E unit provides a Multiline Terminal with a secondary voice path which allows that station to receive a *Voice Announcement* while on a handset call with someone else. This also requires the Multiline Terminal to be supported by an ESI-EB ETU, as well as being programmed as a *Dual Path* terminal.

**OFF-HOOK RINGING** allows a Multiline Terminal user to hear when an incoming call is signaling, while the Multiline Terminal handset is in use. The off-hook ring is provided at a reduced level. This can also be disabled if the user does not want this capability.

**OFF-PREMISES EXTENSION** is one of the features which expanded the Electra MarkII system beyond the ranges normally provided in a system of this size. This feature allows the connection of a standard (DTMF) single line telephone, located remotely from the main installation site, to access the system's features with the same capabilities as an on premises single line telephone. Locally provided DLI equipment is required for this feature.

**POWER FAILURE TRANSFER** ensures that a customer can always have access to the central office network, even during a commercial power outage. This feature requires the use of single line telephones supported by SLI-EB ETUs. If power fails to support the Electra MarkII CCUs, the CO Tip and Ring are automatically transferred to the Tip and Ring of a preselected (and cross connected) single line telephone; these SLTs may function in the system during normal operation, or can be only for use during power failure.

**PRIME LINE ASSIGNMENT** simplifies the use of the Multiline Terminals further, by providing automatic selection of a line key. When a Multiline Terminal programmed for *Prime Line Assignment* goes off-hook, the assigned extension or outside line key is seized automatically. This feature always seizes the line key when the line is IDLE.

Variations of this feature are accomplished when the system is programmed for *Prime Line* pick up for incoming calls, or the terminal is programmed for *Ring Line Preference* and *Prime Line*.

**PRIVACY ON ALL CALLS** provides the secure knowledge that no one can listen to your ongoing conversation. Only the person holding a conversation can allow another party to enter the conversation (via *Add-On Conference*). All lines in the system are provided with complete *Privacy*.

**PRIVATE LINES** can be assigned via the *Flexible Line Assignment* feature. Restriction assignments can be used to assure that a line is made private.

**PROGRAMMING FROM Multiline Terminals** of system functions is permitted locally at any of up to three ETE-16D-1 Multiline Terminal positions, or remotely at a PC, using an RAA-E unit. Some changes to the system program can be entered while the system is in full operation. Other changes can be entered and will take effect when the affected circuits and stations are IDLE.

**PUSHBUTTON DIAL - DTMF** or **DP-** are provided on all Electra MarkII Multiline Terminals and only DTMF dialing is possible with single line telephones, for simplified and speedy calling. Trunks are assigned, on an individual or trunk group basis, to generate either Dual-Tone Multi-Frequency (DTMF) or Dial Pulse (DP) dialing signals.

A **RECALL BUTTON** is provided on all Electra MarkII Multiline Terminals. This button can be used to generate either a hook flash to access features provided by an outside exchange, or to abandon a call, while retaining the outside line for origination of another call.

The Electra MarkII System can be programmed from a remote location with the **REMOTE ADMINISTRATION ADAPTOR RAA-E**. The *RAA-E*, which is located at the job site, provides access to the system with the assistance of the following equipment:

Job Site:

1. CPU-EB ETU
2. ESI-EB (one circuit) ETU
3. A modem (212A compatible with auto answer)
4. SLI-E( ) (one circuit) ETU
5. RSG-E unit

Remote Location:

1. A modem
2. NEC PC8300 Laptop Computer
3. NEC PC8231A Floppy Disk Drive
4. RAA Host Disk

The **RESIDENT SYSTEM PROGRAM** is located in the memory of the CPU-EB or CPU-E ETUs and enables the system to fully function, after a first initialization. The CPU scans the installed circuits and Multiline Terminals and assigns standard (default) values. This allows system operation before programming has begun. This provides the installer a method to test the system for normal operation, thereby allowing later problems to be identified as probable programming errors.

**RESTRICTION (INCOMING)** allows the assignment, on a per station per trunk group basis, of restricting a station's ability to answer incoming calls. This is required for *Private Line* assignment.

**RESTRICTION (OUTGOING)** allows the assignment, on a per station per trunk group basis, of restricting outgoing calls. This is required for *Private Line* assignment.

**RINGING LINE PREFERENCE** makes call handling more efficient, and is especially useful for *Attendant Positions*. Any Multiline Terminal can be programmed to seize any ringing incoming call, to that station, by going off-hook.

**SAVE and REPEAT** allows the storage of telephone numbers (up to 16 digits). Any line key (except PE) can be programmed to become a *Save and Repeat* key. After dialing an outside number, depression of this line key will cause the system to memorize the number dialed and light the associated red LED. Depressing this key, when the station is receiving dial tone, will cause the number to be redialed. The number will be eliminated from memory when redialed. Each Multiline Terminal within the Electra MarkII system can have at least one *Save and Repeat* key, until the system limit of eighty *Save and Repeat* keys is reached.

**SINGLE LINE TELEPHONES** are used when cable distances exceed the allowed maximum length for Multiline Terminals (see Chapter 2 specs). The Electra MarkII provides all single line telephones access to *most features* available to the Multiline Terminals. The system capacity for such telephones is seventy-six, which requires the support of up to four MFR-EA ETUs and up to three RSG-E Ringing Supply Generators, and up to nineteen SLI-E( ) ETUs. A system must contain at least one ESI-E( ) ETU and ETE-16D-1 Multiline Terminal for programming and call processing.

**STATION CAMP-ON** allows a call to be transferred to an extension, even when it is busy. If the *Camp-On* is disallowed for any reason or goes unanswered for a preprogrammed length of time, it will recall to the station that initiated the *Camp-On*. *Camp-On* capabilities are controlled by station *Class of Service*. No more than one *Camp-On* per station is possible.

**STATION LOCKOUT** provides added call security by allowing any station user (programmed thru *Class of Service*) to electronically remove his station from service by dialing a system lockout access code and then a private lockout code; dialing these same codes again restores the station to service. The private code is established and changed by the individual station user. If the private code is displaced or not readily available, the attendant can override the station lockout, restore the station to normal operation, and reset the private code to its default value.

**STATION MESSAGE DETAIL RECORDING (SMDR-E)** is an optional ETU which provides detailed call record information about the telephone

usage of the system. Call records are generated for incoming, outgoing, conferenced, and transferred outside calls. Station identification, trunk identification, time of origination, call duration, and account codes are among the information provided. To retrieve these reports, a locally provided printing or call accounting device compatible with a standard RS232C output, must be installed. Whether or not incoming calls will generate a record can be selected via system programming.

**SPEED DIAL (Station)** is provided to every station within the Electra MarkII system. Because each station type has its own unique capabilities, access to the individual twenty speed dial buffers may vary.

1. ETE-6-1, dial access to 20 memories.
2. ETE-6D-1, dial access to 10 memories and direct selection to 10 more.
3. ETE-16D-1, direct selection and/or dial access to the 20 memories.
4. ETE-16K-1, direct selection to 110 memories.
5. Single Line Telephone - dial access to 20 memories.

Each memory location has the capability of storing up to 16 digits (*System Speed Dial* numbers can be stored within a *Station Speed Dial* memory buffer of Multiline Terminals to increase this capacity). Each memory location is programmed by the station user.

**STEP CALL** is a feature provided by the CPU-EB ETU. *Step Calling* allows station users who attempt an internal, *Transfer* call and reach a busy extension or call park location, to call another station by dialing the last digit (after you hear a busy or *Call Waiting* tone) of the extension number you wish to step to; provided both numbers called differ only by the last (signles) digit. This procedure can be used until an idle station or call part location is found.

**SPEED DIAL (System)** provides eighty memory buffers available for usage system wide; this complements the individual twenty memories available for each station. Only the *Attendant Positions* can program these 80 memory locations. These memory locations have an *Override* option, for *Code Restriction* assignments, in blocks. When programmed for *Tenant Service*, the system can

proportion the access to the eighty memory locations and *Code Restriction* on a per tenant basis.

**TENANT SERVICE** allows the system to be independently shared by up to three separate tenants. Separate access to outside lines, attendants, *System Speed Dial* memories, *Night Chimes*, and *Night Call Pickup* can be provided.

**E&M TIE LINES** are accommodated by the TLI-E ETU. Each *Tie Line* supported can be any combination of loop dial, 2 wire E&M, or 4 wire E&M; Type 1 or Type 5 E&M tie lines must be rotary dial.

Incoming *Tie Line* calls cannot access other outside lines

**TONE OVERRIDE** allows station users to signal a busy extension they want to talk to. Once alerted, a Multiline Terminal user can immediately answer the *Override* by depressing the *Answer Key* (placing their existing caller on *Consultation Hold*). Single line telephones can place their existing call on *Exclusive Hold* and answer the override call.

To further assist in identification of calls, **TRUNK GROUP NAME ASSIGNMENT** allows Multiline Terminal (with LCD) users to receive the *Name* of a *Trunk Group* that is ringing in or being transferred to the primary extension. Once the call is answered the *Trunk Group Name* disappears and is replaced by the *Elapsed Call Timer* indication.

Each *Trunk Group's Name* is individually programmed by the installer, and can be up to eight characters; this feature requires the system to utilize a CPU-EB ETU.

With the support of a CPU-EB ETU the *Attendant Positions* have the ability of **TRUNK/MFR TEST** and **BUSY OUT**. Each individual trunk circuit can be examined to determine if it is in good working order. If a particular trunk is found to be inoperable, the attendant can busy it out. When the problem is corrected, the trunk circuit can be restored.

Additionally, single line telephones can be used to test the dual tone multi-frequency receiver circuits (on the MFR-EA ETUs) to determine if they are operational. If a problem is detected, an attendant can busy out the defective circuit. Once the problem is corrected, the attendant can restore the circuit.

**TRUNK QUEUING** allows station users to increase their call processing efficiency in a high traffic environment. The system must be supported with a CPU-EB ETU, and the stations dial access to the busy trunk group cannot be via LCR.

Station users who are denied a trunk or *Tie Line* (after dial access via an extension) when all trunks in the trunk group are busy, can queue onto the trunk group by a dial access code. When a trunk in that trunk group becomes idle, the system reserves it and initiates a *Recall* indication to the queuing station's primary extension (when station and extension are idle).

**TWO COLOR LEDs** are provided on the line keys of all Multiline Terminals (except the ETE-6-1) to more rapidly distinguish between the status of lines. A green LED provides the Multiline Terminal user with such status information as *I-Hold*, *I-Use* and *Hold Recall*. A red LED provides indication of all other line status. The *DSS/BLF Console* is also provided with two color LEDs, on buttons programmed for direct access to extensions.

**UNIVERSAL PORTS** provide complete flexibility for installation and cost savings for the end-user. The Electra MarkII system allows the installation of any type interface circuit board into any interface slot. This allows maximum utilization of the CCUs, minimizing hardware costs.

**USER PROGRAMMING CAPABILITY** reduces installer time and involvement and allows the user to make any required changes while the system retains its versatility. Each Multiline Terminal user can program such features as *Off-Hook Ringing*, internal *Voice or Tone Signaling*, *Ring Tone* selection, *Station Speed Dial* memories, *Background Music* channel, direct station selection assignment, and direct feature access assignment.

The ETE-16K-1 Multiline Terminal additionally provides the ability to program an 11 page directory, offering button access to memories (up to 110) used for *Speed Dial*, direct station selection, and direct feature access.

**UNSUPERVISED CONFERENCE** provides the ability for Multiline Terminal users to establish a *Conference* call between two Central Office lines on one line key and to place the conference on hold and hang up while the *Conference* continues, freeing their

Multiline Terminal for other uses. The *Conference* may be re-entered at any time by the Multiline Terminal user. After a predetermined time interval, an audible signal is provided to the Multiline Terminal, as a reminder of the ongoing *Unsupervised Conference*. Single line telephones can also perform this type of *Conference* call.

**VIRTUAL EXTENSIONS** are 48 software extensions available beyond the maximum of 80 station based extensions. *Virtual Extensions* can be assigned to line keys as desired. The system total

cannot contain more than 128 extensions, which is comprised of the 48 *Virtual Extensions* and the 80 station extensions.

**VOICE MAIL INTERFACE** is an option that provides the necessary interfacing of the Electra MarkII system to a locally provided *Voice Mail* system. *Voice Mail Message Waiting* display is also supported. This feature requires a VMI-E ETU to be installed in an interface slot as well as the support of an RSG-E unit and MFR-EA ETU, which may be shared with single line telephones in the system.

**SECTION 150  
 LCD INDICATIONS**

DISPLAY	LOCATION	DEFINITION
INITIALIZE	All Stations	System is Initializing
LK12 CO CALL	Ring Assigned Station	Incoming CO Call
LK16 TR CO CALL	Receiving Station	Receiving CO Transfer
ELAPSED 01:35	CO Calling/Called Station	CO Call Duration
CONFERENCE 03:46	Conference Originating Station	CO Conference Elapsed Time
LK16 NEIL.A 201	Called Station	Receiving Internal Call (from 201)
LK16 TR EXT CALL	Receiving Station	Receiving Internal Transfer
LK15 RECALL	Originator	Hold Recall
LK16 RECALL 201	Originator	Recall for Unanswered Transfer/Camp-On (from 201)
DENIED	Originator	Access Denied
SAVE & REPEAT	Originator	Save and Repeat Number is Stored
CAMP ON DENIED	Originator	Unable to Set Camp-On Call
CAMP ON CO CALL	Called Station	Receive CO Camp-On Call
CAMP ON EXT 342	Called Station	Receive Internal Camp-On Call (from 342)
OVERRIDE 320	Called Party	Receive Tone Override (From 320)
CO LINE	Originator	On CO Line Key (Before Dialing)
EXT LINE	Originator	On EXT Line Key (Before Dialing)
NEIL.A 201	Called/Calling Station	During Internal Call
CONFERENCE	Conference Party	During Conference
CALL WAITING 106	Originator	Call Waiting (on 106)
BUSY 289	Originator	Called Station is Busy (With Station No.)
FWD ALL 298 → 209	Originator	Confirming Call Forward Status
FWD ALL NOT SET	Originator	Confirming Call Forward Status
FWD BNA 298 → 218	Originator	Confirming Call Forward Status
FWD BNA NOT SET	Originator	Confirming Call Forward Status
FWD SET DENIED	Originator	Unable to Set Call Forward
FWD CANCEL	Originator	Confirming Call Forward Status

DISPLAY	LOCATION	DEFINITION
FWD 256 → 342	Calling Party	Call is Being Forwarded
VACANT	Originator	Speed Dial Memory Buffer Status
ACCOUNT CODE ?	Originator	Prompt for Entering Account Code
NIGHT MODE SET	Attendant	Confirmation of Night Mode
NIGHT MODE CNCL	Attendant	Confirmation of Night Mode Cancel
LOCKOUT CODE ?	Originator	Prompt to Set Lockout Code
LOCKOUT CANCEL	Originator	Confirmation of Lockout Cancel
INCORRECT CODE	Originator	Wrong Lockout Code Entered
1326436	Originator	Number dialed or Station Speed Dial Contents
MUSIC NBR?	Originator	Prompt for Station BGM Selection
MUSIC 1 SET	Originator	Confirmation of Station BGM Channel
EXT NUMBER?	Originator	Prompt in Call Pickup Directed
TRANSFER → 213	Calling Party	Confirmation of Ringing Extension Call Transfer (to 213)
CAMP ON → 345	Originator, Calling Party	Confirmation of Camp-On Transfer (to 345)
OVERRIDE → 213	Originator	Confirmation of Tone Override (to 213)
07:43 SEP 02 SUN	All Stations	Clock/Calendar
12:31 NEIL.A      201	Called Station	Callback Request (Message) (from 201)
11:53 ATT            0	Called Station	Message Waiting (from 0)
CALLBACK SET	Originator	Confirmation of Automatic Callback
CALLBACK DENIED	Originator	Denial of Automatic Callback
MESSAGE SET      222	Originator	Confirmation of Callback Request Set (to 222)
MESSAGE DENIED	Originator	Denial of Callback Request Attempt
INT ZONE 1 PAGE	Originator with DSS/BLF	Internal Zone Paging
INT ALL CALL	Originator with DSS/BLF	Internal All Call
INT ALLZONE PAGE	Originator with DSS/BLF	Internal All Zone Paging
SPEAKER 2 PAGE	Originator with DSS/BLF	External Speaker Paging
ALL SPEAKER PAGE	Originator with DSS/BLF	All External Speaker Paging
MSG 2	Called Station	Two Messages on Queue
NIGHT	All Stations	System in Night Mode
FWD	Originator	Station in Call Forward Mode

DISPLAY	LOCATION	DEFINITION
CALLBACK 163	Originator	Recall by Automatic Callback (from 163)
CALCULATOR BUSY	Originator	All Calculator Circuits Busy
CURRENT CODE ?	Originator	Prompt During Lockout Code Revision
NEW CODE ?	Originator	Prompt During Lockout Code Revision
NEW CODE SET	Originator	Confirmation of New Secret Code
LOCKOUT SET 298	Originator	Confirmation of Lockout Status (on 298)
LOCKOUT DENIED	Originator	Unable to set Lockout
0.	Originator	Calculator On
S20	Originator	System Speed Dial Memory Number
CK 3 CO CALL	Called Attendant	Incoming CO Call on Add-On Module
LK16 TIE LINE	Ring Assigned Station	Incoming Tie line call on Primary Extension (with Trunk Group Name Assigned)
QUEUE SET	Originator	Trunk Queuing is set
LK16 QUEUE	Originator	Informing of an Available Trunk
PARK NBR?	Originator	Prompt for Parking Area Selection
PARK3 SET	Originator	Confirmation of Call Park
BUSY PARK	Originator	Parking Area Attempted is Busy
LK16 PARK3 RECALL	Originator	Recall for Unanswered Parked Call
CO12 NOT INSTALL	Attendant	Confirmation of Trunk Test (For Trunks Not Installed)
CO11 NORMAL	Attendant	Confirmation of Trunk Test (For Trunks Installed)
CO11 BUSY	Attendant	Confirmation of Trunk Test (For Trunks In Use)
CO11 BUSYOUT	Attendant	Confirmation of Trunk Busied Out
MFR3 NOT INSTALL	Attendant	Confirmation of MFR Test (For MFR not Installed)
MFR2 NORMAL	Attendant	Confirmation of MFR Test (For MFR Installed)
MFR2 BUSYOUT	Attendant	Confirmation of MFR Busied Out
DATA PATH BUSY	Originator	Data Path of Called Station is Busy
NO DATA PATH123	Originator	At Station 123: No data Adaptor Installed; No Data Path Available; No DT and DR key Programmed



DISPLAY	LOCATION	DEFINITION
NOT READY 123	Originator	Data Adaptor or Data Terminal Equipment at Station 123 is Not Ready
DATA TO 123	Originator	Originating a Data Call
DATA FROM 123	Receiving Station	Receiving a Data Call
DATA PATH TO 123	Originator	During Data Switching
MODEM BUSY	Originator	All Modems are Busy
DATA END 121	Originator	End Data Switching by Depressing either DT or DR key. If Required, Turn Off DTFE
DATA ERROR	Originator	Error Indication
DATA RESERVE 121	Originator	Reservation for Outgoing Data Call
DATA OFF	Calling/Called Stations	End of Data Switching by ER (Equipment Ready) Signal Going Off
DATA TO MODEM3	Originator	Modem is Being Activated
NOT READY MODEM3	Originator	Modem is Not Ready
DATA ONTO MODEM3	Originator	During Data Switching with Outside Party via Modem

NOTE: LCD Displays shown in ***BOLD ITALIC*** in this chart FLASH on the terminals LCD.

## SECTION 160 FEATURE ACCESS CODES (NUMBERING PLAN)

### 160.1 Codes Dialed While Receiving Dial Tone or Feature Access Tone

FEATURE	CONDITION	CODE (Set in Default)
Call to Attendant	Fixed	0
Extension Numbering (3 or 4 digit)	Flexible	xxx or xxxx
Call Forward-All Calls: <b>Station</b>	Confirm	41
	Set	41xxx
	Cancel	41*
Call Forward-Busy/No Answer: <b>Station</b>	Confirm	42
	Set	42xxx
	Cancel	42*

FEATURE	CONDITION	CODE
Call Forward-All Calls: <b>Attendant</b>	Confirm Set Cancel	Flexible Flexible Flexible 44xxx 44xxx yyy 44xxx *
Call ForwardBusy/No Answer: <b>Attendant</b>	Confirm Set Cancel	Flexible Flexible Flexible 45xxx 45xxx yyy 45xxx *
Call Forward-All Calls: <b>Destination</b>	Confirm Set Cancel	Flexible Flexible Flexible 47xxx 47xxx yyy 47xxx*
Call Forward-Busy/No Answer: <b>Destination</b>	Confirm Set Cancel	Flexible Flexible Flexible 48xxx 48xxx yyy 48xxx*
BGM Over Multiline Terminal Speaker	Cancel Set	Flexible Flexible 49 49 + 1 or 2
Single Line Telephone Exclusive Hold: Set or Retrieve		Flexible 4# (after flash)
All Call Voice Page via Multiline Terminal Speakers		Flexible 550
Internal Paging: <b>Zone 1</b>		Flexible 551
<b>Zone 2</b>		Flexible 552
<b>Zone 3</b>		Flexible 553
<b>All Zones</b>		Flexible 554
<b>Meet-me Answer</b>		Flexible 556
External Paging: <b>Zone 1</b>		Flexible 561
<b>Zone 2</b>		Flexible 562
<b>Zone 3</b>		Flexible 563
<b>All Zones</b>		Flexible 564
<b>Meet-Me Answer</b>		Flexible 566
Station Speed Dial Program for Single Line Telephones		Flexible 58
Station Lockout: <b>Change Special Code</b>		Flexible 59 + *
Night Call Pickup		Flexible 60

FEATURE	CONDITION	CODE
Station Lockout: Set or Cancel	Flexible	61 + Special Code
Cancel from Attendant	Flexible	62xxx
Station Not Locked Out: Set Default Value from Attendant	Flexible	62xxx*
Night Mode Set or Cancel (Attendant Only)	Flexible	68
Call Pickup: Directed	Flexible	6#xxx
Group	Flexible	6*
Trunk Access: Group 3 ~ 8	Flexible	70 ~ 75
Group 2	Flexible	8
Group 1	Fixed	9
Last Number Redial	Fixed	*
Station Speed Dial Access	Fixed	# + 00~19
System Speed Dial Access	Fixed	# + 20~99
Off-Line For System Programming	Fixed	# * 0
Voice Mail Message Set	Flexible	541xxx
Voice Mail Message Cancel	Flexible	54*xxx
Account Code Entry	Fixed	##
Call Park Set: (On second dial tone)	Flexible	4*x (x=0~9)
Retrieve (With Station No.) (On dial tone)		4*x (x=0~9)
Trunk Test (Attendant Only)	Flexible	67xx
MFR Test (SLT only)	Flexible	67xx
Trunk/MFR Busy Out (Attendant Only)	Flexible	57xx#
Trunk/MFR Restore (Attendant Only)	Flexible	57xx*

**160.2 Codes Dialed When Not Receiving Dial Tone or Feature Access Tone.**

FEATURE	CONDITION	CODE
Change Voice Announce to Tone Signal and Tone Signal to Voice Announce	Fixed	1
Call Back Messages Inspect (Receiving Station On-Hook)	Fixed	1
Set (Calling Station Off-Hook)	Flexible	#
Cancel (Receiving Station On-Hook)	Fixed	*
Tone Override/Attendant Override	Flexible	* 0
Automatic Callback : Set	Flexible	* 1
Trunk Queuing	Fixed	* 1

## SECTION 170 EQUIPMENT IDENTIFICATION

DESIGNATION	DESCRIPTION	MAXIMUM PER SYSTEM
ESE-32B-1 CCU	BASIC CENTRAL CONTROL UNIT	1
ESE-32E-1 CCU	EXPANSION CENTRAL CONTROL UNIT	2
PSE-AD-1 PSU	AC/DC POWER SUPPLY UNIT	3
PSE-DD-1 PSU	DC/DC POWER SUPPLY UNIT	3
RSG-E	RINGING SUPPLY GENERATOR	3
RAA-E	REMOTE ADMINISTRATION ADAPTOR	1
CPU-EB ETU	CENTRAL PROCESSING UNIT (replaces CPU-E)	1
MMC-E ETU	MODULE MEMORY AND CONTROLLER	2
TSW-E ETU	TIME DIVISION SWITCH	1
COI-E ETU	CENTRAL OFFICE LINE INTERFACE	10
TLI-E ETU	E&M Tie LINE and DID LINE INTERFACE	20
ESI-EA ETU	ELECTRONIC STATION INTERFACE	20
ESI-EB ETU	ELECTRONIC STATION INTERFACE with OFF-HOOK VOICE ANNOUNCEMENT and DATA	20
SLI-EA ETU	SINGLE LINE INTERFACE	20
SLI-EB ETU	SINGLE LINE INTERFACE with MESSAGE WAITING and POWER FAILURE TRANSFER	20
MFR-EA ETU	DUAL-TONE MULTI-FREQUENCY RECEIVER	4
CNF-E ETU	CONFERENCE CIRCUIT	4
ECR-E ETU	EXTERNAL CONTROL RELAYS	1
VMI-E ETU	VOICE MAIL INTERFACE	1
SMDR-E ETU	STATION MESSAGE DETAIL RECORDING	1
LCR-E ETU	LEAST COST ROUTING	1
ETE-6-1 TEL	6 LINE MULTILINE TERMINAL	78
ETE-6D-1 TEL	6 LINE MULTILINE TERMINAL with DISPLAY	78
ETE-16D-1 TEL	16 LINE MULTILINE TERMINAL with DISPLAY (SEE NOTE)	30 (80)
ETE-16K-1 TEL	16 LINE MULTILINE TERMINAL with DIRECTORY Display	30
EDE-30-1 DSS/BLF	30 BUTTON DIRECT STATION SELECTION/ BUSY LAMP FIELD CONSOLE	6*
EDE-30-1	CO ADD-ON MODULE	4*
HFU-E	HANDSFREE UNIT	80
DPA-E	DUAL PATH ADAPTOR	80**
ADA-E	ANCILLARY DEVICE ADAPTOR	80
WMU-E	WALL MOUNT UNIT	80
DTA-E	DATA TERMINAL ADAPTOR	80**

**NOTE:** No more than 10 ETE-16D-1 Multiline Terminals with BLF function assigned can be connected to each ESE-32B-1 and ESE-32E-1 CCU installed. \*The EDE-30-1 system maximum is six units, when used as BLF, Add-On Module and /or DSS/BLF. \*\*Refer to description of DPA-E and DTA-E.

## 170.1 General Information

One set of Job Specifications (ND-20234) and a wall mounting template are included with the ESE-32B-1 CCU. All optional equipment such as external amplifier, MOH source, BGM source, external speaker, etc. must be locally provided.

## 170.2 Equipment Description

### 1. ESE-32B-1 CCU

This CCU is the basic Central Control Unit. This steel cabinet is designed to accommodate other expansion CCUs. A PSE-AD-1 or PSE-DD-1 power supply is required to provide service. It also requires a CPU-E or CPU-EB and a TSW-E ETU. The ESE-32B-1 CCU provides 8 slots in the interface card section that can support 4 ports each. The ETUs that can be installed in these 8 slots are: COI-E, TLI-E, ESI-EA, ESI-EB, SLI-EA, SLI-EB, CNF-E, MFR-EA, ECR-E and VMI-E ETUs.

In addition, there are 3 slots in the common control/optional common card section. 2 of these 3 slots are occupied by the CPU-EB and the TSW-E ETUs. One slot can be used to install an optional common card such as an SMDR-E or an LCR-E ETU.

When slot 8 in the interface card section, is not occupied, it can be used to install another optional common card.

The ESE-32B-1 CCU provides service for up to 32 ports. Maximum 1 per system.

### 2. ESE-32E-1 CCU

This CCU is the expansion Central Control Unit. This steel cabinet is designed to be stacked on top of the ESE-32B-1 CCU or on top of another ESE-32E-1 CCU; **it is not a stand-alone unit and must be used in conjunction with the ESE-32B-1 CCU.**

The ESE-32E-1 CCUs require a PSE-AD-1 or PSE-DD-1 power supply to provide service to all equipment supported by this CCU. It also requires an MMC-E ETU to control this equipment.

The ESE-32E-1 CCU provides 8 slots in the interface card section; each section can support 4 ports. The ETUs that can be installed in these 8 slots are: COI-E, TLI-E, MFR-EA, ESI-EA, ESI-EB, SLI-EA, SLI-EB, CNF-E, ECR-E, and VMI-E ETUs.

In addition, there are 3 slots in the common control/optional common card section. 1 of these 3 slots is occupied by the MMC-E ETU. 2 slots can be used to install optional cards such as LCR-E and SMDR-E ETUs.

A maximum of two ESE-32E-1 CCUs can be mounted. The first expansion CCU expands the total system capacity up to 64 ports. Two expansion CCUs provide service for up to 96 ports.

### 3. PSE-AD-1 PSU

The PSE-AD-1 PSU is an AC/DC power supply, that when used, is mounted in each CCU. This PSU converts 117 VAC into the necessary voltages required to operate the system.

This PSU provides the required DC voltages (-5V, +5V, -24V) to ETUs installed in the CCU and to the devices connected to the CCU.

### 4. PSE-DD-1 PSU

This power supply accepts a DC input voltage of -48VDC and converts it to the necessary operating DC voltages of -5V, +5V and -24V, required by a CCU.

This PSU allows the system to be powered from a locally provided nominal -48VDC power source, thereby avoiding disruptions of system operations caused by commercial power failures and brownouts.

**Each CCU requires either a PSE-DD-1 or PSE-AD-1; these two PSUs cannot be mixed within a system.**

### 5. RSG-E Unit

The RSG-E unit is the ringing supply generator required to provide ringing signal to single line telephones (SLTs) and a voice mail system.

The RSG-E unit is mounted into the CCU to support up to 32 SLTs and/or voice mail.

The RSG-E unit installed in a CCU supplies ringing signal to SLTs *Voice Mail* and modems connected to that CCU. One RSG-E unit can supply ringing signal to an adjacent CCU, provided the combined CCU ringing requirements are not excessive.

### 6. RAA-E

The Remote Administration Adaptor (RAA-E) provides access to the Electra MarkII system program from a remote location. The system program can be

can be changed, defective ports can be busied out or put back into service.

To accomplish this function, the following equipment is required:

- a. At job Site:
  1. CPU-EB ETU
  2. RAA-E unit
  3. ESI-E( ) ETU (one circuit for RAA-E termination)
  4. Modem (212A compatible with auto answer)
  5. SLI-E( ) (one circuit for Modem termination if required)
  6. RSG-E unit (if Modem terminates on an SLI-E( ) ETU)
- b. At the Remote Location:
  1. Modem
  2. NEC PC8300 Laptop Computer
  3. NEC PC8231A Floppy Disk Drive
  4. RAA Host Disc.

#### 7. CPU-E and CPU-EB ETU

The CPU-E or CPU-EB ETU is the Central Processing Unit and the heart of this system.

It provides overall control via the main processor (16 bit microprocessor) by communicating with distributed processors mounted on the TSW-E and MMC-E ETUs.

The CPU-E or CPU-EB ETU must be installed in the ESE-32B-1 CCU.

#### 8. MMC-E ETU

The MMC-E ETU is the Module Memory and Controller Unit required for each ESE-32E-1 CCU. It controls data transmission between the CPU-( ) ETU and the interface cards installed in the ESE-32E-1 CCU in which the MMC-E ETU is installed.

Data from and to both the CPU-EB ETU and each interface card is temporarily stored in the memories of the MMC-E ETU.

The MMC-E ETU contains a 4 bit microprocessor.

#### 9. TSW-E ETU

The TSW-E ETU is the Time Division Switch Unit required for the ESE-32B-1 CCU

Additionally, it supplies all the tones required in processing telephone calls and it also establishes paths between stations and outside lines, extension lines or call process tones.

The TSW-E ETU also has functions similar to the MMC-E ETU within the ESE-32B-1 CCU, and provides the source output for external paging.

To connect MOH and BGM sources, the TSW-E ETU houses audio digitizer circuits to change analog signals to digital signals.

#### 10. COI-E ETU

The COI-E ETU is the Central Office Line Interface Unit that contains circuitry for outside ring detection, hold, dialing, and control function.

Each COI-E ETU provides four identical circuits to serve up to four CO trunks which can be any mix of *Loop Start* or *Ground Start Trunks*, DTMF or dial pulse dialing.

A maximum of 10 COI-E ETUs can be installed per system.

#### 11. TLI-E ETU

The TLI-E ETU provides for the termination and operation of up to 2 E&M *Tie Lines* (loop dial, 2 wire E&M, or 4 wire E&M, Type 1 or Type 5) and 10pps pulse dial *DID* line. Wink, delayed, second dial tone or immediate start loop signaling are supported. Along with the possible terminations accommodated with the COI-E ETU, the system maximum of 40 outside lines is observed.

#### 12. ESI-EA ETU

The ESI-EA ETU is the Electronic Station Interface Unit required to provide data control and voice service to the Multiline Terminals without the off-hook announcement feature. It can also accommodate the *DSS/BLF Console* and *CO Add-On Modules*.

Each ESI-EA ETU contains four identical circuits to serve up to four Multiline Terminals which can be any mix of Multiline Terminals or *DSS/BLF Consoles* or *CO Add-On Modules*. A maximum of 20 ESI-EA ETUs can be installed per system.

#### 13. ESI-EB ETU

The ESI-EB ETU is the Electronic Station Interface Unit which includes the functions of the ESI-EA ETU and supplies the Multiline Terminals (with a DPA-E

and/or a DTA-E unit installed) with the off-hook announcement and/or Data Communication features.

Each ESI-EB ETU contains four identical circuits to serve up to four Multiline Terminals which can be any mix of Multiline Terminals or *DSS/BLF Consoles* or *CO Add-On Modules*.

**NOTE:** The *Data Switching* feature has a direct impact on the *Dual Path* features' system maximum and vice-versa. When a station requires both *Dual Path* and *Data Switching*, it needs the use of three paths (each ESI-EB ETU contains 8 paths utilized by the four ports), therefore removing the second path from the adjacent port. Only ports *one* and *three*, of the ESI-EB ETU, can have both features, while ports *two* and *four* can have either feature (if the adjacent port does not have both).

A maximum of 20 ESI-EB ETUs can be installed per system.

#### 14. SLI-EA ETU

The SLI-EA ETU is the Single Line Telephone Interface Unit which provides circuitry for loop status detection, talk battery, sending ringing signal from the RSG-E unit to SLTs, and voice service to SLTs.

Each SLI-EA ETU contains four identical circuits to serve up to four SLTs.

A maximum of 18 SLI-EA ETUs can be installed per system.

#### 15. SLI-EB ETU

The SLI-EB ETU is the Single Line Telephone Interface Unit which includes the functions of the SLI-EA ETU, and provides *Message Waiting* indication to SLTs equipped with a *Message Waiting* lamp.

Each SLI-EB ETU contains four identical circuits to serve up to four SLTs.

The SLI-EB ETU is required for use with power failure transfer of COs to SLTs.

A maximum of 18 SLI-EB ETUs can be installed per system.

#### 16. MFR-EA ETU

The MFR-EA ETU is the Dual Tone Multi-Frequency Receiver Unit that is used to receive and translate the

DTMF signals generated by SLTs and *Voice Mail* System.

Each MFR-EA ETU provides two receiver circuits shared by SLTs in a system. When no SLTs or VMI-E ETUs are installed in a system, MFR-EA ETUs are not required. A maximum of 4 MFR-EA ETUs can be installed per system.

#### 17. CNF-E ETU

The CNF-E ETU is the *Conference* Unit that is used to establish a non-amplified *Conference* between up to 4 parties, both outside lines and extensions. No more than two outside lines can participate in a *Conference* call.

A CNF-E ETU is required for each *Conference* in progress.

A maximum of 4 CNF-E ETUs can be installed per system.

#### 18. SMDR-E ETU

The SMDR-E ETU is the Station Message Detail Recording Unit that provides the user with detailed call reports on the usage of the system. Detailed call reports include number dialed, time of initiated / received call, trunk number, trunk group, type of call (outgoing, incoming, transferred, conferenced), station number, length of call, and date. A printer or other peripheral device must be connected to the RS-232C connector from the SMDR-E ETU. The real time clock is protected against power loss by a mounted battery. Data output speed range is from 300 to 4800 baud and is set by a switch mounted on the SMDR-E ETU. A maximum of 1 SMDR-E ETU can be installed per system.

#### 19. ECR-E ETU

The ECR-E ETU is the External Control Relay Unit that provides control circuits to access one or all three *External Paging Zones*. If the locally provided amplifier is a bothway amplifier, two way paging is available. The ECR-E ETU also provides circuitry for *External Ringing* applications and *Night Chime* control in the night mode.

The ECR-E ETU also contains input jacks for two music sources to be used to supply *Background Music* via Multiline Terminal speakers.

A maximum of 1 ECR-E ETU can be installed per system.

## 20. LCR-ETU

The LCR-E ETU is the Least Cost Routing Unit that provides the user with the least costly available route when placing outside calls.

The real time clock is protected against power loss by a mounted battery. Data output speed range is from 150 to 9600 baud and is set by a switch mounted on the LCR-E ETU.

A maximum of 1 LCR-E ETU can be installed per system. Data input (programming) to the LCR is provided by a portable computer.

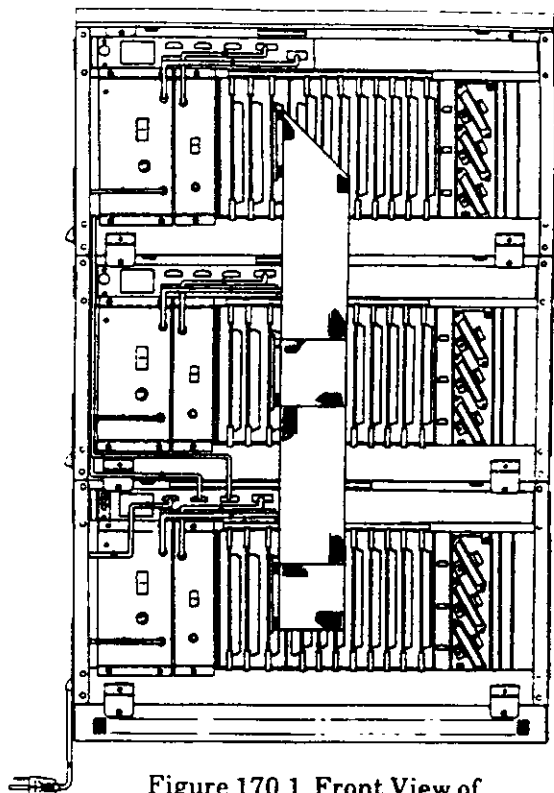

Figure 170.1 Front View of  
Electra MarkII

## 21. VMI-E ETU

The VMI-E ETU is the Voice Mail Interface Unit that provides circuitry for Voice Mail integration (including Message Waiting indication) to this system.

Each VMI-E ETU contains four identical circuits to serve up to four mail entry ports.

A CPU-EB ETU is required to support the connection of an SLT or DTMF controlled dictation equipment to VMI-E ETU.

A maximum of 1 VMI-E ETU can be installed per system. The VMI-E ETU requires the support of both an RSG-E unit and an MFR-EA ETU.

## 22. ETE-6-1 TEL

The ETE-6-1 TEL is a fully modular digital Multiline Terminal with 6 line keys, 7 function keys and 1 message wait LED.

Line keys can be assigned for outside lines, extension lines, DND (Do Not Disturb), S & R (Save and Repeat), DT (Data Transmit) or DR (Data Receive).

This Multiline Terminal requires twisted 2 pair cabling to the MDF (Main Distribution Frame) or IDF (Intermediate Distribution Frame).

## 23. ETE-6D-1 TEL

The ETE-6D-1 TEL is a fully modular digital Multiline Terminal with 6 line keys, 7 function keys and 10 programmable Feature Access keys for DSS, station speed dialing or feature access codes.

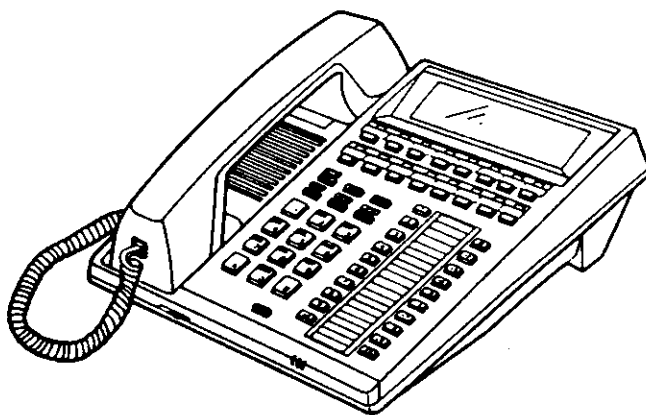

Figure 170.2 ETE-16D-1 Telephone

A two color LED is provided to each line key which can be used for outside lines, extension lines, Data Transmit and Data Receive, DND or S & R features.

This Multiline Terminal is equipped with a 2 line LCD with 16 characters per line.

The ETE-6D-1 terminal requires twisted 2 pair cabling to the MDF or the IDF.



#### 24. ETE-16D-1 TEL

The ETE-16D-1 TEL is a fully modular digital Multiline Terminal with 16 line keys, 7 function keys and 20 programmable **Feature Access** keys for DSS with BLF indications, *Station Speed Dialing* or feature access codes.

A two color LED is provided to each line key which can be used for outside lines, extension lines, Data Transmit and Data Receive, DND or S & R features.

This Multiline Terminal is equipped with a 2 line LCD with 16 characters per line.

The ETE-16D-1 TEL requires twisted 2 pair cabling to the MDF or the IDF.

#### 25. ETE-16K-1 TEL

The ETE-16K-1 TEL is a fully modular digital Multiline Terminal with 16 line keys, 7 function keys and 10 programmable **Feature Access** keys assigned for DSS/BLF, *Station Speed Dialing* or feature access codes.

The 10 programmable **Feature Access** keys are associated with a 7 line, 16 digit, LCD with 11 pages. The desired page can be selected by the DIR (Directory) key. A total of 110 programmable designation buffers are available.

The top 2 lines of the LCD are used to indicate *Clock/Calendar* and the status of call progress. The 5 bottom lines of the LCD are associated with the 10 programmable **Feature Access** keys.

A two color LED is also provided to each line key which can be assigned for outside lines, extension lines, Data Transmit and Data Receive, DND or S & R features.

This terminal requires twisted 2 pair cabling to the MDF or the IDF.

#### 26. SINGLE LINE TELEPHONE

Single line telephones can be 2500 type telephones or Dterm IIs and must be locally provided.

Only DTMF single line telephones are compatible with this system.

An MFR-EA ETU, and an RSG-E unit and is either an SLI-EA ETU or an SLI-EB ETU are required for operation of single line telephones.

#### 27. EDE-30-1 DSS/BLF

The EDE-30-1 DSS/BLF is the Direct Station Selection/Busy Lamp Field console that is equipped with 33 programmable non-locking buttons. 30 buttons are used to assign Direct Station Selection (DSS) or such features as *Transfer*, paging, attendant override, *Night Mode* and *Message Waiting*. 3 buttons are for feature use only.

The first 30 buttons are provided with two color LEDs which indicate station status or *Message Waiting* status.

Depressing the button assigned for *Message Waiting* changes the EDE-30-1 DSS/BLF to a *Message Waiting* console.

A maximum of 6 EDE-30-1 *DSS/BLF Consoles* can be installed per system, a maximum of 2 EDE-30-1 *DSS/BLF Consoles* can be associated with any attendant Multiline Terminal.

The EDE-30-1 can also be utilized as a *CO Add-On Module*, the EDE-30-1 must be Revision B or higher. The *CO Add-On Module* can increase the outside line appearances at an *Attendant Position* to the system maximum of forty. The system maximum for EDE-30-1 units remains six, a maximum of four *CO Add-On Modules* can be installed (one per *Attendant Position*). When programming an EDE-30-1 unit as a *CO Add-On Module*, the system must be supported with a CPU-EB-ETU.

#### 28. HFU-E UNIT

The HFU-E UNIT is the *Handsfree* unit that provides the user with *Full Handsfree* operation for both outside and internal calls. It is mounted into the Multiline Terminal.

**NOTE:** The ETE-6-1 TEL cannot be equipped with the HFU-E.

#### 29. DPA-E UNIT

The DPA-E UNIT is the *Dual Path Adaptor Unit* that provides a user with the off-hook announcement feature and is mounted into the Multiline Terminal.

**NOTE:** The ETE-6-1 TEL cannot be equipped with the DPA-E. A Multiline Terminal equipped with a DPA-E must be supported by an ESI-EB ETU.

The *Data Switching* feature has a direct impact on the *Dual Path* features' system maximum and

vice-versa. When a station requires both *Dual Path* and *Data Switching*, it needs the use of three paths (each ESI-EB ETU contains 8 paths utilized by the four ports), therefore removing the second path from the adjacent port. Only ports *one* and *three*, of the ESI-EB ETU, can have both features, while ports *two* and *four* can have either feature (if the adjacent port does not have both).

### 30. DTA-E Unit

The Data Adaptor provides a Multiline Terminal with the capability of asynchronous data switching. A Multiline Terminal equipped with a DTA-E unit can switch data between it and an outside party using a modem; or with an internal station equipped with a DTA-E unit. Speeds of up to 9.6kbps. can be accommodated internally on the RS-232C type interface.

A maximum of one DTA-E unit can be installed per Multiline Terminal, with LCD. The system maximum is 80 units.

**NOTE:** The *Data Switching* feature has a direct impact on the *Dual Path* features' system maximum and vice-versa. When a station requires both Dual Path and Data Switching, it needs the use of three paths (each ESI-EB contains 8 paths utilized by the four ports), therefore, removing the second path from the adjacent port. Only ports *one* and *three*, of the ESI-EB ETU can have both features, while ports *two* and *four* can have either feature (if the adjacent port does not have both).

A CPU-EB ETU and an ESI-EB ETU are required to support this feature.

### 31. ADA-E UNIT

The ADA-E unit is the Ancillary Device Adaptor Unit that allows the Multiline Terminal to connect such locally provided devices as speakerphone, jackset, handset amplifier, etc. and is mounted into the Multiline Terminal.

### 2832. WMU-E

The WMU-E is a universal wall mount unit which can be used to wall mount any Multiline Terminal.

**CHAPTER 2**  
**HARDWARE INSTALLATION**



## CHAPTER 2 TABLE OF CONTENTS

SECTION	DESCRIPTION	PAGE	SECTION	DESCRIPTION	PAGE
<b>210</b>	<b>GENERAL</b>	200-1	<b>240</b>	<b>CENTRAL CONTROL UNITS (CCUs) CONNECTION</b>	
<b>220</b>	<b>SPECIFICATIONS</b>		240.1	Wall Mounting the CCU	200-20
220.1	General Information	200-1	240.2	Floor Mounting the CCU	200-21
220.2	Programming Station	200-1	240.3	General Notes for ETU Installation	200-22
220.3	Attendant Station	200-1	240.4	Common Control ETU's	200-22
220.4	Determination of Equipment Required	200-2	240.5	Basic Interface ETUs	200-23
220.5	Installation Configuration Example	200-5	240.6	Optional Interface ETU's	200-25
220.6	Power Requirements	200-5	240.7	SMDR-E ETU	200-27
220.7	Grounding Requirements	200-5	240.8	LCR-E ETU	200-31
220.8	Electrical Noise Generators	200-7	<b>250</b>	<b>POWER SUPPLY INSTALLATION</b>	
220.9	Additional Equipment	200-7	250.1	PSE-AD-1 PSU	200-32
220.10	System Capacity	200-7	250.2	PSE-DD-1 PSU	200-33
220.11	Cabling Requirements	200-8	250.3	RSG-E Unit	200-34
220.12	Power Requirements	200-8	<b>260</b>	<b>ANCILLARY DEVICE CONNECTION</b>	
220.13	Environmental Conditions	200-9	260.1	General Information	200-34
220.14	Dimensions and Weights	200-9	260.2	Handsfree Unit (HFU-E)	200-35
220.15	Outside Line Type	200-9	260.3	Dual Path Adapter Unit (DPA-E)	200-35
220.16	Network and Control	200-10	260.4	Ancillary Device Adapter Unit (ADA-E)	200-36
220.17	Visual and Audible Indications	200-10	260.5	ADA-E Installation Into a ETE-6-1 Multiline Terminal	200-36
220.18	Dialing Specifications	200-10	260.6	Data Switching Adapter Unit (DTA-E)	200-37
220.19	Battery Backup	200-14	260.7	DTA-E Installation	200-39
220.20	External Equipment Interfacing	200-14	260.8	Wall Mount Unit Installation	200-40
220.21	DTA-E Unit	200-15	<b>270</b>	<b>OPTIONAL EQUIPMENT CONNECTION</b>	
<b>230</b>	<b>SITE PREPARATION AND MDF/IDF CONSTRUCTION</b>		270.1	Music on Hold	200-41
230.1	General Information	200-16	270.2	External Paging	200-41
230.2	Site Survey	200-16	270.3	Background Music	200-42
230.3	Site Limitations	200-16	270.4	External Tone Ringing	200-42
230.4	Site Selection Conditions	200-16	270.5	Night Chime	200-43
230.5	MDF Construction	200-16	270.6	Modem Pooling	200-45
230.6	CCU Cables	200-17			
230.7	Outside Lines	200-17			
230.8	Station Equipment	200-17			



## SECTION 210 GENERAL

This chapter provides a complete and comprehensive understanding of how to properly install each component of the Electra MarkII Digital Telephone System.

It is recommended that this chapter be read in its entirety to familiarize yourself with its content. This will enable a faster, more productive installation and cut-over.

For cut-over of systems, power being supplied to the system should be applied as a final step, just prior to system operational testing (as described in Chapter 5 of this manual).

The Electronic Telephone Units (ETUs) make extensive use of C-MOS technology. **STATIC DISCHARGES TO ANY ETU MUST BE AVOIDED.**

Each interface and optional ETU contains a switch to protect its circuitry from damage during removal and insertion while power is applied to the unit, make it a habit to first ensure this switch (SW1) is **OFF**.

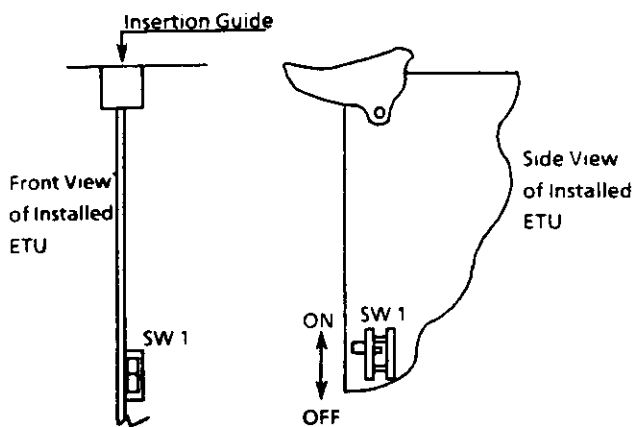

Figure 210-1 SW 1 of ETUs

## SECTION 220 SPECIFICATIONS

### 220.1 GENERAL INFORMATION

Prior to configuring any system, first complete the job specification sheets provided in Section 370 of this manual (and available in the basic CCU as ND-20234) and make sure that all types of station equipment and feature options are taken into account.

An understanding of the system programming is required to properly complete the job specification forms (Refer to Chapter 3).

Even though each CCU has 8 interface slots and 32 ports, all ports are not used for installing station equipment. The installation requirements will dictate the availability of ports for installing station equipment.

This section contains examples that are provided for illustrative purposes only, as well as system specifications.

Twenty five pair cable binders to the MDF should, when possible, pair the same type ETUs together within a cable binder. This will simplify the MDF wiring.

### 220.2 PROGRAMMING STATION

A maximum of 4 programming positions can be available in a system. Station equipment connected to the first three programming positions must be a ETE-16D-1 Multiline Terminal supported by an ESI-EA or ESI-EB ETU; the fourth position can be the RAA - E unit.

The first ESI-E( ) ETU installed in the lowest number module and interface slot is used to provide two programming positions. The first two ports of the ESI-E( ) ETU are assigned for programming positions. These two programming positions are system attendants and are fixed in system software.

**NOTE:** The first port must be associated with an ETE-16D-1 for the system to function properly.

The third programming position can be assigned to any interface port, with an ESI-E( ) ETU installed, by either the first or second programming Multiline Terminal.

### 220.3 ATTENDANT STATIONS

A maximum of 4 attendant positions can be installed in a system. Attendant stations must be ETE-16D-1 Multiline Terminals supported by an ESI-EA or ESI-EB ETU.

The first two attendant positions are the first two programming positions. These two positions are fixed in system software.

The third and fourth attendant positions can only be assigned to the first ESI-E( ) ETU, ports three and four.

An attendant Multiline Terminal can operate in conjunction with up to two EDE-30-1 DSS/BLF consoles and one CO Add-On Module. Each DSS/BLF console and CO Add-On Module requires a port supported by an ESI-EA or ESI-EB ETU.

A maximum of six EDE-30-1 units can be installed per system of which a maximum of four can be assigned as CO Add-On Modules (one per attendant position). No more than six EDE-30-1 units (CO Add-On Module and/or DSS/BLF) can be installed per system.

**220.4 DETERMINATION OF EQUIPMENT REQUIRED**

**1. Station Equipment**

Determine the type and the quantity of each station equipment being installed.

Types of station equipment available are as follows:

- a. ETE-6-1 TEL  
(6 line Multiline Terminal without LCD)
- b. ETE-6D-1 TEL  
(6 line Multiline Terminal with LCD)

- c. ETE-16D-1 TEL  
(16 line Multiline Terminal with LCD)
- d. ETE-16K-1 TEL  
(16 Line Multiline Terminal with directory LCD)
- e. Single Line Telephone without Message Wait Lamp
- f. Single Line Telephone with Message Wait Lamp
- g. EDE-30-1 DSS/BLF console.
- h. EDE-30-1 CO Add-On Module.

**2. Interface ETU**

To determine the quantity of required interface ETUs, refer to Table 220-1.

For your reference, interface slot and port assignment numbers are shown in Figure 220-1.

TABLE 220-2 shows the recommended quantities of MFR-EA ETUs. The actual quantity, for satisfactory service, would vary depending on the amount of single line telephone modem pooling and voice mail traffic.

CCU 3	P	R	O	O	M	O	93	89	85	81	77	73	69	65
	S	S	P	P	M	P	94	90	86	82	78	74	70	66
	U	G	T	T	C	T	95	91	87	83	79	75	71	67
			1	2		3	96	92	88	84	80	76	72	68
CCU 2	P	R	O	O	M	O	61	57	53	49	45	41	37	33
	S	S	P	P	M	P	62	58	54	50	46	42	38	34
	U	G	T	T	C	T	63	59	55	51	47	43	39	35
			1	2		3	64	60	56	52	48	44	40	36
CCU 1	P	R	C	O	T	O	29	25	21	17	13	09	05	01
	S	S	P	P	T	P	30	26	22	18	14	10	06	02
	U	G	U	T	S	T	31	27	23	19	15	11	07	03
				1	W	2	32	28	24	20	16	12	08	04
	POWER SUPPLY AND RSG		COMMON ETUs				8	7	6	5	4	3	2	1

Figure 220-1 Interface Slot and Port Assignment Numbers



Table 220-1 Number of Required Interface ETUs

ETU	CIRCUITS PER ETU	CALCULATION	MAXIMUM ETUs PER SYSTEM
COI-E	4	Divide the number of CO/PBX lines being used by 4. (Note 1)	10 (Note 7)
ESI-EA	4	Divide the number of Multiline Terminals, CO Add-On modules, and DSS/BLF Consoles being used by 4. (Note 2)	20 (Note 4)
ESI-EB	4	Divide the number of Multiline Terminals, CO Add-On modules, and DSS/BLF Consoles being used by 4. (Note 2)	20 (Note 4)
SLI-EA	4	Divide the number of single line telephones and/or modems being used by 4. (Note 3)	18 (Note 4)
SLI-EB	4	Divide the number of single line telephones and/or modems being used by 4. (Note 3)	18 (Note 4)
MFR-EA	2	See TABLE 220-2.	4
CNF-E	1	The number of conference circuits being used.	4
ECR-E	10	When installing external page, chime, and tone ringers, an ECR-E ETU is required.	1
VMI-E	4	When connecting voice mail system, single line telephone, and/or Dictation equipment, VMI-E ETU is required.	1 (Notes 4, 5 & 6)
TLI-E	2	Divided the number of DID and E&M Tie Lines being used by 2. (Note 1)	20 (Note 7)

**Note 1:** If the result is not a whole number, round it up to the next higher whole number.

**Note 2:** A Multiline Terminal, with DPA-E unit (Off-hook Announcement Adaptor) or DTA-E unit (Data Switching Adaptor) installed, requires an ESI-EB ETU, divide the number of those Multiline Terminals installed by 4. If the result is not a whole number, round it up to the next higher whole number. This is the quantity of ESI-EB ETUs required.

If some ports are still available on an ESI-EB, subtract the number of available ports on the ESI-EB ETU from the number of Multiline Terminals being used w/o DPA-E or DTA-E units. Then divide the number by 4. If the result is not a whole number, round it up to the next higher whole number. This is the quantity of ESI-EA ETUs required.

**Note 3:** It is necessary for an SLT with message wait lamp to be supported by an SLI-EB ETU. Divide the number of modems and/or single line telephones with message wait lamp by 4. If the result is not a whole number, round it up to the next higher whole number. This is the quantity of SLI-EB ETUs required.

If some ports are still available on an SLI-EB ETU, subtract the number of available ports on the SLI-EB from the number of single line telephones w/o message wait lamp. Then divide the resulting number by 4. If the result is not a whole number, round it up to the next whole number. This is the quantity of SLI-EA ETUs required.

**Note 4:** Combined total of ESI-EA, ESI-EB, SLI-EA, SLI-EB and VMI-E ETUs cannot exceed 20. (80 stations max.)

**Note 5:** When a voice mail system is connected to the Electra MarkII, MFR-EA ETU(s) may be required, depending on the model of voice mail system.

**Note 6:** When modem pooling and/or a voice mail system is connected to the Electra MarkII, an RSG-E unit is required.

**Note 7:** Combined total of CO/PBX, DID, and E&M Tie lines cannot exceed 40.

**3. Common ETUs.**

- a. CPU-E or CPU-EB ETU must be installed in the CPU slot in the ESE-32B-1 CCU.
- b. TSW-E ETU must be installed in the TSW slot in the ESE-32B-1 CCU.
- c. MMC-E ETU must be installed in the MMC slot in each ESE-32E-1 CCU.
- d. SMDR-E ETU can be installed in any option slot in either ESE-32B-1 or ESE-32E-1 CCUs.
- e. LCR-E ETU can be installed in any option slot in either ESE-32B-1 or ESE-32E-1 CCUs.

**4. CCUs, PSUs, and RSGs**

- a. An ESE-32B-1 CCU is always required
- b. ESE-32E-1 CCU:  
 Divide the total number of interface ETUs by 8. If the result is not a whole number, round it up to the next higher whole number. The whole number minus one is the quantity of ESE-32E-1 CCUs required.

**NOTE:** If total number of interface ETUs is 8 and both SMDR-E and LCR-E ETUs are being installed, an ESE-32E-1 CCU is required.

- c. PSE-AD-1, PSE-DD-1 PSUs:  
 One PSE-AD-1 or PSE-DD-1 PSU is required for each CCU. Combined quantity of ESE-32B-1 CCU and ESE-32E-1 CCU is equal to the total amount of PSUs required.

PSE-AD-1 and PSE-DD-1 PSUs cannot be installed in the same system together.

Table 220-2 Recommended MFR-EA Quantities

QUANTITY OF SINGLE LINE CONNECTIONS	MFR-EA ETUs RECOMMENDED
0	0
1 ~ 20	1
21 ~ 36	2
37 ~ 52	3
53 ~ 72	4

**d. RSG-E Unit:**

An RSG-E unit is required for each (or two adjacent) CCU in which SLI-EA or SLI-EB and VMI-E ETUs are being installed.

Table 220-3 Recommended RSG-E Quantities

QUANTITY OF SINGLE LINE CONNECTIONS	RSG-E UNITS RECOMMENDED
0	0
1 ~ 24	1
25 ~ 48	2
49 ~ 72	3

**5. Optional Equipment**

Table 220-4 shows the optional equipment that can be mounted into Multiline Terminals. When a DPA-E, DTA-E or both are mounted into a Multiline Terminal, the Multiline Terminal must be supported by an ESI-EB ETU.

Table 220-4 Optional Equipment

OPTIONAL EQUIPMENT	MULTILINE TERMINAL			
	ETE-6-1	ETE-6D-1	ETE-16D-1	ETE-16K-1
HFU-E UNIT	NC	●	●	●
DPA-E UNIT (NOTE)	NC	●	●	●
ADA-E UNIT	C	●	●	●
DTA-E UNIT (NOTE)	NC	●	●	●

● = Compatible with other options simultaneously

NC = Not connectable

C = Connectable

**NOTE:** Requires terminal to be supported by an ESI-EB ETU.

## 220.5 INSTALLATION CONFIGURATION EXAMPLE

An example is provided in Table 220-5 to help in understanding some of the requirements when configuring a system. In this example, 12 CO lines, 12 Multiline Terminals without optional equipment, 5 Multiline Terminals with DPA-E units, 3 Multiline Terminals with DTA-E units, 2 Multiline Terminals with both a DTA-E and DPA-E unit, 10 SLTs without message wait lamp, 6 SLTs with message wait lamp, 3 external speakers for zone paging, 6 handsfree units, 4 ADA-E units, 2 conference circuits, 4 Tie Lines, 3 DSS/BLF consoles, 1 CO Add-On Module, LCR, and SMDR are being installed. The equipment required to support this configuration is shown in Table 220-5. Refer to Figure 220-2 to help in the conceptual understanding of the system.

## 220.6 POWER REQUIREMENTS

a. When AC power is to be used to power the system, a PSE-AD-1 PSU must be installed in each CCU.

The system must have a dedicated grounded 117VAC  $\pm 10\%$  outlet separately fused for 4, 8, or 12 AMPS (depending on CCU requirements). (See paragraph 220.12).

The AC outlet must be a standard 125 Volt 15 Amp three-prong type which provides conduit ground. If conduit ground is not available, a locally provided frame ground to earth ground connection must be provided. (See paragraph 220.7).

The AC power must be within the limits given in paragraph 220.12 (Power Requirements) in this section.

It is recommended that the best locally available AC surge protection be installed at the AC power outlet.

b. When DC power is to be used to power the system, a PSE-DD-1 PSU must be installed in each CCU. A locally provided -48VDC power source must be connected to the PSE-DD-1 PSUs.

A local frame ground, to earth ground, connection must be provided, as described in paragraph 220.7. The -48VDC power source must operate within the limits provided in paragraph 220.12.

## 220.7 GROUNDING REQUIREMENTS

The CCUs must be properly grounded. If conduit ground is not available at the dedicated AC

outlet, the following steps should be taken:

1. Provide a suitable water pipe ground in accordance with the local operating telephone company procedures.
2. If no water pipe ground is available, a ground rod should be installed in accordance with the local operating telephone company procedures.
3. Where a ground other than conduit ground is used, a grounding terminal is provided on the ESE-32B-1 CCU as shown in Figure 220-3.

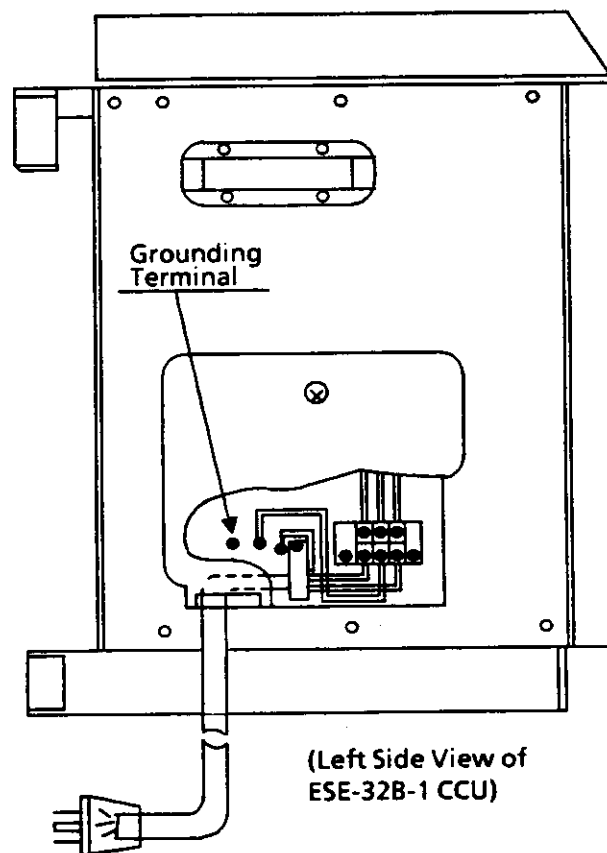

Figure 220-3 CCU Grounding

4. Grounding Requirements for Modem Pooling. The RS-232C is susceptible to noise and static, and requires proper grounding to protect any DTA-E unit and DTE connected to it.

Normally, a DTE with RS-232C interface has its frame ground connected to earth ground. Therefore, ensure that the DTEs connected to DTA-E units are properly connected to earth ground via conduit ground of its AC power cord.

Table 220-5 System Configuration Example

DEVICE TYPE	SYSTEM EQUIPMENT QUANTITY	REQUIRED UNITS AND QUANTITY	SLOT POSITION	REMARKS
Central Control Unit	1	ESE-32B-1		
	2	ESE-32E-1		
Power Supply	3	PSE-AD-1	PSU	
Ring Generator	1	RSG-E	RSG	NOTE 1
CO Line	12	3 COI-E	3 interface slots	
Tie Line	4	2 TLI-E	2 interface slots	
Multiline Terminals with DPA-E installed	5	3 ESI-EB	7 interface slots	ETE-6-1 TEL cannot be equipped with DPA-E, HFU-E or DTA-E Units.
Multiline Terminals with DTA-E installed	3			
Multiline Terminals with DTA-E and DPA-E installed	2			
Multiline Terminals without DPA-E installed	12	4 ESI-EA		
DSS/BLF consoles, CO Add-On Modules	4			
Single line telephones with message wait lamp	6	2 SLI-EB	4 interface slots	NOTE 2
Single line telephones without message wait lamp	10	2 SLI-EA		
DTMF Receiver Unit	1	1 MFR-EA	1 interface slot	
Conference Circuits	2	2 CNF-E	2 interface slots	
External Speakers	3	ECR-E	1 interface slot	NOTE 3
Station Message Detail Recording	1	SMDR-E	1 option slot	
Least Cost Routing	1	LCR-E	1 option slot	
Off-Hook Announcement	7	7 DPA-E		Mounted into Multiline Terminal
Data Switching	5	5 DTA-E		Mounted into Multiline Terminal
Handsfree Unit	6	6 HFU-E		Mounted into Multiline Terminal
Ancillary Device Adapter	4	4 ADA-E		Mounted into Multiline Terminal

- NOTE 1: Install the RSG-E unit in the CCU where all SLI-E( ) ETUs are installed, or use supplementary RSG cable.
- NOTE 2: Install all SLI-E( ) ETUs in one CCU only, if not, then in two adjacent CCUs.
- NOTE 3: External speakers and amplifiers for paging must be locally provided.

The same care should apply to a modem connected to the DTA-E unit.

If a modem to be connected is not provided with a three-prong type cord supporting conduit ground, the modem must be properly connected to earth ground.

### 220.8 ELECTRICAL NOISE GENERATORS

Certain equipment, such as welding machines, thyristor-driven power supplies, large electric motors, etc., generate electrical noise. As a stored program machine, the Electra MarkII system is vulnerable to this noise. When this type of machinery is present at an installation, the following precautionary steps are urged:

1. Locate the CCUs, telephone sets and cabling away from these machines.
2. If cables must pass near these machines, use shielded cable with the shield grounded.

3. Ensure all machines of this type are well grounded to a separate ground to minimize noise interference.

### 220.9 ADDITIONAL EQUIPMENT

In addition to electronic station equipment, the CCUs and their components, other equipment is required. This includes cables, modular connecting jacks, quick-connect blocks or similar equipment, etc. This additional equipment must be locally supplied.

### 220.10 SYSTEM CAPACITY

1. Electra MarkII capacities are as follows:
  - a. System ports: 96 ports max.
  - b. Outside lines: 40 lines max.
  - c. Intercom paths: Non blocking
  - d. Station sets: 80 sets max.

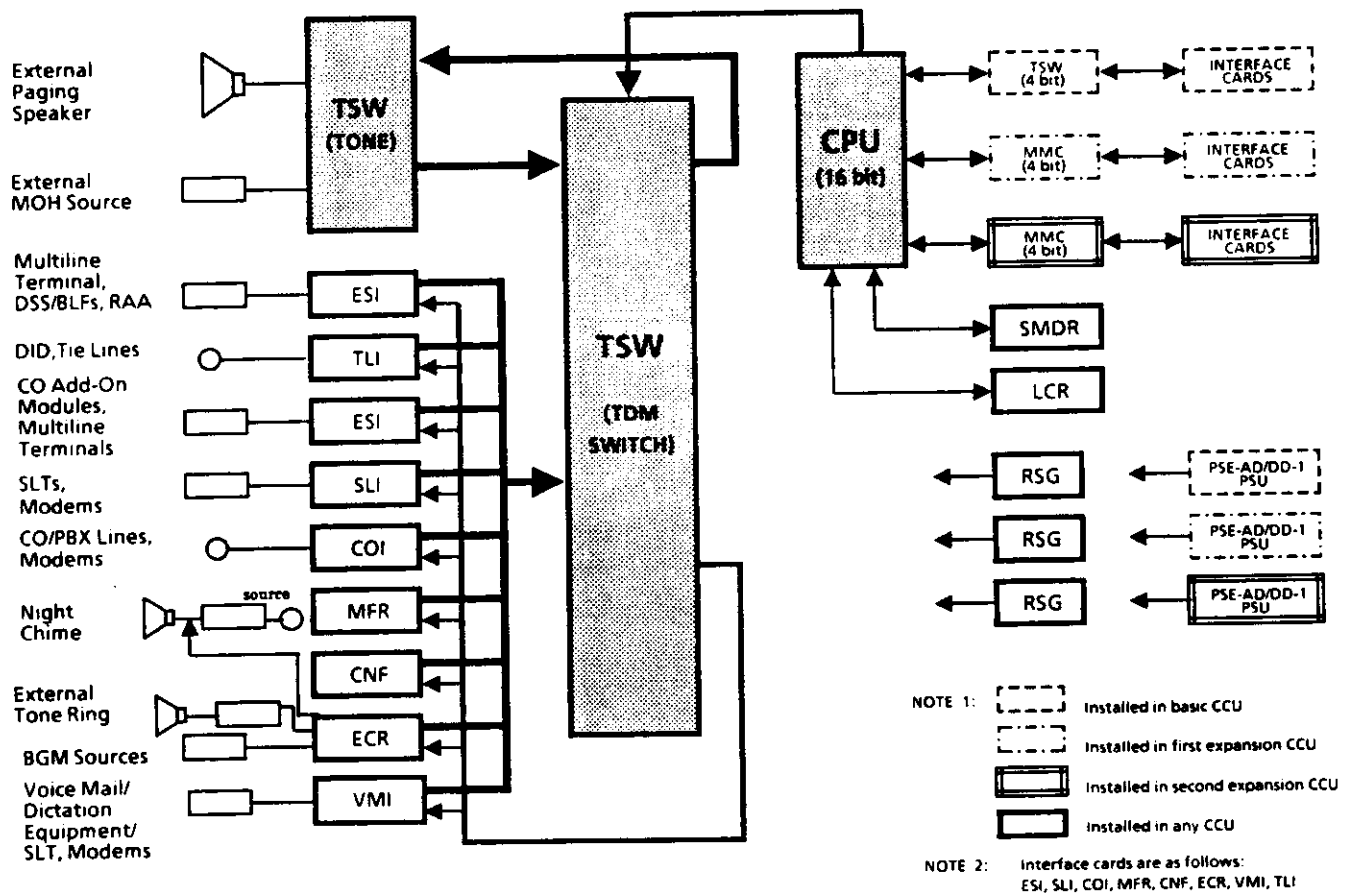

Figure 220-2 System Block Diagram

- e. DSS/BLF consoles: 6 units max.; of the total of six, a max. of 4 units can be CO Add-On Modules.
- f. System speed dial: 80 buffers (16 digits each).
- g. Station speed dial: 20 buffers each station (16 digits each) (110 buffers for the ETE-16K-1).
- h. Conference circuits: 4 max.
- i. Modem Pool: 4 modems max.

**NOTE:** These figures represent the maximum number of individual type devices installed. Since the system capacity is defined by 96 ports, some devices may not be installed up to their maximum numbers depending upon the system configuration.

2. The central equipment of this telephone system consists of up to three Central Control Units (CCUs).

- a. Basic CCU: 32 ports.
- b. Basic CCU + One Expansion CCU: 64 ports.
- c. Basic CCU + Two Expansion CCUs: 96 ports.

3. A maximum of two DSS/BLF consoles and one CO Add-On Module can be equipped at any attendant position.

4. Combination of system speed dial memory numbers and any number can be assigned to station speed dial (Consecutive Speed Dial Memory Assignment). By using this technique, more than a sixteen digit number can be available for speed dialing.

#### 220.11 CABLING REQUIREMENTS

Each CCU is equipped with three 50 position miniature ribbon type (female) amphenol connectors. 50 position miniature ribbon type connector (male) ended cables are required for connections to the Main Distribution Frame (MDF).

Allowable loop resistance, length, and type of cable are as follows:

1. Maximum Loop Resistance and Cable Length, using 24 AWG

- a. ETE-6-1: 80 ohms/1,500 feet (450m)
- b. ETE-6D-1: 65 ohms/1,300 feet (400m)
- c. ETE-16D-1w/BLF: 40 ohms /820 feet (250m)
- d. ETE-16D-1w/o BLF: 55 ohms/1000 feet (300m)
- e. ETE-16K-1: 55 ohms/1,000 feet (300m)
- f. RAA-E Unit: 55 ohms/1000 feet (300m)
- g. DSS/BLF console: 55 ohms/1,000 feet (300m)
- h. CO Add-On Module: 55ohms/1000 feet (300m)
- i. Single line telephone: 600 ohms (including instrument)

#### 2. Cable Type

- a. Multiline Terminal: Twisted 2 pair
- b. Single line telephone: Twisted pair
- c. DSS/BLF Console: Twisted 2 pair
- d. CO Add-On Module: Twisted 2 pair
- e. RAA-E unit: Twisted 2 pair
- f. Music Source: Hi-Fi type shielded audio cable
- g. External amplifier: Hi-Fi type shielded audio cable
- h. Modem cable: RS-232C cable with jacks on both ends (Special Null-modem cable).

#### 220.12 POWER REQUIREMENTS

##### 1. AC Input (PSE-AD-1)

- a. 117 V AC  $\pm$  10% 60 Hz  $\pm$  10%, single phase
- b. A dedicated outlet, separately fused and grounded, is required

##### 2. DC Input (PSE-DD-1)

-40VDC ~ -56VDC

3. Power Consumption (PSE-AD-1 and PSE-DD-1)

Table 220-6

MODULES	CURRENT DRAW	POWER DISSIPATION
1	4A	1,600 BTUs/hr
2	8A	3,200 BTUs/hr
3	12A	4,800 BTUs/hr

NOTE: When PSE-DD-1 PSUs are installed, power dissipation of the locally provided -48VDC power source and batteries should also be taken into account.

4. Power Supply Outputs (PSE-AD-1 and PSE-DD-1)

Table 220-7 Power Supply Outputs

DC VOLTAGE	MAXIMUM CURRENT
-24V ± 2V	4.5A
-5V ± 0.25V	1.2A
+5V ± 0.25V	8.0A

5. RSG-E Unit

- a. Output voltage: 70 ~ 120 V RMS
- b. Output frequency: 17 ~ 23 Hz
- c. Output power: 4.1 VA

6. Fuse Replacement

When a fuse is blown, refer to Table 220-8 for fuse replacement specifications.

220.13 ENVIRONMENTAL CONDITION

1. Temperature

- a. Operating: 32°F ~ 104°F (0°C ~ 40°C)
- b. Recommended long term: 50°F ~ 90°F (10°C ~ 32.2°C)

2. Humidity

Operating: 10% ~ 90% relative, non-condensing

220.14 DIMENSIONS AND WEIGHTS

Table 220-9

	SHIPPING WEIGHT (kg)	HEIGHT (mm)	WIDTH (mm)	DEPTH (mm)
ESE-32B-1	43 lbs. (19.6)	14 3/4" (375)	25 9/16" (640)	12 5/8" (320)
ESE-32E-1	26 lbs. (11.8)	11 13/16" (300)	25 9/16" (640)	12 5/8" (320)
PSE-AD-1	4 lbs. (1.7)	8 3/32" (206)	3 15/16" (100)	9 1/16" (230)
PSE-DD-1	4 lbs. (1.7)	8 3/32" (206)	3 15/16" (100)	9 1/16" (230)
RSG-E	5 lbs. (2.4)	8 3/32" (206)	2 5/32" (55)	9 1/16" (230)
RAA-E	2.51 lbs. (1.1)	2 5/32" (55)	3 15/16" (100)	7 7/8" (200)
ETE-6-1	2 lbs. (0.9)	3 5/16" (84)	6 7/32" (158)	8 7/8" (225)
ETE-6D-1	3 lbs. (1.2)	3 5/16" (84)	8 5/32" (207)	8 7/8" (225)
ETE-16D-1	3 lbs. (1.2)	3 5/16" (84)	8 5/32" (207)	8 7/8" (225)
ETE-16K-1	3 lbs. (1.3)	3 5/16" (84)	10 3/8" (263.5)	8 7/8" (225)
EDE-30-1	1 lb. (0.4)	3 5/16" (84)	3 5/8" (98)	8 7/8" (225)

220.15 OUTSIDE LINE TYPE

- a. Two wire, loop start lines
- b. Two wire, ground start trunks
- c. Two wire, loop dial DID pulse lines
- d. Two wire, E&M Tie lines (type 1 or 5, Dial Pulse)
- e. Four wire, E&M Tie lines (type 1 or 5, Dial Pulse)

Table 220-8 Fuse Replacement

UNIT	FUSE #	SPECIFICATION	DESCRIPTION	DIMENSIONS
PSE-AD-1	F1	125V, 6.3A	AC INPUT	1/4" x 1 1/4"
PSE-DD-1	F1	125V, 8.0A	DC INPUT (-48V)	1/4" x 1 1/4"
RSG-E	F1	250V, 0.5A	DC INPUT (-24V)	13/64" x 45/64" (5mm x 20mm)

NOTE: All fuses used are normal blown glass tube or ceramic type. Do not use slow blow fuses.

**220.16 NETWORK AND CONTROL**

1. Control
  - a. Control: Stored program with distributed processing
  - b. Central Processor: 16 bit microprocessor
  - c. Clock: 8 MHz
  - d. Module Processor (TSW-E & MMC-E): 4 bit one chip microprocessor
  - e. Interface card (COI-E, ESI-E( ), etc.): 4 bit one chip microprocessor
  - f. Multiline Terminal: 4 bit one chip microcomputer
  - g. DSS/BLF Console: 4 bit one chip microcomputer
  - h. Directory Multiline Terminal: 4 bit one chip microcomputer
  - i. Remote Administration Adaptor: 8 bit microcomputer

2. Transmission

- a. Data length:  
 From Multiline Terminal to ESI-E( ): 32 bits  
 From ESI-E( ) to Multiline Terminal: 32 bits
- b. Data transmission rates:  
 Between ESI-E( ) and Multiline Terminal:  
 256k bits/sec
- c. Data transmission pairs:  
 To Multiline Terminals and EDE-30-1: 2 pair data
- d. Scanning time for each Multiline Terminal: 32 mS

3. Network

TDM switching	PCM ( $\mu$ Law)
TDM clock	2.048 MHz
TDM slot period	488.28 nS
TDM data bus	8 bit
TDM time frame	125 $\mu$ S

4. Telephones

- a. Multiline Terminal and DSS/BLF console:  
 Voltage: -11 ~ -26VDC  
 Max. current: 200 mA

Acoustic characteristics meet Electronic Industry Association (EIA) standard proposal SP-1286 and standard EIA RS-470.

- b. Single line telephone  
 Standard 2500 set: 500 network  
 Nominal current: 35 mA  
 Ring signal: 65 VAC RMS 20 Hz

Dterm II:

- Nominal current: 20mA  
 Ring signal: 50V AC RMS, 16Hz  
 Lamp signal: 53 ~ 88VDC

**220.17 VISUAL AND AUDIBLE INDICATIONS**

1. Visual Indications  
 LED indications on a Multiline Terminal and CO Add-On module shown in Table 220-10.
2. Audible Indications  
 Audible indications from a Multiline Terminal shown in Table 220-11.
3. EDE-30-1 Visual Indications  
 LED indications on a EDE-30-1 console shown in Table 220-12.

**220.18 DIALING SPECIFICATIONS**

1. Dial Pulse Address Signaling
  - a. Pulse rate: 10 pps/20 pps
  - b. Percent break:  $61 \pm 3$  percent
  - c. Interdigital interval: nominal 700 mS
2. DTMF Address Signaling
  - a. Frequencies

Two sinusoidal signals, one from a high group of three frequencies and one from a low group of four frequencies.

Table 220-13

		Nominal High Group Frequencies (Hz)		
		1209	1336	1447
Nominal Low Group Frequencies (Hz)	697	1	2	3
	770	4	5	6
	852	7	8	9
	941	*	0	#



Table 220-10 LED Flash Patterns

LED	CONDITION	FLASH PATTERNS
Outside * Extension Line	I-Use	————— Green
	Busy	————— Red
	Incoming Call	———      ——— Red      ———
	I-Hold	- - -      - - - Green      - - -
	Call Hold	———      ——— Red      ———
	Recall	- - -      - - - Green      - - -
Microphone	ON (While being voice paged)	————— Red
Speaker	ON (Monitor or handsfree)	————— Red
Conference	Conference in progress	————— Red
	Establishing conference	———      ——— Red      ———
	User Programming	- - -      - - - Red      - - -
Answer	Brokers call	————— Red
	Incoming call, Camp-On Override, Recall	———      ——— Red      ———
Do Not Disturb	ON (DND set) (Note 2)	————— Red
Save & Repeat	ON (Saved) (Note 2)	————— Red
DT or DR	Request for modem; DTE turned off or waiting for modem connection	————— Red
	Request for modem; DTE turned on	———      ——— Red      ———
	Modem connection established	————— Green
	Request for modem; all modems busy or distant end modem disconnected first from modem call.	- - -      - - - Red      - - -

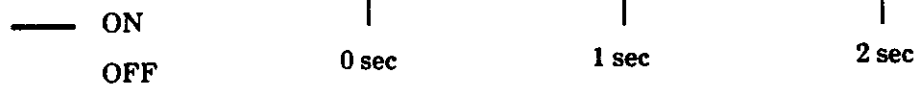

**NOTE 1:** Green LED indications are not provided for MIC, SPKR, CNF and ANS keys on Multiline Terminals, nor for outside line buttons on ETE-6-1 Multiline Terminals'. (Therefore, red LEDs will light in place of green LEDs on the ETE-6-1 Multiline Terminals).

**NOTE 2:** DND and Save & Repeat functions may be assigned on line buttons.

\* Applies to CO Add-On module as well as Multiline Terminal.

Table 220-11 Tone Patterns

NO.	TONE	FREQUENCY (Hz)	FLASH PATTERNS
1	Dial Tone	350/440	
2	<ul style="list-style-type: none"> <li>• Second Dial Tone</li> <li>• LCR Dial Tone</li> </ul>	350/440	
3	Busy Tone	480/620	
4	Call Waiting Tone	440	
5	Ringback Tone	440/620	
6	Reorder Tone	480/620	
7	<ul style="list-style-type: none"> <li>• Voice Page Alert Tone</li> <li>• Attendant/ Tone Override</li> <li>• Camp-On Tone</li> </ul>	440	
8	<ul style="list-style-type: none"> <li>• Call Forward Alert Tone</li> <li>• Call Forward Confirmation Tone</li> </ul>	350/440	
9	Confirmation Tone	440	
10	Error Tone Burst	620	
11	Recall Tone	1024	
12	CO/PBX Ring Tone	480/606	
13	Internal Ring Tone	480/606	
14	Boss/Secretary Ring Tone	480/606	

Table 220-12 DSS/BLF Visual Indications

LED	STATUS		FLASH PATTERNS
DSS KEY	Station	Busy	————— Green
	Primary Ext.	Idle or I-Use	
	Station	Idle or Busy	————— Red
	Primary Ext.	Incoming Call or Recall	
	Station	Idle or Busy	— — — — — Red (Flashing)
	Primary Ext.	Other Use	
	Do Not Disturb		— — — — — Red (Winking)
Off Line and Lockout		————— Red (Flashing)	
Internal and External Paging	In Use		————— Red
Message Waiting	Message Mode		————— Red
Night Transfer	Night Mode		————— Red
——— ON OFF			 0 sec               1 sec               2 sec

NOTE 1: Steadily Lit Red LED - Attendant cannot override  
 Flashing Red LED - Attendant cannot override  
 Winking Red LED - Attendant can override  
 Steadily lit Green LED - Attendant can override  
 LED OFF - Attendant can call

NOTE 2: LED indications on DSS keys are the same regardless of dual path, but what attendant can do may be different.

NOTE 3: On the Multiline Terminals with built-in BLF, LED flash patterns are same as the ones on the DSS/BLF console, but green LED indication is not provided.

- b. Frequency deviation: Less than  $\pm 1.5\%$
- c. Signal level:
  - Nominal level per frequency:  
-6 ~ -4dBm
  - Minimum level per frequency:
    - Low group: -10 dBm
    - High group: -8 dBm
  - Maximum level per frequency pair: +2 dBm

- d. Rise time: Within 5 mS
- e. DTMF tone duration:
  - Default: 110 mS.
  - Minimum: 60 mS.
  - Maximum: 760 mS.
- f. Interdigital time:
  - Default: 70 mS.
  - Minimum: 40 mS.
  - Maximum: 180 mS.

### 3. Dialing Memories

- a. Station speed dialing:
  - 20 buffers (16 digits each) per station
  - 110 buffers (16 digits each) per ETE-16K-1
- b. System speed dialing:
  - 80 buffers (16 digits each) per system
- c. Last number redial:
  - 1 per station (16 digits max.)
- d. Saved number dialing: (Save & Repeat)
  - 80 per system (16 digits max.)

### 220.19 BATTERY BACKUP

1. Backup battery power is provided on the CPU-E ( ), the SMDR-E, and the LCR-E ETU. These batteries, when fully charged, retain memory contents for approximately 7 days when power is removed from these ETUs.

2. Functions receiving backup with battery power are as follows:

- a. System Program
- b. Speed Dial Memories (System and Station)

- c. Night Transfer Status
- d. Call Forwarding
- e. Clock/Calendar
- f. Callback Request
- g. Message Waiting
- h. Do Not Disturb
- i. Save & Repeat
- j. SMDR Data
- k. LCR Data

### 220.20 EXTERNAL EQUIPMENT INTERFACING

#### 1. Music on Hold (MOH)

- a. Auxiliary input: 0.6 V RMS signal level
- b. Input impedance: 10k ohms

#### 2. SMDR Output

Female connector (System output), Standard RS-232C

#### 3. External Paging (Audio)

- a. Output power: -10.0 dBm signal level
- b. Output impedance: 600 ohms

#### 4. BGM Input

- a. Auxiliary input: 0.1V RMS signal level
- b. Input impedance: 50k ohms

#### 5. External Paging Contacts

Contact rating: 500 mA, 24V DC

#### 6. Hookswitch contacts:

Contact rating: 100 mA, 48V DC

**NOTE: Do Not Send AC Signal Through Hookswitch Contacts.**

#### 7. External Tone Ringer Output

- a. Output Level: 0.1V peak to peak ~ 1.0V peak to peak
- b. Output Impedance: 600 ohms
- c. Relay Contact Rating: 500mA, 24V DC

8. Night Chime  
Relay Contact Rating: 500mA, 24V DC

9. DTA-E  
Relay Contact Rating: 24VDC: 1A  
120VAC: 0.5A

### 220.21 DTA-E

The DTA-E unit is provided with an RS-232C for interfacing with Data Terminal Equipment (DTE). Prior to configuring a system with data capability, you should complete the job specification sheets provided with this manual (available in the ESE-32B-1 CCU as document number ND-20234).

An understanding of system programming is required to complete the job specification sheets (See Chapter 3, Programming).

This section contains specifications for the DTA-E unit and precautions that must be followed when installing the DTA-E unit.

#### 1. Interface

The DTA-E unit is equipped with a female RS-232C connector to support the RS-232C interface. For internal data communication, speeds of up to 9.6 kbps can be accommodated by the RS-232C interface.

For connecting the interface unit, a 25 pin RS-232C connector is provided with the following configuration:

Table 220-13 DTA-E RS-232C Connector Pin Configuration

PIN #	SIGNAL FLOW	DESCRIPTION
1		Frame Ground (FG)
2	DTE → DCE	Transmit Data (TXD)
3	DTE ← DCE	Receive Data (RXD)
4	DTE → DCE	Request to Send (RTS)
5	DTE ← DCE	Clear to Send (CTS)
6	DTE ← DCE	Data Set Ready (DSR)
7		Signal Ground (SG)
8	DTE ← DCE	Data Channel Carrier Detect (DCD)
20	DTE → DCE	Data Terminal Ready (DTR)
22	DTE ← DCE	Ring Indicator (RI)

**Note:** Either full duplex or half duplex can be accommodated with the RS-232C interface.

#### 2. Power Requirements

The DTA-E unit is provided with an AC/DC power supply adaptor as an attachment. Specifications for this AC/DC adaptor are as follows:

- AC Input:  
120V AC, 60 Hz, single phase

- DC Output

NOMINAL DC VOLTAGE	DC VOLTAGE TOLERANCE	CURRENT	USE
+12V	11.4V ± 0.3V	210 mA	RS-232C Line Drive
-12V	12.6V ± 0.3V	80 mA	RS-232C Line Drive
+12V	12.4V ± 0.3V	65mA	DTA-E Circuit

#### 3. Grounding Requirements

Proper grounding is required to protect the DTA-E unit and the data terminal equipment connected to the DTA-E unit. Usually, data terminal equipment with an RS-232C interface has its frame connected to earth ground. Ensure that data terminals connected to the DTA-E units are properly connected to earth ground via conduit ground of the AC power cord used in the data terminals.

#### 4. Cabling Requirements

For connecting of data terminal equipment to the DTA-E unit, a locally provided RS-232C straight cable with a male connector at each end must be obtained. Cable specification is as follows:

Length: 50 feet (15m)  
Type: Twisted pair  
Shielded RS-232C straight cable with two RS-232C male connectors

RS-232C	
7 ●	SG
2 ●	TXD
3 ●	RXD
4 ●	RTS
5 ●	CTS
6 ●	DSR
8 ●	DCD
20 ●	DTR
22 ●	RI

**NOTE:** Other pins are not connected

Figure 220-3 RS-232C Straight Cable Pin Connections

## SECTION 230 SITE PREPARATIONS and MDF / IDF CONSTRUCTION

### 230.1 GENERAL INFORMATION

This section presents a survey of the planning details that should be considered prior to installing an ELECTRA MARK II system. Detailed planning in advance of the actual installation will help ensure that minimum time and cost are incurred and, concurrently, will cause a minimum disruption of the customer's business activities. Additional benefits of a well planned and executed installation include flexibility for changes and expansion at minimum cost, efficient maintenance, and increased customer satisfaction.

### 230.2 SITE SURVEY

In most cases, a survey of a customer's premises is needed to develop a cost estimate for the installation. This preliminary data should be used in the site selection of the Main Distribution Frame (MDF). A second visit to the job site may be necessary to obtain exact dimensions of the area selected for the MDF, cable lengths, and possible IDF locations. This information will provide the basis for planning an orderly and efficient installation.

For example, the collected data about the job site will generally permit the MDF to be partially preassembled at the installer's shop, thereby helping to minimize the time spent at the customer's premises.

Preassembling the MDF and IDF, would be especially advantageous for those cases where the MDF or IDF, must be placed in an area that is awkward for this type of work.

### 230.3 SITE LIMITATIONS

Installation of a telephone system is seldom a straightforward routine procedure. The uniqueness of each customer's situation requires a tailored approach to each job. In selecting a permanent site for the MDF, the installer may encounter problems such as the following:

- Limited space is available and must be used, regardless of its suitability.
- The available space may be adequate but may pose one or more environmental hazards.

- The proposed location has limitations, such as, insufficient lighting, or the lack of a suitable ground, for grounding the CCUs.

Whatever the nature of the adversities encountered, the installer must make the necessary decisions to arrive at the best possible solutions for both the customer and the equipment being installed. It is beyond the scope of this manual to cover all possible situations with specific solutions. The following are general guidelines, precautions and necessities, which should be observed when making the decisions for installation.

It should be noted that there are certain specific requirements and precautions which, if not followed, will impair the reliability of the system.

### 230.4 SITE SELECTION CONDITIONS

The following conditions should be met at the site chosen for mounting the Central Control Unit (CCU).

- A. The CCU is normally wall mounted, to protect against accident or flooding. Use of a 3/4" plywood backboard is recommended for this purpose.
- B. The CCU should not be located directly beneath pipes, due to the possibility of leaks or condensation causing damage to the ELECTRA MARKII equipment.
- C. The area in which the CCU is to be located must be free of corrosive and inflammable gases, excessive chemical or industrial dusts, and other materials which could cause a hazard to personnel or to the proper functioning of the equipment.
- D. Heat and humidity must be within the limits provided in Section 220, of this manual.

E. Although its virtually noiseless operation allows a wide selection of installation sites, care should be taken that CCU(s) do not present a hazard to office traffic. For purposes of economy, a central location to minimize cabling, is often used.

### 230.5 MDF CONSTRUCTION

The Main Distribution Frame (MDF) consists of two different types of standard quick-connect terminal blocks, which are to be mounted onto the 3/4" plywood

backboard. For the sake of neatness and ease of access, it is also recommended that the blocks be mounted on appropriate standoffs. The recommended blocks are; the 66B50 type, for termination of the CCU J cables, and the 66M50 type, for termination of the station cables.

The Intermediate Distribution Frame (IDF) requires only the 66M50 type blocks.

Both the MDF and the IDF utilize standard bridging clips for each type terminal block. The bridging clips are used to mate the left half of the terminal block (terminated cable run) to the right half of the terminal block (cross connection wire). The bridging clips are also useful during trouble shooting to help isolate the cable runs and telephones from the central equipment and the Central Office Network from the system.

Refer to Figure 230-1 for a suggested MDF layout.

### 230.6 CCU CABLES

Each CCU comes equipped with three 50 pin, female amphenol type connectors. These connectors are designated J1 to J3. Since each CCU uses the same designations for the J connectors, it is recommended that the MDF terminal blocks be labeled with the CCU number as well as the connector number; for example: 1J1, 2J1, 3J1, 1J2, etc.

Refer to section 240, of this manual, for CCU wall mounting.

### 230.7 OUTSIDE LINES

A. The FCC authorized connector for the connection of CO lines is an RJ21X. The CO lines will be connected in sequence within this termination block, therefore, the lines must be ordered in the appearance order best suited to the customer's usage.

B. Table 230-1 provides complete information about the 50 position connector, showing pin number, lead function, running cable color, and circuit designation.

C. Ground start and/or Loop start, Loop dial DID, 2 and 4 wire loop dial E&M Tie lines, type 1 and 5, can be connected to this system. It is recommended that only twisted pair wiring be used to cross connect the lines from the RJ21X termination block to the MDF.

Refer to Table 230-1 for proper connection identification.

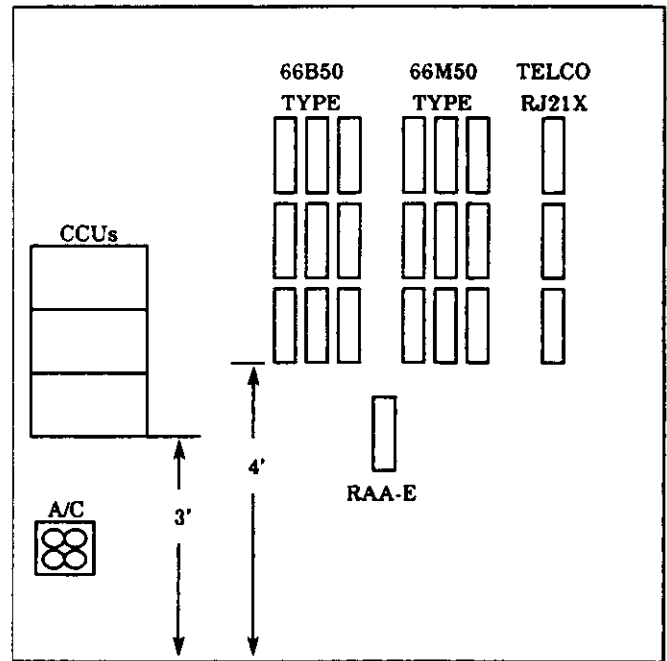

Figure 230-1 Typical MDF Layout

D. **HALF-TAPPING** or **PARALLEL CONNECTIONS** must not be used on outside lines connected to the Electra MarkII telephone system. This practice generally results in system malfunctions on the outside lines.

E. Table 230-1 includes termination of PT and PR designations, for the Power Failure Transfer feature. Any time a power failure or brownout occurs in the system, central office Tip and Ring will be present at these terminals. Cross connection between a CO tip (T) and ring (R) and an SLI-EB ETUs PT and PR, provides power failure transfer to a Single Line Telephone installed within the system.

### 230.8 STATION EQUIPMENT

A. When connecting Multiline Terminals, DSS/BLF consoles or CO Add-On Modules to the MDF or IDF, individually twisted two pair cabling must be used.

Refer to section 220, of this manual, for specifications, Table 230-1, for lead identifications and Figure 230-3, for station modular jack (RJ11C/W) connection.

Table 230-1 J1 ~ J3 Connection Information / J Connector and Port Relationship

PIN	RUNNING CABLE	STATION CABLE	LEAD FUNCTIONS						J1	J2	J3
			KEY TEL	SLT/VMI	LOOP DIAL DID	2 WIRE E&M TIE LINE	4 WIRE E&M TIE LINE	ECR			
26 1 27 2	WH-BL BL-WH WH-OR OR-WH	GN RD BK YL	TA RA TB RB	T R PT PR	T R	T R E M		1A 1B 2A 2B	PORT 01 "33" (65)	PORT 13 "45" (77)	PORT 25 "57" (89)
28 3 29 4	WH-GN GN-WH WH-BR BR-WH	GN RD BK YL	TA RA TB RB	T R PT PR	T R	T R E M		3A 3B 4A 4B	PORT 02 "34" (66)	PORT 14 "46" (78)	PORT 26 "58" (90)
30 5 31 6	WH-SL SL-WH RD-BL BL-RD	GN RD BK YL	TA RA TB RB	T R PT PR	T R	N/C	T R T1 R1	5A 5B 6A 6B	PORT 03 "35" (67)	PORT 15 "47" (79)	PORT 27 "59" (91)
32 7 33 8	RD-OR OR-RD RD-GN GN-RD	GN RD BK YL	TA RA TB RB	T R PT PR	T R	N/C	T R T1 R1	N/C	PORT 04 "36" (68)	PORT 16 "48" (80)	PORT 28 "60" (92)
34 9 35 10	RD-BR BR-RD RD-SL SL-RD	GN RD BK YL	TA RA TB RB	T R PT PR	T R	T R E M		1A 1B 2A 2B	PORT 05 "37" (69)	PORT 17 "49" (81)	PORT 29 "61" (93)
36 11 37 12	BK-BL BL-BK BK-OR OR-BK	GN RD BK YL	TA RA TB RB	T R PT PR	T R	T R E M		3A 3B 4A 4B	PORT 06 "38" (70)	PORT 18 "50" (82)	PORT 30 "62" (94)
38 13 39 14	BK-GN GN-BK BK-BR BR-BK	GN RD BK YL	TA RA TB RB	T R PT PR	T R	N/C	T R T1 R1	5A 5B 6A 6B	PORT 07 "39" (71)	PORT 19 "51" (83)	PORT 31 "63" (95)
40 15 41 16	BK-SL SL-BK YL-BL BL-YL	GN RD BK YL	TA RA TB RB	T R PT PR	T R	N/C	T R T1 R1	N/C	PORT 08 "40" (72)	PORT 20 "52" (84)	PORT 32 "64" (96)
42 17 43 18	YL-OR OR-YL YL-GN GN-YL	GN RD BK YL	TA RA TB RB	T R PT PR	T R	T R E M		1A 1B 2A 2B	PORT 09 "41" (73)	PORT 21 "53" (85)	N/C
44 19 45 20	YL-BR BR-YL YL-SL SL-YL	GN RD BK YL	TA RA TB RB	T R PT PR	T R	T R E M		3A 3B 4A 4B	PORT 10 "42" (74)	PORT 22 "54" (86)	N/C
46 21 47 22	VI-BL BL-VI VI-OR OR-VI	GN RD BK YL	TA RA TB RB	T R PT PR	T R	N/C	T R T1 R1	5A 5B 6A 6B	PORT 11 "43" (75)	PORT 23 "55" (87)	N/C
48 23 49 24	VI-GN GN-VI VI-BR BR-VI	GN RD BK YL	TA RA TB RB	T R PT PR	T R	N/C	T R T1 R1	N/C	PORT 12 "44" (76)	PORT 24 "56" (88)	N/C
50 25	VI-SL SL-VI	-- --	N/C N/C	N/C N/C	N/C N/C	N/C N/C	N/C N/C	N/C N/C	N/C N/C	N/C N/C	N/C N/C

NOTE 1: Number shown in "quotes" is the port number associated with the first ESE-32E-1 CCU. Number shown in (parentheses) is the port number associated with the second ESE-32E-1 CCU.

NOTE 2: VMI-E does not provide power failure transfer.



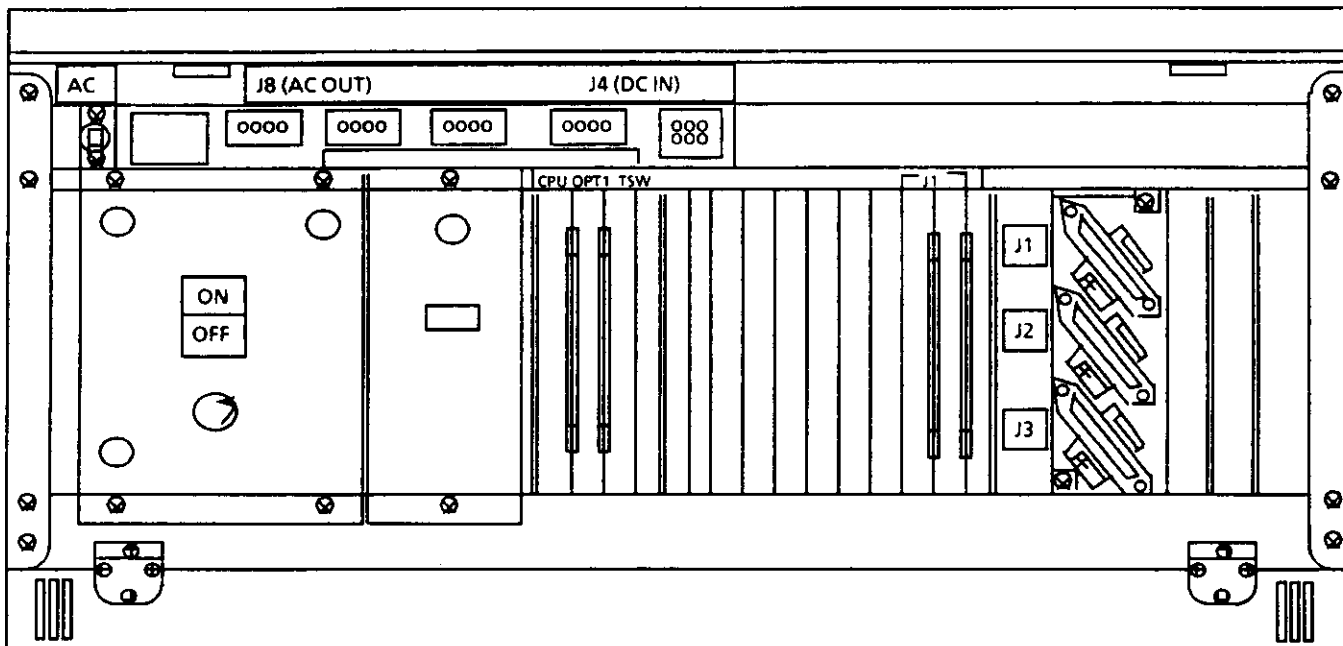

Figure 230-2 Front View of ESE-32B-1 CCU

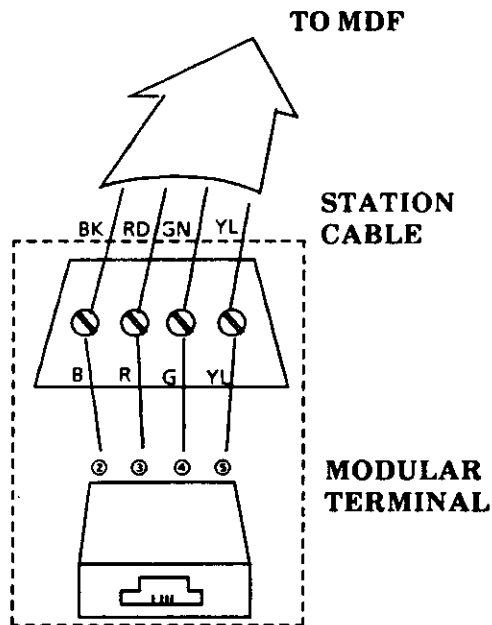

Figure 230-3 View of Modular Terminal for Connection of Multiline Terminals, DSS/BLF, CO Add-On Modules, RAA-E, and SLT

B. Only DTMF dial, Single Line Telephones (SLT) (Standard 2500 Type) will be able to dial within the

Electra MarkII telephone system. One pair cabling is required; it is recommended that twisted pair cabling be used.

Refer to section 220, of this manual, for specifications, Table 230-1, for lead identifications and Figure 230-4, for simplified schematic of station termination.

C. When SLTs are installed in the system they can also operate as power failure telephones, by cross connection on the MDF.

As an example, to make a single line telephone ring on incoming calls to CO 3 during a power failure or brownout, connections on the MDF are as follows: (also refer to Table 230-1).

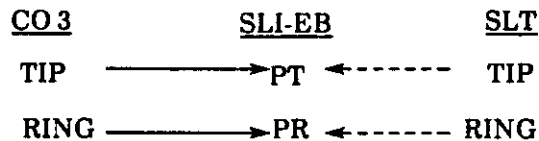

For additional CO line connections to additional SLTs, similar cross connections should be made.

**NOTE:** SLTs used for Power Failure Transfer must be supported by an SLI-EB ETU.

Since all of the SLTs are equipped with DTMF dials, the outside lines must allow tone dialing, if dialing during power failure is required.

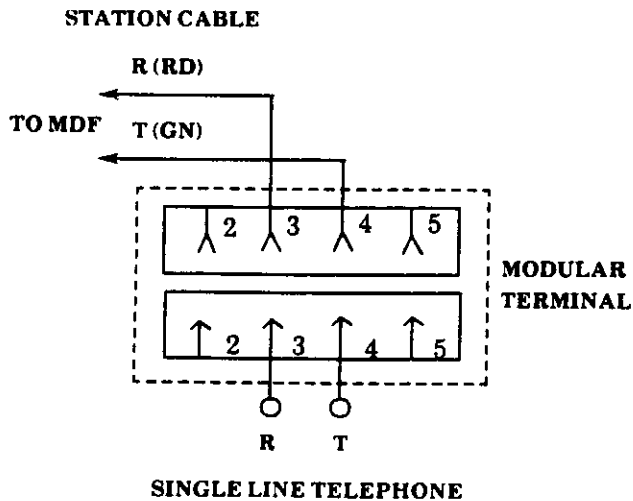

Figure 230-4 Simplified Schematic - Single Line Telephone Connection

## SECTION 240 CENTRAL CONTROL UNITS (CCUs) CONNECTION

### 240.1 WALL MOUNTING THE CCU

A. The ESE-32B-1 CCU is equipped with two wall mounting metal brackets. These brackets must first be detached from the CCU to properly wall mount it.

B. Unscrew the two screws located on the lower portion of the front panel, then remove the front panel by sliding it to the left. Place the panel and screws aside for later reinstallation.

C. Unscrew the two screws located on the top front of the CCU, then remove the top panel. Place the panel and screws aside for later reinstallation.

D. Unscrew the two screws located on the bottom front of the CCU, then remove the base panel. Place the panel and screws aside for future reinstallation.

E. Locate the two mounting screws on the upper rear of the CCU (holding the upper mounting bracket to the CCU), remove the two screws and the bracket.

F. Remove the two mounting screws holding the lower mounting bracket to the base panel.

G. Use the template provided with ESE-32B-1 CCU to layout CCU(s) in position. Install eight locally provided fasteners appropriately for wall mounting in positions shown on the template. CCU(s) must be mounted correctly for proper operation.

Install the wall mounting metal brackets as shown in Figure 240-1, using the eight locally provided fasteners.

Mount the base panel onto the lower bracket using the two screws removed in step F. (See Figure 240-1).

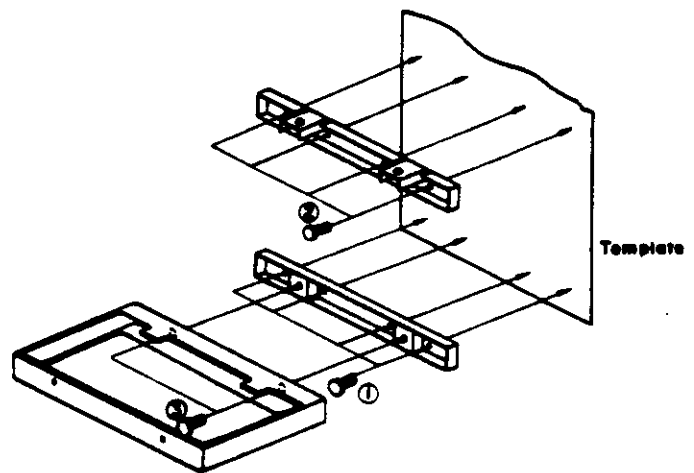

Figure 240-1 Wall Mounting Bracket and CCU Base Panel

Using the open slots provided on the back panel of the CCU, mount the CCU to the knobs of the upper bracket and onto the base panel. Make sure that the upper bracket knobs are fully seated within the open slots of the CCU. Tighten the screws from above the CCU to securely attach the CCU to the upper bracket knobs, also reinstall the two screws removed in step D as shown in Figure 240-2.

H. The ESE-32E-1 CCUs are equipped with one wall mounting bracket. This bracket must first be detached from the CCU to properly wall mount it.

I. When the first ESE-32E-1 CCU is to be installed, repeat step B. Locate the two mounting screws in the upper rear of the CCU (holding the mounting bracket to the CCU), remove the two screws and the bracket. Also, remove the two screws located on the top front of the CCU.

J. Mount the metal bracket using four locally provided fasteners as outlined with the template. Refer to Figure 240-1.

K. Insure that the hooks provided on the top rear of the ESE-32B-1 CCU are fully seated within the open slots on the bottom rear of the ESE-32E-1 CCU.

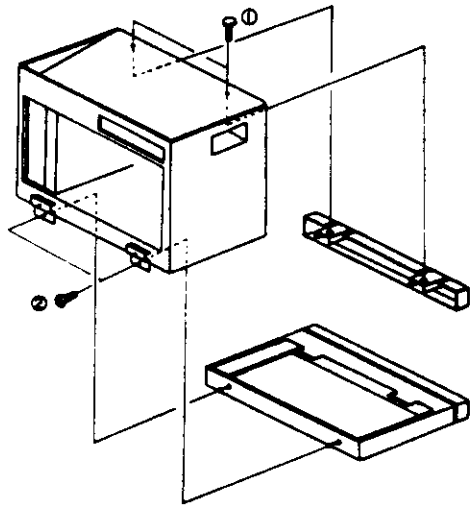

Figure 240-2 Wall Mounting ESE-32B-1 CCU

After mounting the ESE-32E-1 CCU onto the ESE-32B-1 CCU, secure them using the four screws removed in step I, as shown in Figure 240-3.

L. When the second ESE-32E-1 CCU is installed, it should be done in the same manner as the first ESE-32E-1 CCU.

M. Install the top panel onto the top CCU and secure with the screws removed in step C.

**NOTE:** All removed front panels should be reinstalled by securing with the screws removed in step B after the required ETUs are installed and the system is tested. (Refer to Figure 240-4).

#### 240.2 FLOOR MOUNTING THE CCU

The CCUs are designed to be wall mounted, when necessary, floor mounting can be accomplished by stacking the CCUs.

A. Place the ESE-32B-1 CCU in its permanent and safe location.

B. Unscrew the two screws located on the lower portion of the front panel, then remove the front panel by sliding it to the left. Place the panel and screws aside for later reinstallation.

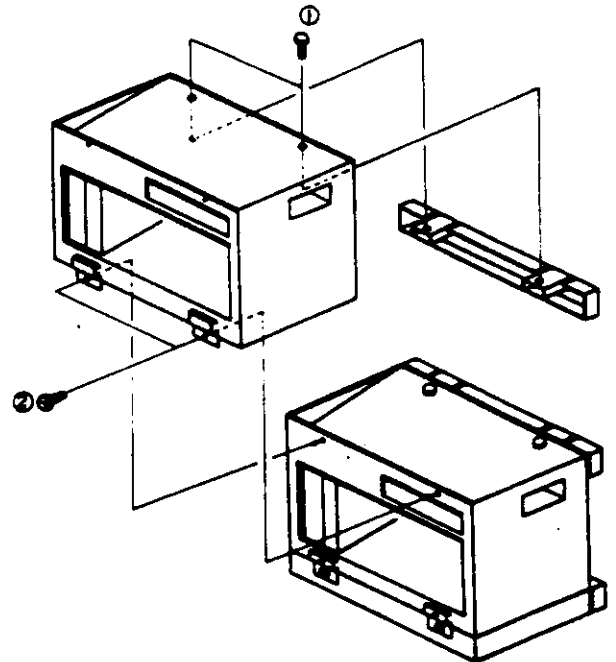

Figure 240-3 Wall Mounting ESE-32E-1 CCU

C. Unscrew the two screws located on the top front of the CCU, then remove the top panel. Place the panel and screws aside for later reinstallation.

D. When the first ESE-32E-1 CCU is to be installed, repeat step B. Remove the two screws located on the top front of the CCU, then, mount the CCU onto the ESE-32B-1 CCU.

E. Insure that the hooks provided on the top rear of the ESE-32B-1 CCU are fully seated within the open slots on the bottom rear of the ESE-32E-1 CCU. Secure them using the two screws removed in step D.

F. When the second ESE-32E-1 CCU is installed, it should be done in the same manner as the first ESE-32E-1 CCU.

G. Install the top panel onto the top CCU and secure with the screws removed in step C.

**240.3 GENERAL NOTES FOR ETU INSTALLATION**

A. It is recommended that power be OFF during installation and maintenance, unless this will seriously inconvenience the user. This will prevent accidental damage to equipment.

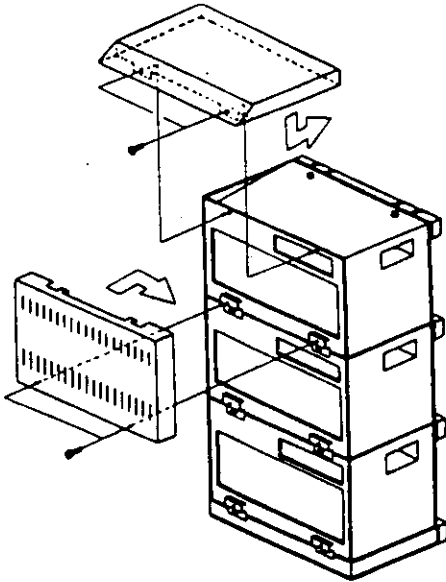

Figure 240-4 Installing Top Panel and Front Panel (s)

B. The ETUs used in this system make extensive use of CMOS technology. Extreme care must be taken to avoid static discharge when handling ETUs.

C. A switch is provided on the interface ETUs to protect circuitry from any damage during installation with system power ON.

D. The component side of ETUs must be on the right side when installed. (Viewed from the front as shown in Figure 240-5).

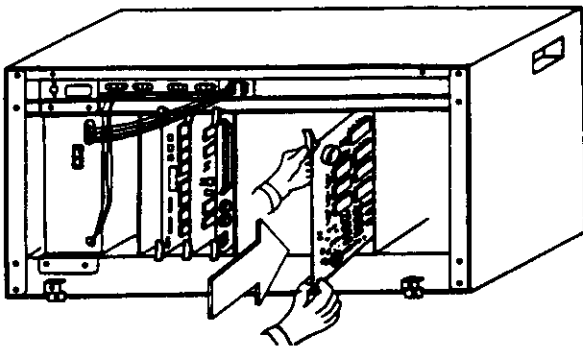

Figure 240-5 Installing ETUs

**240.4 COMMON CONTROL ETUs**

**A. CPU-E/CPU-EB ETU**

Prior to programming the system data, Switch 2 (SW2) must be set to the ON position to allow memory contents retention, in case of a power failure or brownout. Failure to activate the backup battery circuit will result in the system data returning to default values and the loss of speed dialing, callback request, message waiting, clock/calendar, station and trunk group name assignments, etc., if a power failure or brownout occurs.

Anytime a CPU-E or CPU-EB ETU is installed, the system clock/calendar must be set. This also applies when battery backup fails for any reason. This procedure is provided in Section 430 of this manual.

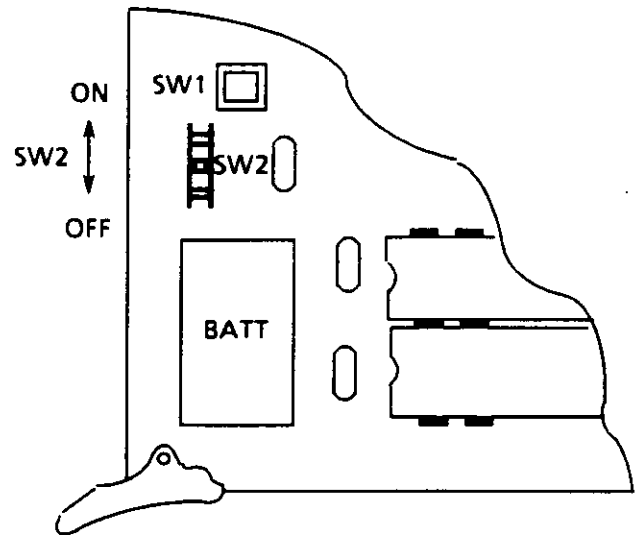

Figure 240-6 CPU-E( ) Switch Layout

When this ETU is removed for long-term storage, set the SW2 switch to OFF position. This will prevent the battery from constantly discharging. The battery, when fully charged, will retain memory contents for approximately 7 days.

Switch 1 (SW1) is the reset switch. When activated, this momentary switch causes all service in progress to be interrupted. This switch should not be used in an operating system unless absolutely necessary. The CPU-EB or CPU-E ETU must be installed in the CPU slot of the ESE-32B-1 CCU.

**B. TSW-E ETU**

The TSW-E ETU contains three switches, two LEDs, one connector, and two RCA phono plugs.

Switch 1 (SW1) is the reset switch. Depression of this momentary switch causes all service in progress (associated with the ESE-32B-1 CCU), to be interrupted. This switch should not be used in an operating system unless absolutely necessary.

The LEDs indicate module memory working status. Under normal operating conditions, they are fluttering to indicate memories being activated. When SW 1 is depressed, the LEDs momentarily turn OFF. Anytime the CCU is disabled, the LEDs are OFF.

Connector CN2 is used for data transmission between the TSW-E ETU and the MMC-E ETU in the first ESE-32E-1 CCU; the cable provided on the MMC-E ETU is plugged into this connector.

Switch IN/OUT (SW2) is used to choose the MOH source from either internal or external. When the music chip is used for MOH source, set this switch in the IN position. If external MOH source is connected, set this switch to the OUT position. (For external MOH source connection, instructions are provided in section 270 OPTIONAL EQUIPMENT CONNECTION.)

Switch labeled MELODY (SW3) is used to select one of two melodies, from the internal MOH source, generated by the music chip, mounted on the TSW-E ETU. VR1 is used to adjust the volume of the melody provided by the melody chip.

RCA phono plug EP is used for connection of a locally provided amplifier for external paging.

RCA phono plug MOH is used for the connection of an external MOH source, if needed.

The TSW-E ETU must be installed into the TSW slot in the ESE-32B-1 CCU

### C. MMC-E ETU

The MMC-E ETU contains one switch, two LEDs, one cable, and one connector. Switch 1 (SW1) is the reset switch. Depression of this switch causes all service associated with the CCU to be interrupted. This switch should not be used in an operating system unless absolutely necessary.

The LEDs indicate module memory working status. Under normal operating conditions, they flutter to

indicate memories being activated. When SW1 is depressed, the LEDs momentarily turn OFF. When the CCU is disabled, the LEDs are constantly OFF.

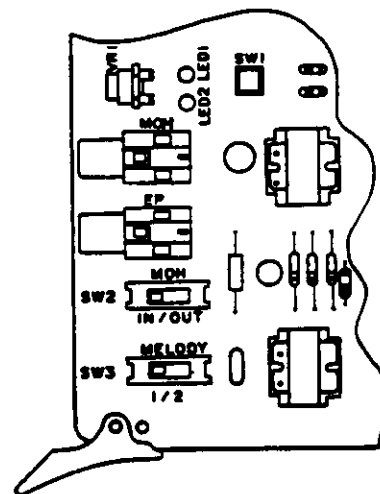

Figure 240-7 TSW-E Switch Layout

The flat cable must be connected to the connector on the TSW-E ETU or the other MMC-E ETU. When it is connected to the other MMC-E ETU, the cable of that MMC-E ETU must be already connected to the TSW-E ETU. Refer to Figure 240-8.

The MMC-E ETU must be installed in the MMC slot of an ESE-32E-1 CCU.

### 240.5 BASIC INTERFACE ETUs

Although the system scans all the slots to detect which devices are installed, it must be noted that this is only performed by the CPU-E( ) ETU during initial powering up of the system, or after a first initialization. At this time, all busy switches on all interface ETUs, must be set to the ON position.

Thereafter, if any device is installed and the system is not turned off or a first initialization is not performed, you should inform the system (by programming) of the location and type of device added.

- a) Prior to inserting (or removing) an ETU into an interface slot, as determined by the job specification, make sure the busy switch (SW1) on that ETU is in the OFF position.
- b) Insert the ETU into the interface slot.

c) Set the busy switch (SW1) on that ETU to the ON position.

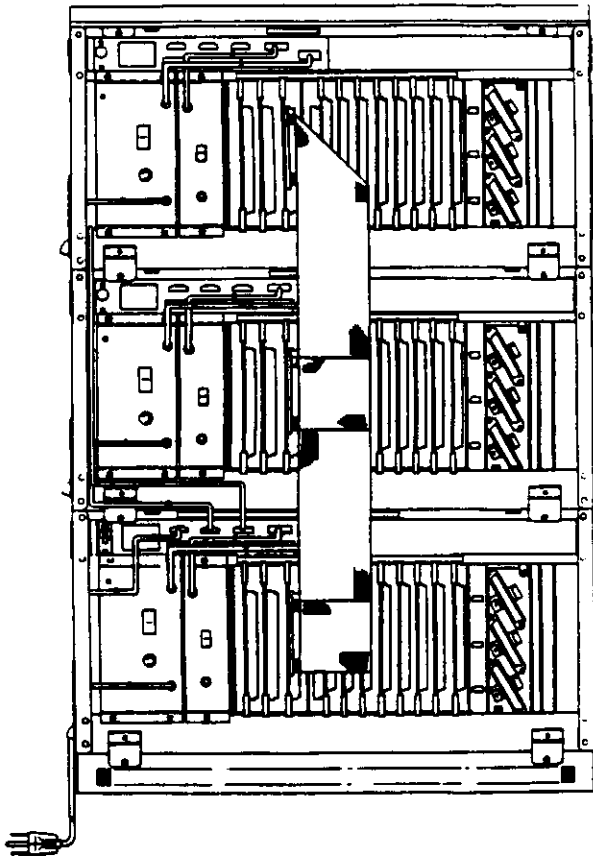

Figure 240-8 CCU Layout.

Each basic interface ETU has a busy switch (SW1), a power LED (Green) and four LEDs (red).

Setting the busy switch (SW1) to the ON position, after inserting the ETU, causes the power LED to light.

The four red LEDs indicate the status of circuits. Each LED ON indicates that its associated circuit is in use. Refer to Table 240-1, Interface ETU LED and Switch Reference.

**A. COI-E ETU**

The COI-E ETU contains four switches, which are designated SW101 to SW401, for the selection of trunk type. Each switch is associated with a circuit.

When a loop start trunk is connected to a circuit, its associated switch must be set to the LP position. If a

ground start trunk is connected, the switch must be set to the GD position.

LED 1 (Green) lit, indicates that the COI-E is receiving power.

LEDs 101 ~ 401 (Red) indicate the status of the four circuits. Each LED ON indicates its associated circuit is in use.

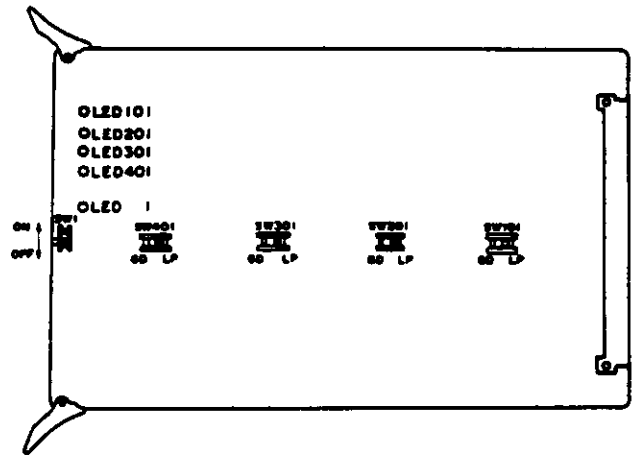

Figure 240-9 COI-E Switch Layout

A maximum of ten COI-E ETUs can be installed in a system, into any interface slots.

**B. TLI-E ETU**

The TLI-E ETU provides circuitry for servicing up to two lines; DID loop dial, 2 wire E&M Tie, or 4 wire E&M Tie lines. It contains ten switches and three LEDs.

Switches designated SW101 and SW201 are used to select the type of E&M Tie lines (2 or 4 wire).

**NOTE:** When loop dial lines are connected, these switches must be set to 2 wire position.

Switches designated SW102 and SW202 are used to select the type of lines (DID or E&M).

Switches designated SW103 and SW203 are used to select the type of E&M signaling (TYPE 1 or 5) for E&M Tie lines being used.

Switches designated SW301, SW302, SW401 and SW402 are four position dip switches used to select loss level for loop dial, DID, 2 and 4 wire E&M Tie lines. Loss levels can be adjusted for 0, 2, 4, 8, 12 or 16 db. (See Figure 240-10).

SW301 sets the transmission loss level for Channel 1.

SW 302 sets the reception loss level for Channel 1.

SW401 sets the transmission loss level for Channel 2.

SW402 sets the receiving loss level for Channel 2.

LEDs 1 and 2 (RED) indicate the status of the two circuits.

Each LED ON indicates its associated circuit is in use.

LED 3 (GREEN), when lit indicates the TLI-E ETU is receiving power.

A maximum of twenty TLI-E ETUs can be installed in a system, into any interface slots.

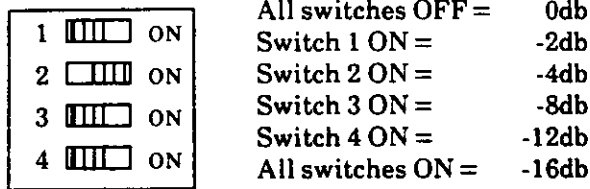

Figure 240-10 SW301, SW302, SW401 or SW402 pad switch settings on TLI-E ETU

### C. ESI-EA/EB ETU

Installing an ESI-EA or ESI-EB ETU provides support for up to four Multiline Terminal and/or EDE-30-1 units. The ESI-EB ETU is required when a Multiline Terminal is equipped with the DPA-E unit for the dual path feature, or a DTA-E unit for data capability.

LED LP1 (Green) lit, indicates that the ESI-E( ) is receiving power. LEDs 1 ~ 4 (Red) indicates the status of the four circuits. Each LED ON indicates its associated circuit is in use.

A maximum of twenty ESI-E( ) ETUs can be installed in a system, into an interface slot.

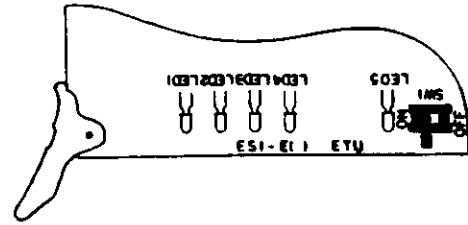

Figure 240-11 ESI-E( ) Busy Switch with LEDs

### D. SLI-EA/EB ETU

Installing an SLI-EA or SLI-EB ETU provides support for up to four single line telephones and modems or Dterm IIs. The SLI-EB ETU is required when power failure transfer of CO lines and/or message wait signaling to single line telephones and/or voice mail messaging is used in the system.

LED 1 (Green) lit, indicates that the SLI-E( ) is receiving power. LEDs 101 ~ 401 (Red) indicates the status of the four circuits. Each LED ON indicates its associated circuit is in use.

A maximum of eighteen SLI-E( ) ETUs can be installed in a system into any interface slot. SLI-E( ) ETUs require the support of at least one RSG-E unit and an MFR-EA ETU. (Refer to tables 220-2 and 220-3)

### E. MFR-EA ETU

The MFR-EA ETU contains a switch and an LED. When inserting or removing an MFR-EA with power applied to the CCU, switch 1 (SW1) must be set to the OFF position.

LED 1 (green) lit indicates that the MFR-EA is receiving power.

A maximum of four MFR-EA ETUs can be installed in a system into any interface slot to provide a maximum of 8 circuits. The MFR-EA ETU is required to support the dialing of any SLTs, modems and/or VMI-E ETU installed.

## 240.6 OPTIONAL INTERFACE ETUs

### A. CNF-E ETU

The CNF-E ETU contains a switch (SW1) and an LED.

SW1 is used to remove power from the ETU when the ETU is removed or inserted without powering down the CCU.

Table 240-1 Interface ETU LED/Switch Reference

ETU	PORT	LED	SWITCH
COI-E	1	LED 101 - Busy 1	SW 101 - Trunk Selection (Loop/Ground)
	2	LED 201 - Busy 2	SW 201 - Trunk Selection (Loop/Ground)
	3	LED 301 - Busy 3	SW 301 - Trunk Selection (Loop/Ground)
	4	LED 401 - Busy 4	SW 401 - Trunk Selection (Loop/Ground)
		LED 1 - Receiving Power	SW 1 - Busy Out
ESI-E ( )	1	LED 1 - Busy 1	
	2	LED 2 - Busy 2	
	3	LED 3 - Busy 3	
	4	LED 4 - Busy 4	
		LED 5 - Receiving Power	SW 1 - Busy Out
SLI-E ( ) & VMI-E	1	LED 101 - Busy 1	
	2	LED 201 - Busy 2	
	3	LED 301 - Busy 3	
	4	LED 401 - Busy 4	
		LED 1 - Receiving Power	SW 1 - Busy Out
MFR-EA & CNF-E & ECR-E		LED 1 - Receiving Power	SW 1 - Busy Out
TLI-E	1	LED 1 - Busy 1	SW 101 - E & M Type Selection (2 or 4 wire) SW 102 - Trunk Selection (Loop DID or E & M Tie lines) SW 103 - E & M Signaling Type Selection (1 or 5) SW 301 - Transmission Loss Level Selection SW 302 - Receiving Loss Level Selection
	2	LED 2 - Busy 2	SW 201 - E & M Type Selection (2 or 4 wire) SW 202 - Trunk Selection (Loop DID or E & M Tie lines) SW 203 - E & M Signaling Type Selection (1 or 5) SW 401 - Transmission Loss Level Selection SW 402 - Receiving Loss Level Selection
		LED 3 - Receiving Power	SW 1 - Busy Out

NOTE: When a loop dial trunk(s) is connected to the TLI-E ETU, SW 101 and/or SW201 on the ETU must be set to the 2 wire position.



LED 1 (green) lit, indicates that the CNF-E ETU is receiving power.

A maximum of four CNF-E ETUs can be installed in a system, into any interface slots.

### B. ECR-E ETU

The ECR-E ETU contains two switches (SW1 and SW2), an LED, a volume control (VOL 1), three RCA phono plugs (J1, J2, J3), and two screw terminal blocks (CN1 and CN2).

SW1 is used to remove power from the ETU when the ETU is removed or inserted without powering down the CCU.

LED 1 (green) lit, indicates that the ECR-E ETU is receiving power. Phono plugs J2 and J3 are inputs of the BGM sources.

VOL 1 is used to adjust the audible level of the external tone ringer output. J1 provides an uninterrupted ring tone.

For installing options, see section 270 OPTIONAL EQUIPMENT CONNECTION.

One ECR-E ETU can be installed in a system, into any interface slot.

### C. VMI-E ETU

The VMI-E ETU contains a switch (SW1) and five LEDs (LED 1, LED 101 ~ 401).

SW1 is used to remove power from the ETU when the ETU is removed or inserted without powering down the CCU.

LED 1 (green) lit, indicates that the VMI-E ETU is receiving power.

LEDs 101 ~ 401 (red) lit, indicate the status of circuits. Each LED ON indicates its associated circuit in use.

One VMI-E ETU can be installed in a system, into any interface slot. The VMI-E ETU requires the support of an MFR-EA ETU and an RSG-E unit.

### 240.7 SMDR-E ETU

The SMDR-E ETU contains three switches, an LED and an RS-232C connector ended cable.

1. Switch 2, designated SW2 RESET, is a slide switch used to reset the SMDR-E ETU, with interruption of all ongoing operation. This switch is also used to remove power from the ETU when it is removed or inserted without powering down the CCU.

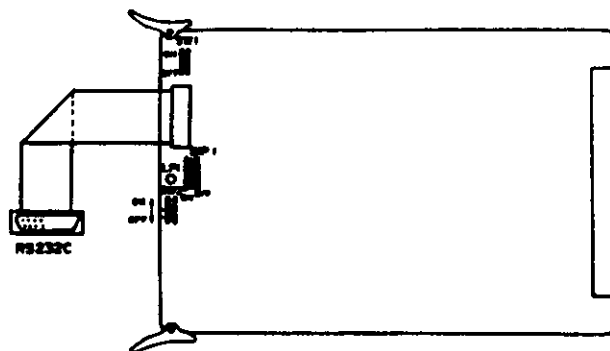

Figure 240-12 SMDR-E ETU Switch Layout

Switch 1, designated SW1 ON-OFF, is used to connect backup battery to the SMDR-E ETUs memory. This switch should be set to the ON position to allow memory retention during power failure or brownouts.

Switch DIP1 is a 5 position DIP switch which is used to select a baud rate (300 ~ 4800).

LED 1 (green) lit, indicates that the SMDR-E ETU is receiving power.

### 2. Connection of SMDR

a. The SMDR-E ETU must be installed into either OPT1 or OPT2 slot (or a combination slot) of any CCU. Prior to installing the SMDR-E ETU, ensure that switch SW1 is set to the ON position and that the baud rate switch, DIP1, is set to the proper position.

When installing the SMDR-E ETU, turn SW2 OFF for insertion of this ETU to the slot without powering down the CCU.

b. Route the RS-232C connector ended cable down and to the right side of the CCU in a manner to avoid interference with the insertion and the removal of ETUs and with the 25-pair cables from J1 ~ J3 connectors. Remove the access panel on the

right side of the CCU, which covers seven openings, to mount RS-232C connectors. (See Figure 240-14). Mount the RS-232C connector in one of the openings using screws and nuts locally provided. (See Figure 240-15).

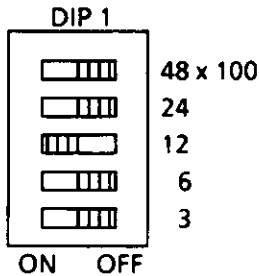

Figure 240-13 SMDR-E DIP 1 Switch

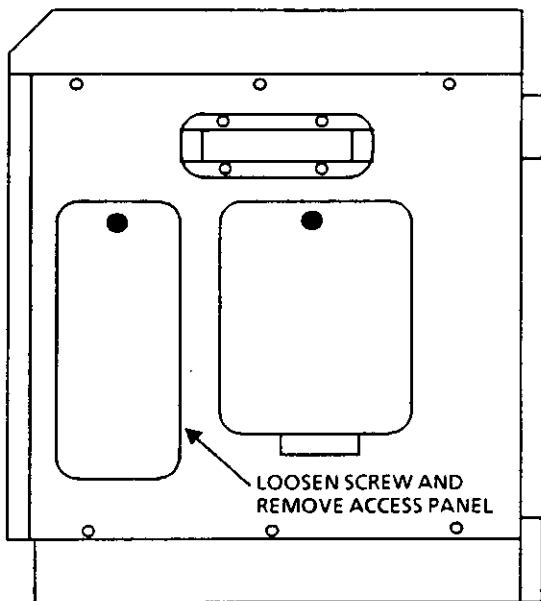

Figure 240-14 Right Side View of CCU

c. Connect a printer or other peripheral device to the RS-232C connector mounted on the CCU in step b and secure the RS-232C male connector from the printer or other peripheral device, with screws provided with the device.

d. Turn ON the SW2 of the SMDR-E ETU.

3. A 25 pin RS-232C connector is provided with the following pin configuration. (All pins are active high).

SMDR-E Output Connector

<u>PIN #</u>	<u>FUNCTION</u>
2	TXD (Transmit Data)
3	RXD (Receive Data)
4	RTS (Request To Send)
5	CTS (Clear To Send)
6	DSR (Data Set Ready)
7	Signal Ground
8	DCD (Data Carrier Detect) (constant high)
20	DTR (Data Terminal Ready)

SMDR print-out string is as follows:

- ASCII
- 7 bits, plus one parity bit (even)
- one stop-bit.

4. SMDR Output Format

For SMDR general format and sample printouts of call record, See Figures 240-16 and 240-17.

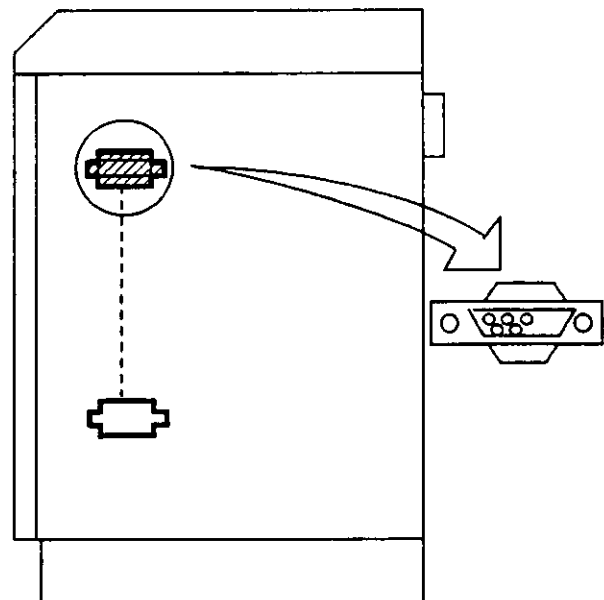
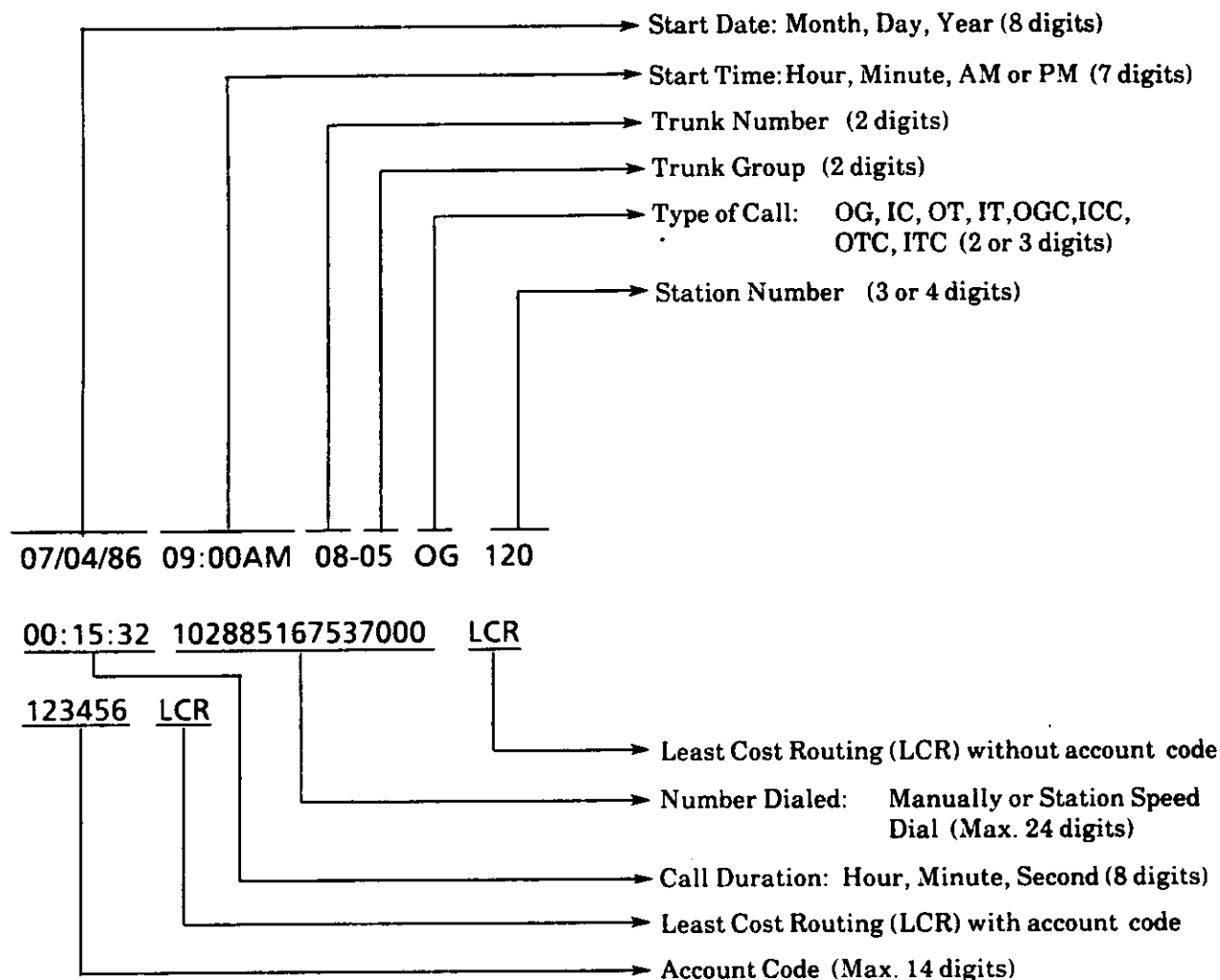

Figure 240-15 Mounting the RS-232C Connector



NOTE 1: A maximum of 34 digits can be printed per line.

NOTE 2: Types of calls are as follows:

- OG: Outgoing Call
- IC: Incoming Call
- OT: Transferred Outgoing Call
- IT: Transferred Incoming Call
- OGC: Conference on Outgoing Call
- ICC: Conference on Incoming Call
- OTC: Conference on Transferred Outgoing Call
- ITC: Conference on Transferred Incoming Call

Figure 240-16 SMDR General Format of Call Records

**INCOMING CALLS**

Incoming Call Without an Account Code:

07/04/86 09:00AM 08-05 IC 120  
 00:15:32

Incoming Call With an Account Code:

07/04/86 09:00AM 08-05 IC 120  
 00:15:32  
3456217  
 └───────────>Account Code (Max. 14 digits)

**TRANSFERRED CALLS**

Transferred Call Without an Account Code:

07/04/86 09:00AM 08-05 IT 120 123  
 00:05:45

Transferred Call With an Account Code:

07/04/86 09:00AM 08-05 IT 120 123  
 00:05:45  
 345621798

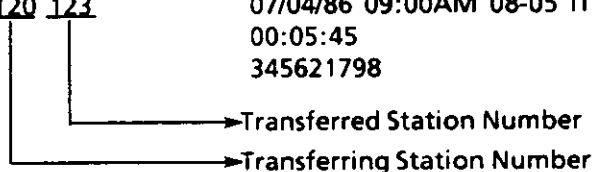

**CONFERENCE CALLS**

A conference call is printed in the following sequence:

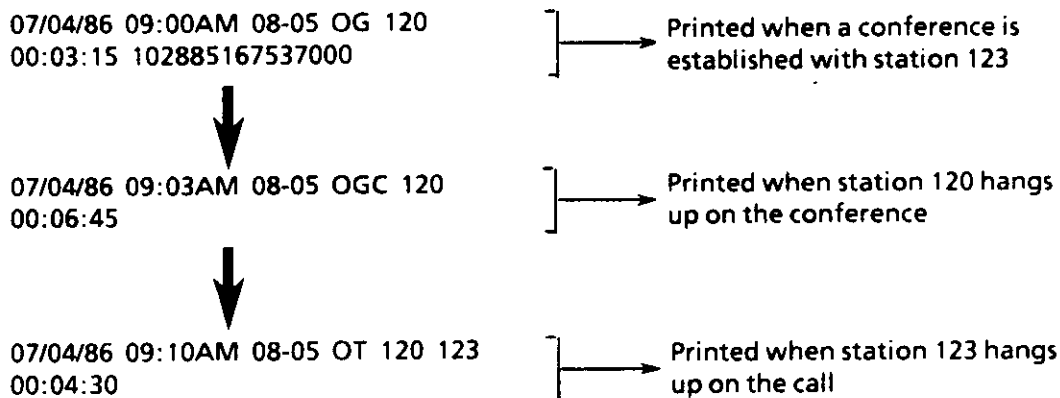

**OUTGOING CALLS USING SYSTEM SPEED DIAL**

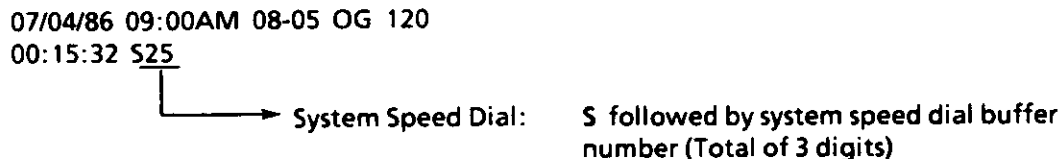

Figure 240-17 SMDR Sample Printouts of Call Records

### 240.8 LCR-E ETU

The LCR-E ETU contains three switches, an LED and a RS-232C connector ended cable.

1. Switch 2, designated SW2 RESET, is a slide switch used to reset the LCR-E ETU, with interruption of all ongoing operation. This switch is also used to remove power from the ETU when the ETU is removed or inserted without powering down the CCU.

Switch 1, designated SW1, is used to connect backup battery to the LCR-E MEMORY. This switch should be set to the ON position to allow memory retention during power failure or brownouts.

Switch DIP1 is a 7 position dip switch which is used to select baud rates in the range of 150 ~ 9600.

LED 1 (green) lit, indicates that the LCR-E ETU is receiving power.

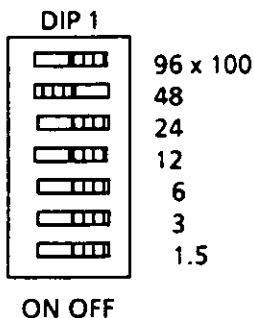

Figure 240-18 LCR-E DIP 1 Switch

### 2. Connection of LCR

a. The LCR-E ETU must be installed into either OPT1 or OPT2 or any combination slot of any CCU. Prior to installation, ensure that switch SW1 is set to the ON position and that the baud rate switch DIP1 is set to the proper position.

When installing the LCR-E ETU, turn SW2 OFF for insertion of this ETU to the slot without powering down the CCU.

b. A 25 pin RS-232C connector is provided to connect the portable computer in order to input necessary data into the LCR-E ETU.

c. Route the RS-232C connector ended cable down to the right side of the CCU in such a way as to avoid interference with the insertion and removal of ETUs and with the 25 pair cables from the J1 ~ J3 connectors.

Remove the access panel on the right side of the CCU, which covers seven openings, provided to mount RS-232C connectors. (See Figure 240-14).

Mount the RS-232C connector in one of these openings using screws and nuts locally provided. (See Figure 240-15).

d. Connect the portable computer to the RS-232C connector mounted on the CCU in step c and secure the RS-232C male connector from the computer using screws locally provided.

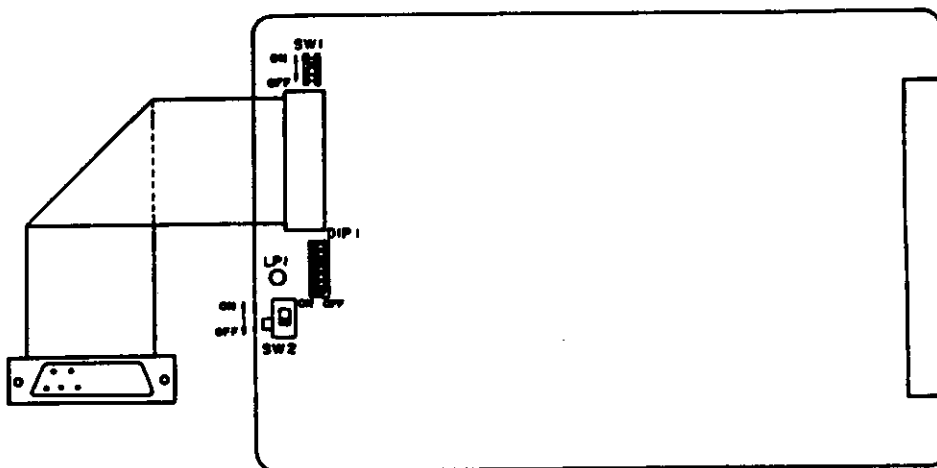

Figure 240-19 LCR-E ETU Switch Layout

- e. Turn ON the SW2 on the LCR-E ETU.
- 4. LCR data input is done from the portable computer.

For LCR programming, refer to Chapter 7 of this manual.

## SECTION 250 POWER SUPPLY INSTALLATION

### 250.1 PSE-AD-1 PSU

**NOTE:** Before proceeding, ensure that the Power Line Cord is not plugged into the AC receptacle and the system AC power switch located in the left front side of the ESE-32B-1 CCU just above the card slots is in the OFF (down) position. The three prong AC Power Line Cord is factory provided and is connected to the terminal block located at the left side of the ESE-32B-1 CCU.

- A. Remove the four mounting screws located at the top and bottom of the PSU slot in each CCU. Place the screws aside for later PSU installation.
- B. Install a PSE-AD-1 PSU into the PSU slot in each CCU, as shown in Figure 250-1, making sure that its power switch is in the OFF position.
- C. Secure each PSU with four screws previously removed in step A.

D. Two cables are provided on each PSE-AD-1 PSU. One is a 3 pin connector ended AC OUT power cable, the other is a 6 pin connector ended DC IN power cable.

Connect the AC OUT power cable to any of the AC connectors (J6 ~ J8) located immediately above its corresponding ESE-32B-1 CCU card slots. (See Figure 250-2).

Connect each DC IN power cable of each PSU to the 6 pin (J4) connector located immediately above its corresponding CCU. (See Figure 250-2).

E. Plug in the 3 prong AC Power Line Cord into the 117V AC receptacle and check the DC output voltages, which can be read on the corresponding 6 pin connector (J4) of each CCU, in accordance with Figure 250-3.

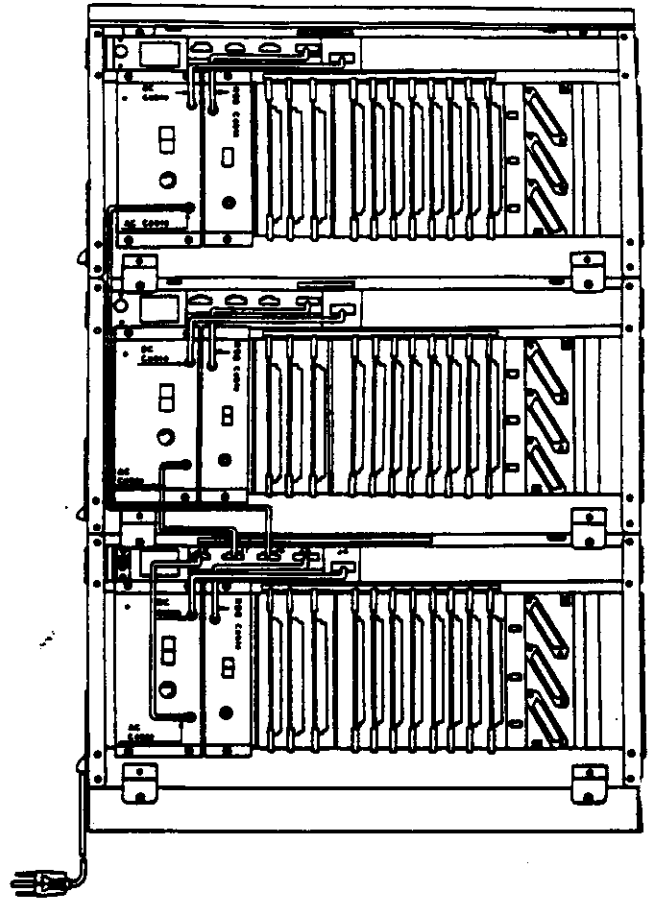

Figure 250-1 Connection of PSU Cable

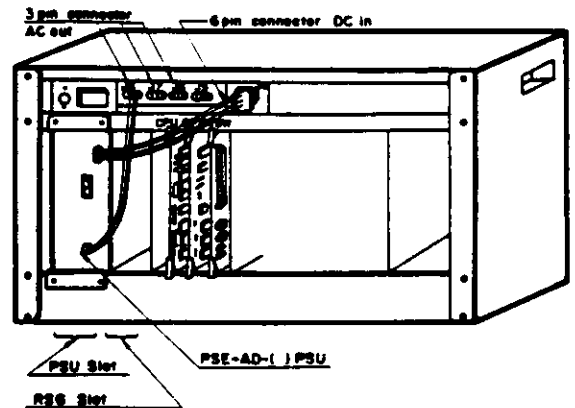

Figure 250-2 Installing PSE-AD-1 PSU

The voltages for each PSU can be checked individually by first turning on the system AC switch and then the switches on each power supply.

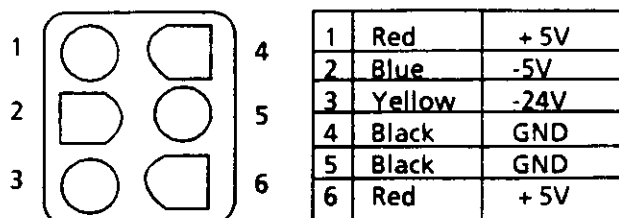

Figure 250-3 Front View of 6 Pin Connector of PSE-AD-1 and PSE-DD-1 PSUs

### 250.2 PSE-DD-1 PSU

**NOTE:** Before proceeding to install the PSE-DD-1 PSUs, ensure the Input Line Cords are not connected to the locally provided -48VDC power source and the input power switches on each PSE-DD-1 PSU are in the **OFF** position. The Input Line Cords for the PSE-DD-1 PSUs must be locally provided.

A. Remove the four mounting screws located at the top and bottom of the PSU slot, in each CCU. Place the screws aside for later reuse.

B. Install a PSE-DD-1 PSU into the PSU slot in each CCU, making sure its power switch is in the **OFF** position.

C. Secure each PSU with the four screws removed in step A.

D. One cable is provided with each PSE-DD-1 PSU. This cable is a 6 pin connector ended, DC IN power cable. Connect each DC IN power cable of each PSU to the 6 pin (J4) connector located immediately above in its CCU. (See Figure 250-4)

E. One screw terminal block provided with four screws is located on the lower front of each PSE-DD-1 PSU. Connect three PSE-DD-1 PSUs using locally provided cables, as shown in Figure 250-5.

F. Connect the first PSE-DD-1, installed in the ESE-32B-1 CCU, to the output of the locally provided -48 VDC power source, using a locally provided cable.

G. 1. Turn on the locally provided -48 VDC power source.

2. Turn on the power switch on the PSE-DD-1 PSU located in the second ESE-32E-1 CCU.

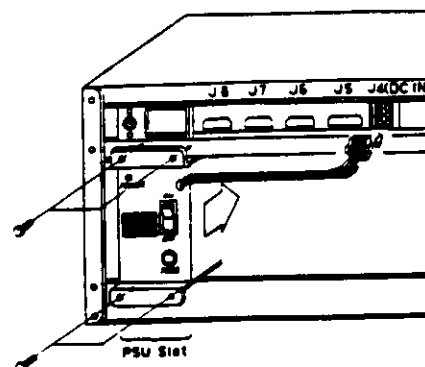

Figure 250-4 Installing PSE-DD-1 PSU.

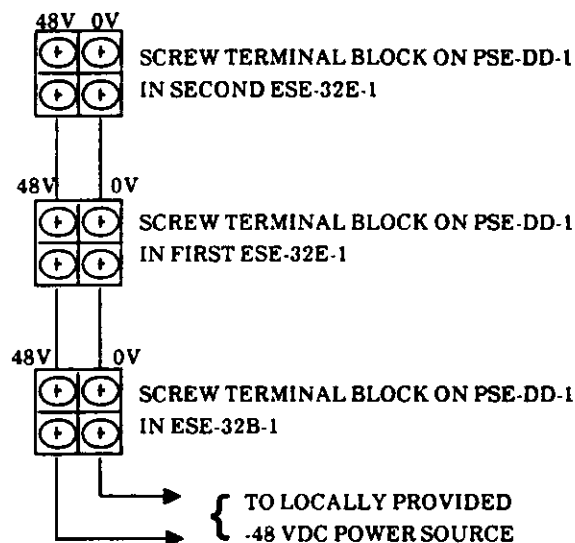

Figure 250-5 Interconnection of PSE-DD-1 PSU.

3. Turn on the power switch on the PSE-DD-1 PSU located in the first ESE-32E-1 CCU.

4. Turn on the power switch on the PSE-DD-1 PSU located in the ESE-32B-1 CCU.

H. Check the DC output voltages. These voltages can be checked at the test pins on the CPU-E or CPU-EB ETU, or on the MMC-E ETU in the corresponding CCU.

**250.3 RSG-E UNIT**

**NOTE:** System power should be off during these procedures.

- A. Remove the two mounting screws located at the top and bottom of the RSG slot in a CCU where SLI-EA, SLI-EB or VMI-E ETUs are installed.
- B. Install an RSG-E unit into the RSG slot of the required CCU, as shown in Figure 250-6.
- C. Secure the RSG-E unit with the screws previously removed in step A.

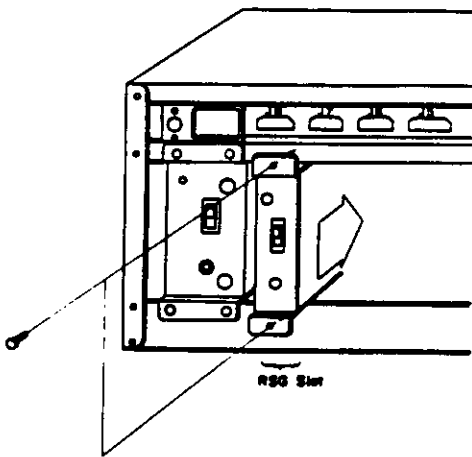

Figure 250-6 Installing RSG-E Unit

D. Connect the 4 pin connector ended cable, provided on the RSG-E unit, into the designated RSG connector (J5) located in the upper left of the CCU.

If the adjacent CCU requires ringing signal, use the supplementary cable, included in the RSG packing box.

Connect an end of the cable into the connector on the RSG-E unit and the other end of the cable into the designated RSG connector (J5) located in the upper left of the adjacent CCU.

E. Turn the PSU and the RSG-E ON, then check the AC output voltage, which can be read on the 4 pin connector of the CCU, as shown in Figure 250-7.

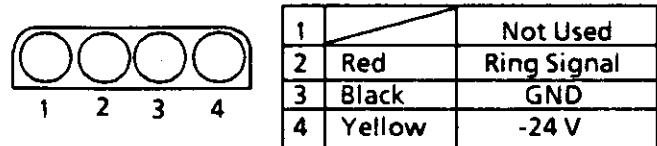

Figure 250-7 Front View of 4 Pin Connector of RSG-E Unit

**SECTION 260  
 ANCILLARY DEVICE CONNECTION**

**260.1 GENERAL INFORMATION**

A. Multiline Terminals can be equipped with ancillary devices such as HFU-E, DPA-E, DTA-E and ADA-E.

B. These optional units and their compatibility with Multiline Terminals are shown in Table 260-1.

C. These optional devices are installed inside the access panel on the bottom of Multiline Terminals. A maximum of one unit of each can be installed in each Multiline Terminals, except for ETE-6-1, which can only accept the ADA-E unit. The DTA-E comes with a special access panel to allow its installation into the Multiline Terminals.

D. Prior to installing any optional device, unplug the line cord from the Multiline Terminal and the RJ11C/W.

Table 260-1 Ancillary Device / Multiline Terminal Compatibility

ANCILLARY DEVICES	MULTILINE TERMINALS			
	ETE-6-1	ETE-6D-1	ETE-16D-1	ETE-16K-1
HFU-E		●	●	●
DPA-E		●	●	●
ADA-E	●	●	●	●
DTA-E		●	●	●

● = Compatible



## 260.2. HANDSFREE UNIT (HFU-E)

**NOTE:** Installation in all Multiline Terminals except the ETE-6-1.

A. Unplug the line cord at the RJ11C/W, then turn the Multiline Terminal upside down (face down) and locate the access panel on the bottom of the Multiline Terminal. Refer to Figure 260-1.

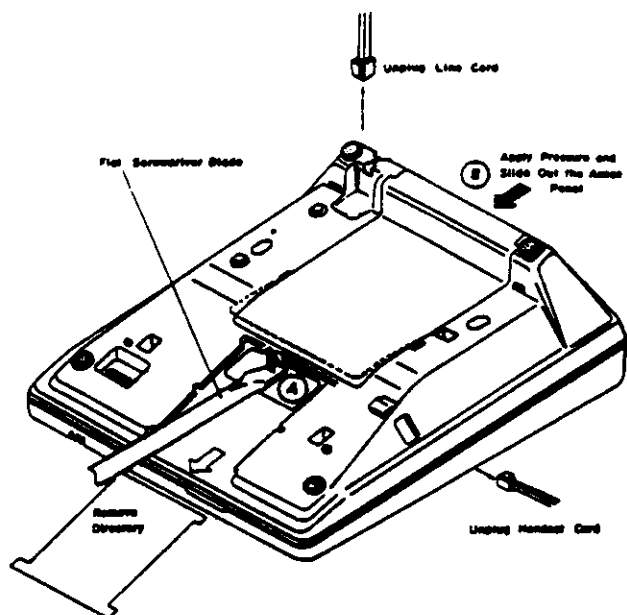

Figure 260-1 Multiline Terminal Access Panel Removal

B. Slide the directory out of the way.

C. Insert flat screwdriver blade into notched opening (shown as A) and apply light upward pressure until access panel is cleared of the front lip, at the same time apply pressure (towards you) at the rear of the pedestal (shown as B) until the access panel moves towards you.

D. Remove the access panel and place it aside for later reinstallation.

E. Locate the fourteen pin jack labeled HFU-E, as seen through the access view of the housing, insert the fourteen pin connector from the HFU-E unit, as shown in Figure 260-2.

F. Place the HFU-E unit into its designated area, with the cable side down.

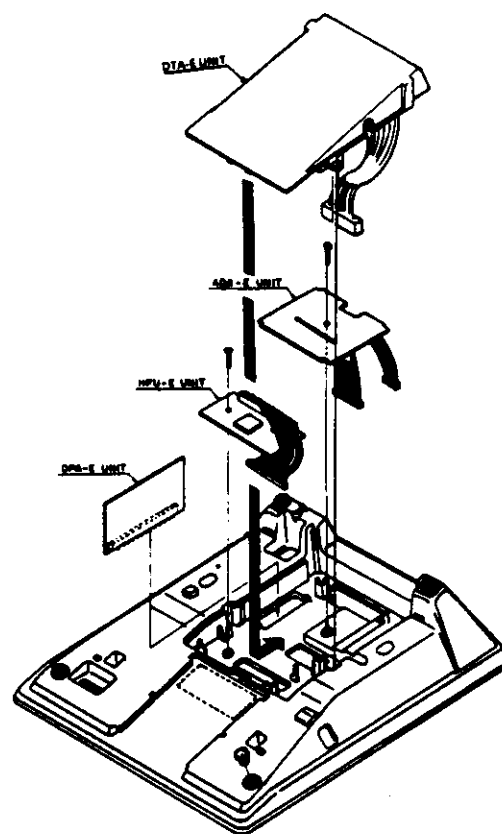

Figure 260-2 Optional Unit Installation

G. Secure the HFU-E unit by inserting the screw provided with the unit.

H. Replace the access panel

**OR**

continue to install the DPA-E unit, DTA-E unit, or ADA-E unit.

## 260.3 DUAL PATH ADAPTOR UNIT (DPA-E)

**NOTE:** Installation in all Multiline Terminals except the ETE-6-1.

A. Unplug the line cord at the RJ11C/W, then turn the Multiline Terminal upside down (face down) and locate the access panel on the bottom of the Multiline Terminal, refer to Figure 260-1

B. Slide the directory out of the way.

C. Insert flat screwdriver blade into notched opening (shown as A) and apply light upward pressure until access panel is cleared of the front lip, at the same time apply pressure (towards you) at the rear of the pedestal (shown as B) until the access panel moves toward you.

D. Remove the access panel and place it aside for later reinstallation.

E. Locate the thirteen pin connector labeled DPA-E, as seen through the access view of the key telephone housing, seat the DPA-E unit into this connector, using care, securely insert the unit into the notched cavity, refer to Figure 260-2.

F. Replace the access panel

**OR**

continue to install the ADA-E unit, DTA-E unit, or HFU-E unit.

#### **260.4 ANCILLARY DEVICE ADAPTOR UNIT (ADA-E)**

**NOTE:** Installation in all Multiline Terminals except the ETE-6-1.

A. Unplug the line cord at the RJ11C/W, then turn the Multiline Terminal upside down (face down) and locate the access panel on the bottom of the Multiline Terminal, refer to Figure 260-1.

B. Slide the directory out of the way.

C. Insert flat screwdriver blade into notched opening (shown as A) and apply light upward pressure until access panel is cleared of the front lip, at the same time apply pressure (towards you) at the rear of the pedestal (shown as B) until the access panel moves towards you.

D. Remove the access panel and place it aside for later reinstallation.

E. Locate the eight pin jack labeled ADA, as seen through the access view of the Multiline Terminal housing, just below is a four pin connector and jack labeled HAND, refer to Figure 260-2.

F. Unplug the four pin connector ended harness (labeled HAND) and extend it out from the housing access hole.

G. Locate the four pin connector ended harness from CN1 on the ADA-E unit into the jack labeled HAND.

H. Locate and insert the eight pin connector ended harness from CN1 and CN2 on the ADA-E unit into the jack labeled ADA.

I. Insert the four pin connector ended harness, removed in step F, from the Multiline Terminal into the four pin jack, CN3, located on the ADA-E unit.

J. The ADA-E unit is mounted component side down after termination of the optional device required (Refer to Engineering Technical Information (ETI) Bulletins for various device hookups).

K. Secure the ADA-E unit by inserting the screw provided with the unit.

L. Replace the access panel

**OR**

Set up to install the HFU-E unit, DTA-E unit, or the DPA-E-unit.

#### **260.5 ADA-E INSTALLATION INTO A ETE-6-1 MULTILINE TERMINAL**

A. Unplug the line cord at the RJ11C/W, then turn the Multiline Terminal upside down (face down) and locate the access panel on the bottom of the Multiline Terminal, refer to Figure 260-1.

B. Slide the directory out of the way.

C. Depress the flexible key tab on the access panel and apply upward pressure.

D. Remove the access panel and place it aside for later reinstallation.

E. Locate the eight pin jack labeled ADA, as seen through the access view of the Multiline Terminal housing, just below is a four pin connector and jack labeled HAND, refer to Figure 260-3.

F. Unplug the four pin connector ended harness (labeled HAND) and extend it out from the housing access hole.

G. Locate CN2, and insert the four pin connector ended harness from the ADA-E unit into the jack labeled **HAND**.

H. Locate CN1, and insert the eight pin connector ended harness from the ADA-E unit into the jack labeled **ADA**.

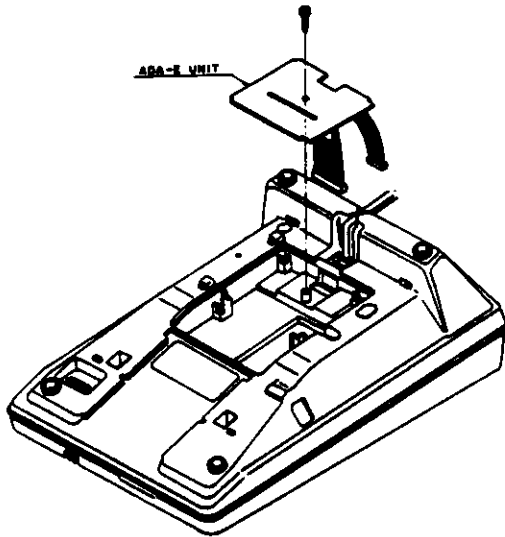

Figure 260-3 ADA-E Installation into an ETE-6-1 Multiline Terminal

I. Insert the four pin connector ended harness, removed in step F from the Multiline Terminal into the four pin jack , CN3, located on the ADA-E unit.

J. The ADA-E unit is mounted component side down after termination of the optional device required (Refer to Engineering Technical Information (ETI) Bulletins for various device hookups).

K. Secure the ADA-E unit by inserting the screw provided with the unit.

L. Replace the access panel.

### 260.6 DATA ADAPTOR UNIT (DTA-E)

**NOTE:** Installation in all Multiline Terminals except the ETE-6-1.

A. Unplug the line cord at the RJ11C/W, then turn the Multiline Terminal upside down (face down) and locate the access panel on the bottom of the Multiline Terminal (see Figure 260-1).

B. Slide the directory out of the way.

C. Insert flat screw driver blade into notched opening (shown as A) and apply light upward pressure until access panel is cleared of the front lip, at the same time apply pressure (towards you) at the rear of the pedestal (shown as B) until the access panel moves toward you.

Remove the access panel, discard or save for possible future use.

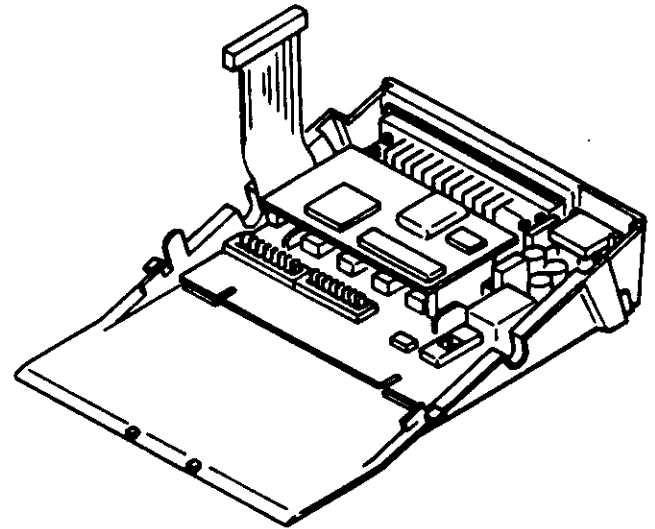

Figure 260-4 DTA-E Unit

D. Before installing the DTA-E unit, its switches should be set for the proper assignment. (Refer to Table 260-2).

The DTA-E unit contains a 7 position DIP switch designated SW1 a slide switch designated SW2, and an 8 position DIP switch designated SW3.

Table 260-2 DTA-E Switch Assignment

SWITCH NUMBER	SWITCH POSITION	SWITCH DESIGNATION	FUNCTION	SETTING	DESCRIPTION
SW 1 (DIP SWITCH)	1	ER	DTR (data terminal ready)	ON	DTR signal considered to be ON (positive) constantly.
				*OFF	DTR signal considered to be ON only when actually present from DTE.
	2	RS	RTS (request to send)	ON	RTS signal considered to be ON constantly.
				*OFF	RTS signal considered ON only when actually present from DTE.
	3	PB	PB (Peripheral busy)	*ON	PB considered to be ON constantly.
				OFF	PB considered to be ON only when actually present from DTE.
	4	SD	TD (Transmit data)	ON	TD considered to be on constantly.
				*OFF	TD considered to be on only when actually present from DTE.
	5	PB/ER	PB (Peripheral busy)	*ON	PB (ring indicator signal from modem) sent as DSR signal to modem when SW1-7 is set to the ON position.
			ER (Peripheral ready)	OFF	DTR signal from DTE sent as DSR signal to DTE when SW1-7 is set to the ON position.
	6	PR/PN	PR (Polarity reversed)	ON	PB signal (ring indicator from modem) considered ON when negative.
			PN (Polarity normal)	*OFF	PB signal considered ON when positive.
	7	DH/DS	DH (Data hardware controlled)	ON	DTR or PB signal (selected by SW1-5) sent to DTE or modem as DSR is hardware controlled.
			DS (Data software controlled)	*OFF	DSR signal is sent to DTE or modem via software control.

NOTE 1: DTR, RTS and PB signals and transmit data are considered ON when actually present from DTE regardless of switch setting on switch positions 1 ~ 4.

NOTE 2: All switches are set to the OFF position for shipping.

\* Denotes the recommended switch setting.

SW 2

POSITION	FUNCTION
ON	Loop back test mode
OFF	Normal Operation

Switch SW2 is used to perform a data loop-back test. A character entered via the DTE keyboard is echoed back from the DTA-E unit to the CRT display of the DTE. This test verifies that the transmission paths between the DTE and the DTA-E unit are established. While testing, the switch is set to ON. The switch must be set to OFF for normal operation.

SW 3

SWITCHN	RCS ON TIME	SWITCH POSITION
1	0 sec.	OFF
2	0.03 sec.	OFF
3	0.06 sec.	ON
4	0.12 sec.	OFF
5	0.24 sec.	OFF
6	0.72 sec.	OFF
7	1.1 sec.	OFF
8		ON (FD) OFF (HD)

NOTE: Switch 3, positions 1 ~ 7 is used to set the RS-232C RCS TIME (defining the time interval for sending the CTS signal after receiving the RTS signal) for the modem and position 8 is used to select either full duplex or half duplex.

● Only one switch of the first seven positions should be on the ON position at any time to assign the RCS ON TIME. Normally, switch 3 is set to ON.

● When switch in position 8 is ON (Full Duplex), switches in positions 1 ~ 7 do not affect operation.

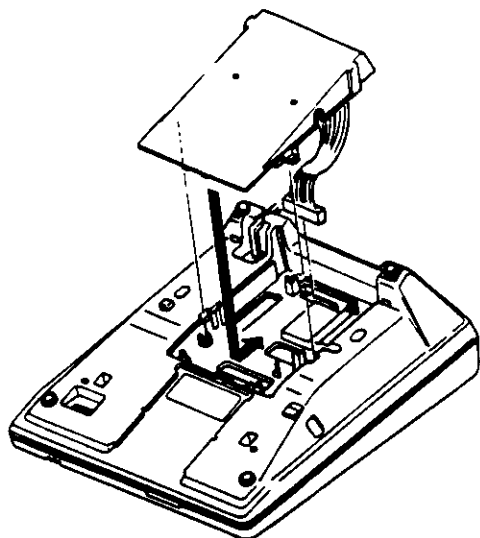

Figure 260-5 DTA-E Installation  
Table 260-1 shows the assignments of these switches.

E. After assigning the switches, locate the fifteen pin connector labeled DTE, as seen through the

access view of the Multiline Terminal housing, insert the fifteen pin connector from the DTA-E unit, as shown in Figure 260-4.

F. Replace the access panel.

OR

Continue to install the ADA-E unit, DPA-E unit, or HFU-E unit.

### 260.7 DTA-E INSTALLATION

#### A. DTA-E Installation

For DTA-E installation, refer to section 260.6 of this manual.

**NOTE:** Display Multiline Terminals with DTA-E units installed must be supported by an ESI-EB ETU and a CPU-EB ETU. If required, both DTA-E and DPA-E units can be installed in a display Multiline Terminal connected to channel 1 or 3 of an ESI-EB ETU. This arrangement is not possible when a Multiline Terminal is connected to channel 2 or 4 of

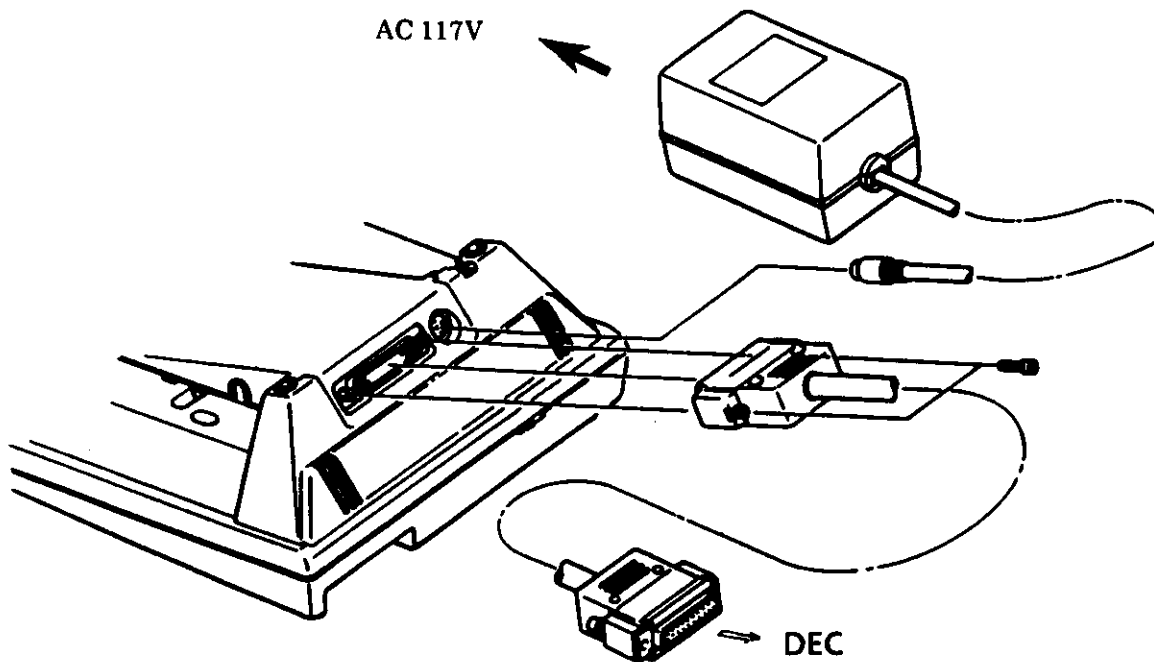

Fig. 260-6 Connection of DTE-DTA-E Unit

the same ESI-EB ETU that has either a DTA-E or a DPA-E ETU installed.

### B. Data Terminal Equipment Installation

Data terminal equipment (DTE) connected to the DTA-E units must be equipped with an RS-232C interface. Prior to connecting the DTE to the DTA-E unit, unplug the line cord of the Multiline Terminal and ensure that the power switch of the DTE is turned off.

B.1 Position a Multiline Terminal (with a DTA-E unit already installed) close to the data terminal to be connected.

B.2 Connect one end of a locally provided RS-232C straight cable to the RS-232C connector of the DTA-E unit. Refer to Figure 260.6.

B.3 Secure the RS-232C connector with screws provided with the RS-232C cable as shown in Figure 260.6.

B.4 Connect the other end of the RS-232C cable to the DTE as described in the instructions provided with the DTE.

B.5 Plug the line cord into the Multiline Terminal and connect the AC/DC adaptor to the connector provided on the DTA-E unit.

B.6 Apply power to the DTE.

### 260.8 WALL MOUNT UNIT INSTALLATION

1. Remove the Wall Mount Unit as shown.
2. Remove the backing from the Rubber Thumb Guards (A) to expose the pressure sensitive tape; install two (2) Rubber Thumb Guards as shown See Figure 260-7).
3. Install Plastic Mount Supports (B) into slots.

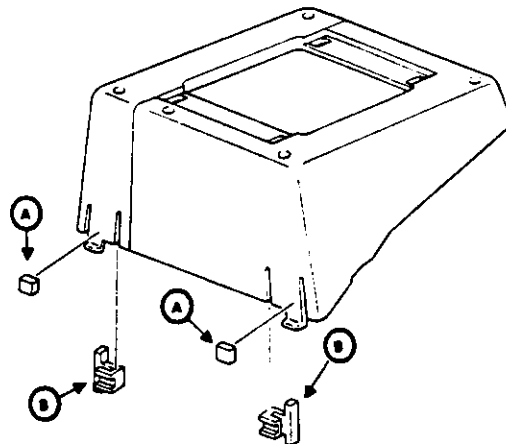

Figure 260-7

4. Attach the Wall Mount to the terminal by guiding the two straight tabs on the Wall Mount into the two notches on the top rear of the Multiline Terminal. Apply pressure to the Rubber Thumb Guards until the Wall Mount snaps in place attaching it securely (See Figure 260-8).

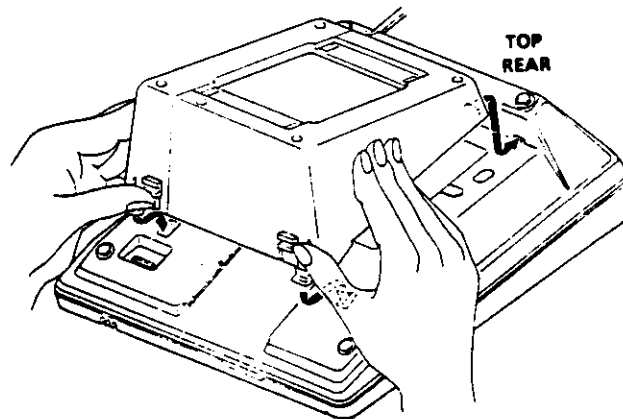

Figure 260-8

5. Slide both Plastic Mount Supports down as shown (See Figure 260-9).

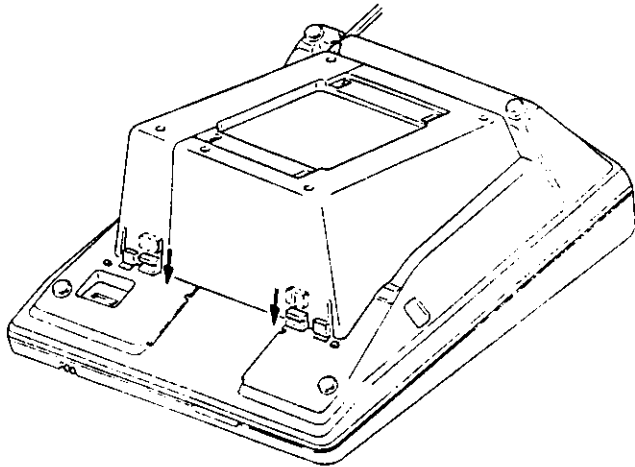

Figure 260-9

## SECTION 270 OPTIONAL EQUIPMENT CONNECTION

### 270.1 MUSIC ON HOLD

Provision has been made to allow connection of a locally provided external music source to provide Music On Hold for held calls.

Music source input is made using the phono jack MOH located on the TSW-E ETU. For music source's input level and impedance, refer to section 220 SPECIFICATIONS of this manual.

**NOTE:** In compliance with FCC Part 15 regulations, the following procedure must be implemented anytime a music on hold source is connected to this system.

- A. Make a slit on the cable insulation approximately one and one-half inches long, at a distance of 12 inches from the plug end, on the cable to be connected to the TSW-E MOH jack.

Take special care not to cut into the shield wire and inner wire insulation.

- B. Make a circular cut in the cable insulation at one end of the slit.

- C. Pull the cut insulation from the cable, so as to expose the shield for the length of the slit and cut the insulation off.

- D. Bend the cable near the middle of the exposed shield and separate the shield from the inner insulation in preparation for soldering, refer to figure 270-1.

- E. Obtain a 7 inch length of 20 ~ 24 AWG stranded wire and connect a ring-tongue type connector at one end.

- F. Strip a one-half inch length of insulation from the other end of the 7 inch wire. Solder this end to the shield previously exposed in step C, place tape around this connection to prevent the possibility of any unwanted short circuits.

- G. Connect the plug end into the TSW-E MOH jack.

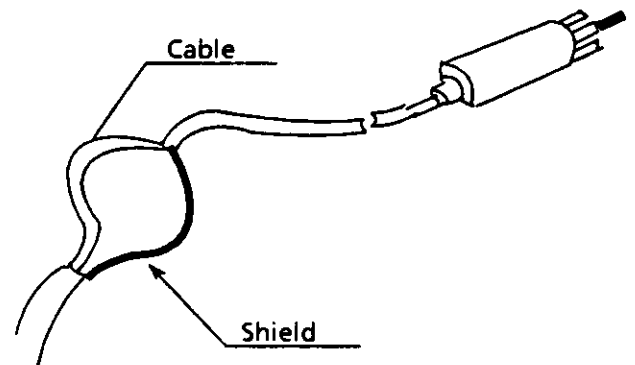

Figure 270-1 MOH Cable Shield Ground Exposed

- H. Route the cable down and to the right side of the CCU to avoid interference with the insertion and the removal of ETUs. Exit the other end of the cable at the right rear side of the CCU.

- I. The ring-tongue type connector installed in step E must be connected to the screw holding the PSE-AD-1 PSU. Refer to Figure 270-2 showing a suggested connection.

### 270.2 EXTERNAL PAGING

Audio output for external paging appears at the phono jack EP on the TSW-E ETU. Shielded audio

cable should be used for external paging audio connections.

The ECR-E ETU provides three contact closures, one per zone, for use in zone paging with meet-me answer. These contacts are labelled EPC 1A and EPC 1B through EPC 3A and EPC 3B. A maximum of one ECR-E ETU can be installed in a system providing a total of three paging zones.

It is necessary for the audio output to be connected to a locally provided amplifier and speaker(s), which are connected to the output of the amplifier via control relays, also locally provided. If the amplifier is a both way amplifier, two way paging is available. For connection information to a locally provided amplifier, refer to Table 230-1 and Figure 270-3. For external paging audio output level and impedance, refer to Section 220, SPECIFICATIONS of this manual.

With a locally provided amplifier, only one zone of paging and no background music, the ECR-E ETU is not required, since the ECR-E ETU is required to provide control of the external switching for applications with more than one zone of paging or background music.

When External Paging is answered by meet-me answer, the external paging audio circuit in the TSW-E ETU and the control circuits in the ECR-E ETU are released to allow access for another page.

You should not connect the amplifier output directly to the ECR-E ETU relay contacts. Crosstalk between single and/or outside lines and the paging circuit may occur.

### 270.3 BACKGROUND MUSIC

#### A. BGM Over External Speaker(s)

Background music over external speaker(s) is available if the ECR-E ETU is installed. A BGM source, an amplifier for BGM and external speaker(s) should be locally provided. For connection information, refer to Figure 270-3.

#### B. BGM Over Multiline Terminal Speakers

Background music over the speaker of Multiline Terminals is available if the ECR-E ETU is installed. A maximum of two BGM sources can be connected to the phono jacks, designated J2 and J3, provided on the ECR-E ETU. Shielded audio cable should be used for BGM audio connections. For BGM sources' output level and impedance, refer to Section 220 SPECIFICATIONS of this manual.

### 270.4 EXTERNAL TONE RINGING

External tone ringing is available when the ECR-E ETU is installed. The ECR-E ETU provides a continuous tone source for external tone ringing. The External tone can be set to any of four ring patterns. (See Section 340 of this manual). These patterns are selectable with DIP switch SW2 (refer to Table 270-1).

The audio output for external tone ringing appears at the phono jack J1 on the ECR-E ETU, its level is adjustable with the volume control VOL1 on the ECR-E ETU.

Shielded audio cable is required for this feature.

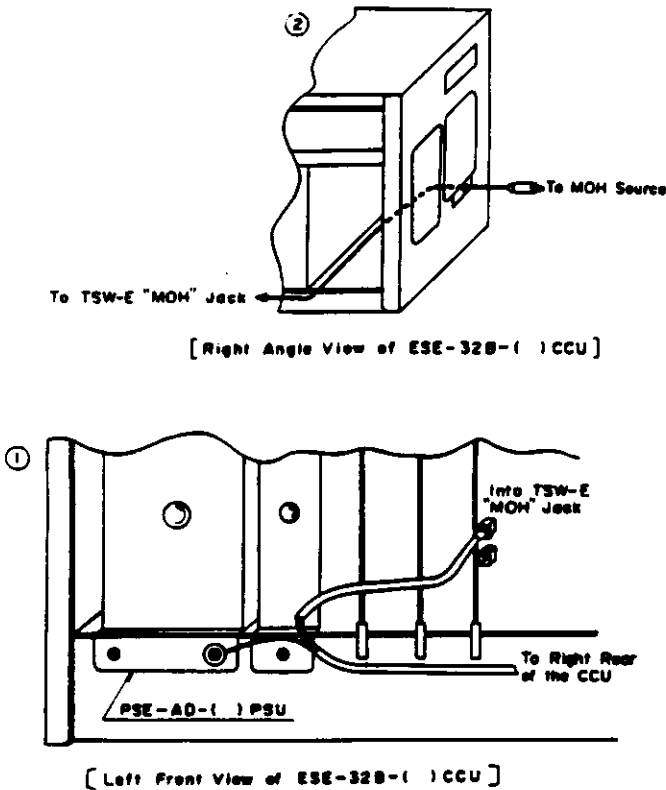

Figure 270-2 MOH Cable Shield Ground (Views of the ESE-32B-1 CCU)



Table 270-1 ECR-E Ringing Tone Sources

Tone #	Description	SW2 Assignment	
		Switch In Position 3	Switch In Position 4
1	Continous Ring Tone (480/606 Hz modulated by 16 Hz)	OFF	OFF
2	Continous Ring Tone (480/606 Hz modulated by 8 Hz)	OFF	ON
3	Ping-Pong Sound (1285 Hz/0.5 sec. ON, 1024 Hz/ 0.5 sec. ON, 5 sec. OFF)	ON	OFF
4	Continous Tone (1024 Hz)	ON	OFF

The ECR-E ETU provides four relay contact closures, one per external ring control circuit.

These four contacts can be accessed at the MDF (Refer to Table 230-1), which are labeled EPC4A/EPC4B through EPC6A/EPC6B, or on the ECR-E ETU, which are labeled A1/B1 through A4/B4 on the ECR-E ETU connectors CN1 and CN2.

Connection information of the locally provided amplifier and speakers is provided in Figure 270-4. Audio output specifications can be found in Section 220.

It is not recommended to connect the locally provided amplifier directly to the ECR-E ETU relay contacts. These contacts are not designed to accept AC signaling. Direct connection may also cause audio crosstalk between single line telephone, outside lines, and the tone ringing circuit.

#### 270.5 Night Chime

Night chime is available when the ECR-E ETU is installed. The ECR-E ETU contains three relay contacts for assignment of night chime. Night Chime is programmed on a Tenant basis. These contacts can be accessed at the MDF on the J block; labeling of these contacts are EPC4A/EPC4B through EPC6A/EPC6B (Refer to Table 230-1).

The contacts will provide a closure during CO ring, in the night mode, to a locally provided amplifier, speaker, and tone source. (See Figure 270-4).

#### 270.6 Modem Pooling Connection

##### 1. Equipment

For modem pooling connection, the following conditions must be complied with and the following equipment must also be made available:

A. The Electra MarkII system must provide a Multiline Terminal (with DTA-E unit installed) and a SLI-E( ) port to support each modem being installed.

B. Multiline Terminals with DTA-E units installed (other than those connected to modems) for data communication with outside DTE (Data Terminal Equipment).

C. For supporting the DTA-E unit, ESI-E(B) ETUs are required; to allow assignment of ESI-E(B) and SLI-E( ) ports for modem use, CPU-E(B) ETUs are required.

The Electra MarkII system provides paths for data connection and controls the setting and releasing of these paths. Software does not provide for support of protocol or conversion.

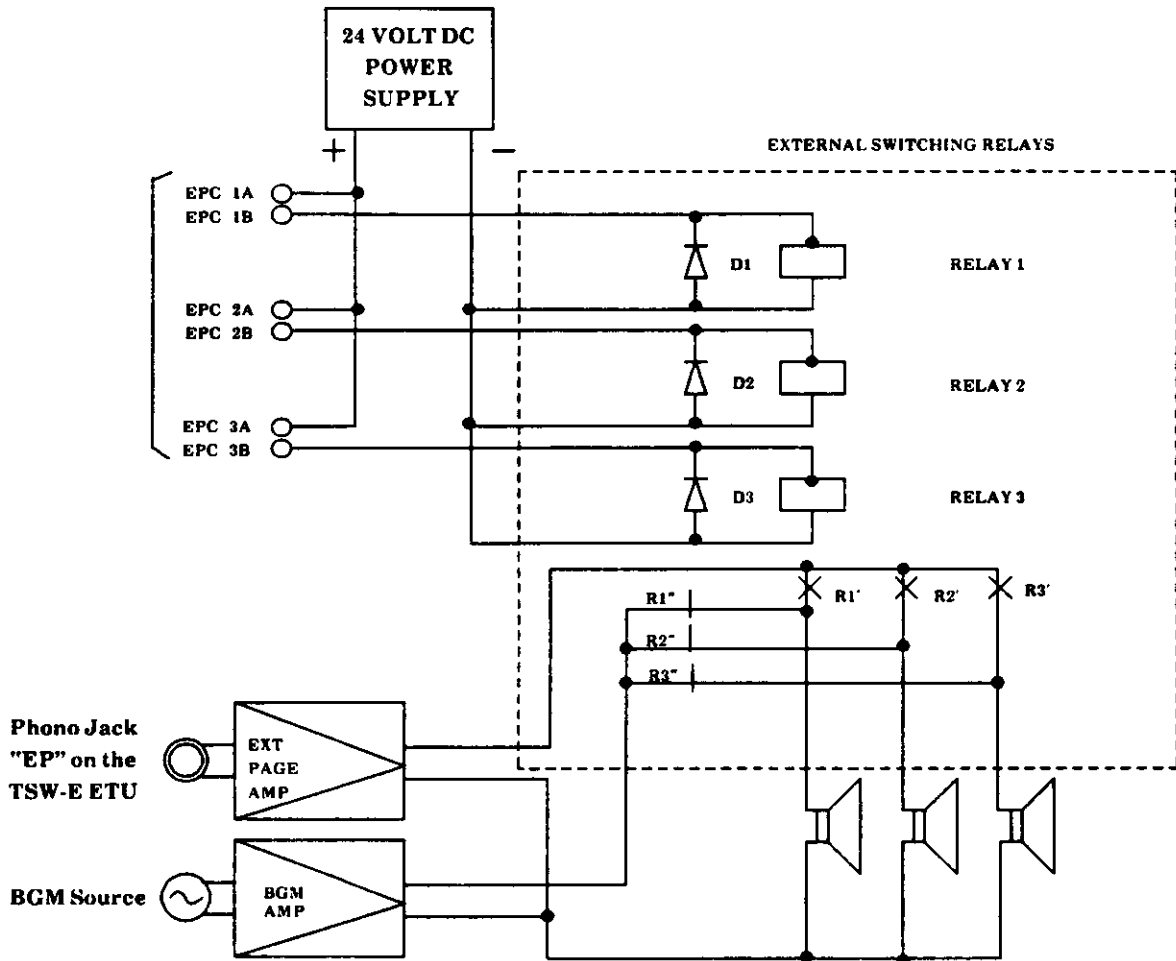

Note: Diodes D1 ~ D3 are IN4004 or equivalent  
 Figure 270-3 Connection of External Paging and External Background Music.

Figure 270-4 shows the modem pool connections, the data paths, DTEs and other equipment required for modem pool operation.

2. Installation

**NOTE:** Prior to connecting the modem to the DTA-E unit, unplug the Multiline Terminal (with DTA-E unit installed) line cord and ensure that the modem is not powered.

A. Locate a modem near a Multiline Terminal (with a DTA-E unit installed) already programmed for modem pooling.

B1. Installing Hayes compatible modems:

Use a modular plug ended line cord and connect the modem to an SLI-E( ) port programmed for

the same modem connection as in step A. Proceed to step C.

B2. Installing Non-Hayes compatible modems:

An ACU interface connector is provided with the modem. This connector must be wired to the single line tip and ring and to the PWR relay contact of the DTA-E. The interface connector is connected as shown in Table 270-2.

1. Remove the DTA-E unit from the Multiline Terminal being connected to the modem.. Plug in the PWR contact plug in the CN-2 socket of the DTA-E unit (See Figure 270-5).

2. Connect the other end of the PWR cable (red and white wires) to the TD (pin 5) and TDG (pin

- 25) of the ACU interface female connector provided with the modem.
  - 3. Connect the SLI tip and ring to be used for the modem, to pins 7 and 8 of the ACU interface female connector.
  - 4. Plug the female ACU interface connector into the male interface connector on the back of the modem.
- C. Set the baud rate of the modem to 300 or 1200, as required. This setting must be set to the same baud rate normally used by the distant modem when modem pooling.

- D. Set up the necessary parameters of the modem; refer to the instructions provided with the modem. If the modem is used for incoming modem pool use, the modem auto answer mode **must be enabled**.
- E. Plug the line cord into the Multiline Terminal and connect the AC/DC adaptor to the connector provided on the DTA-E unit.
- F. Power up the modem.
- G. Repeat the installation steps for all modems (up to 4 maximum) to be installed for use in modem pooling.
- H. Refer to Chapter 3, Programming, Memory Block 2B-7 to assign the modems to the single line port and Multiline Terminal (with DTA-E installed) port.

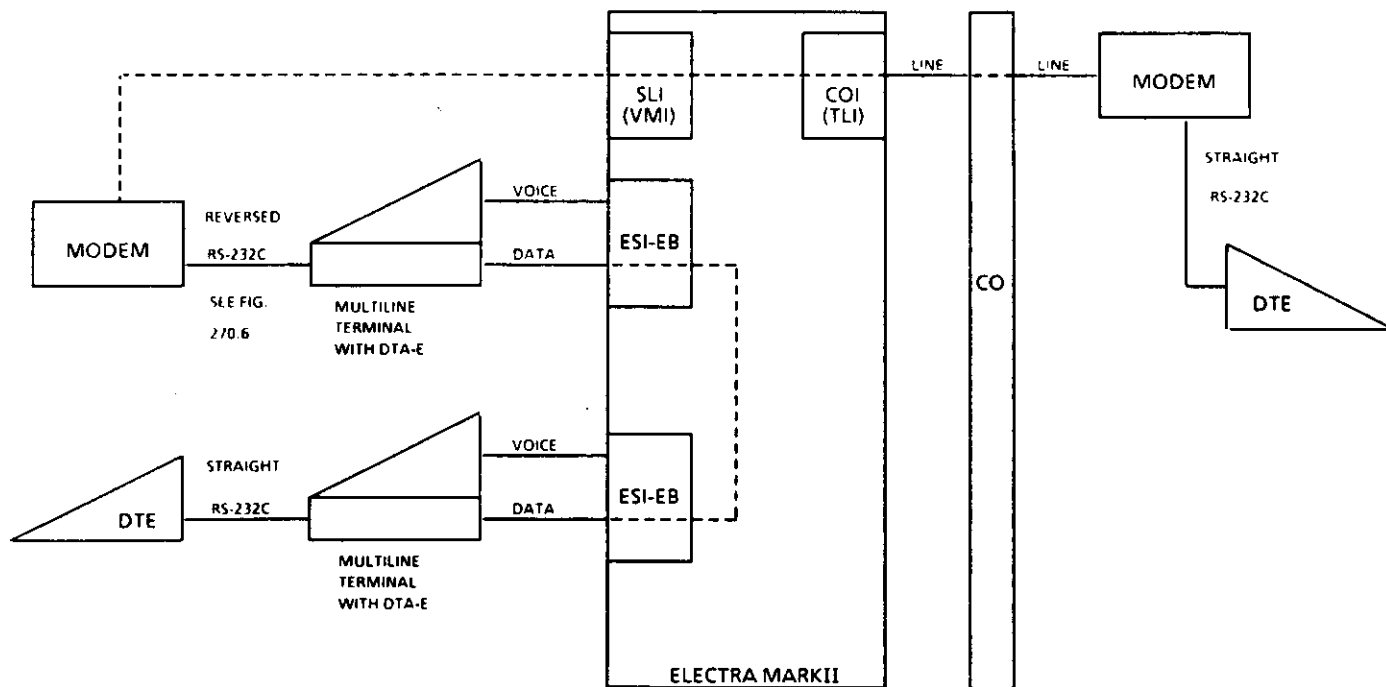
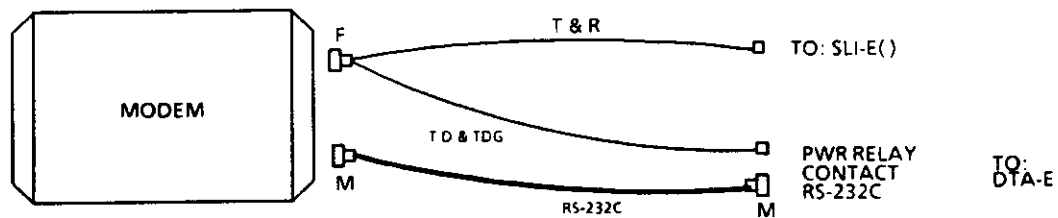

Figure 270-4 Modem Pooling Block Diagram

Table 270-2

EIA PIN NO.	SIGNAL DESIGNATION	SIGNAL DESIGNATION
1	L	TELEPHONE LINE LAMP CONTROL
2	MB1	MAKE BUSY RELAY CONTACTS IN MODEM
3	MB	MAKE BUSY RELAY CONTACTS IN MODEM
4	LG	GROUND RETURN FOR LINE LAMP CIRCUIT
5	TD	TALK/DATA SWITCH CONTACTS IN TELEPHONE (WITH TDG) (POWER RELAY CONTACT)
7	T	TELEPHONE LINE TIP
8	R	TELEPHONE LINE RING
12	RD	RING DETECT CONTACTS (TO GROUND) IN MODEM
14	C	DATA MODE CONTACTS (TO GROUND) IN MODEM
16	D1	DATA MODE CONTACTS (TO GROUND) FROM ACU
21	T1	TELEPHONE SET TIP
22	R1	TELEPHONE SET RING
23	A	CONTACT CLOSURE INDICATING THAT MODEM OR TELEPHONE IS HOLDING THE LINE
24	A1	CONTACT CLOSURE INDICATING THAT MODEM OR TELEPHONE IS HOLDING THE LINE
25	TDG	GROUND RETURN FOR TD SWITCH (SEE PIN 5) (POWER RELAY CONTACT)



F: 25 PIN FEMALE CONNECTOR  
 M: 25 PIN MALE CONNECTOR

Figure 270-5 Data Set Modem (Non Hayes Compatible Modem)  
 Telephone or ACU Interface

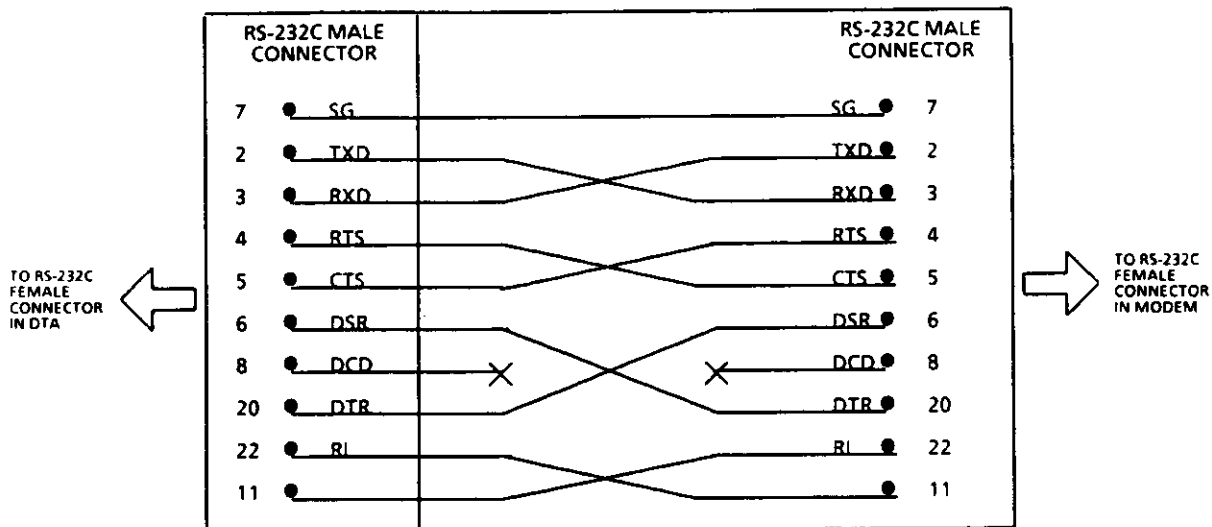

CABLE LENGTH: 50 feet (15 m) max.

CABLE TYPE Twisted pair shielded RS-232C cross cable with RS-232C male connectors on both ends.

Figure 270-6 Wiring Connections of RS-232C Cross Cable for Connecting a Modem to a DTA-E unit.



# **CHAPTER 3**

# **PROGRAMMING**





## CHAPTER 3 PROGRAMMING

TABLE OF CONTENTS			MEMORY ASSIGNMENT BLOCK	PAGE
<b>SECTION</b>	<b>DESCRIPTION</b>	<b>PAGE</b>		
<b>310</b>	<b>General</b>	300-1	<b>1E- Station Assignment</b>	
<b>320</b>	<b>How to Use This Chapter</b>	300-1	1 Terminal Exchange	300-50
<b>330</b>	<b>Resident System Default Values</b>	300-3	2 Terminal Add Port	300-52
<b>340</b>	<b>System Programming Data Sheets</b>	300-10	3 Terminal Busy Assignment	300-54
			4 Terminal/ Telephone Information	300-56
			5 Port Information	300-58
			6 Telephone Number Exchange	300-60
			7 Telephone Number Change	300-62
<b>MEMORY ASSIGNMENT BLOCK</b>	<b>PAGE</b>		<b>2A- System Feature 1</b>	
<b>1A- Line Key Assignment</b>	300-10		1 Programming Terminal	300-64
<b>1B- Ringing Assignment</b>	300-12		2 Speed Dial Tenant Assignment	300-66
<b>1C- DSS/BLF Button Assignment</b>			3 Speed Dial Override Assignment	300-68
1 DSS/BLF to Attendant Assignment	300-14		4 Incoming Prime Line Pickup	300-70
2 BLF Terminal Assignment	300-16		5 CO * and # as 1st. Digit Assignment	300-72
3 DSS/BLF Button Assignment	300-18		6 SMDR Incoming Print	300-74
4 DSS/BLF Flexible Function Key Assignment	300-20		7 Internal All Call	300-76
5 DSS to CO Add-On Module Assignment	300-22		8 Account Code Digit	300-78
6 CO Add-On Module Line Key Assignment	300-24		9 PBX Outgoing Code	300-80
7 CO Add-On Module Day Ring Assignment	300-26		10 Tie Line Digit Restriction	300-82
8 CO Add-On Module Night Ring Assignment	300-28		<b>2B- System Feature 2</b>	
<b>1D- Station Feature</b>			1 Modem Pooling / Terminal Keyboard Dialing	300-84
1 Prime / Ringing Line Assignment	300-30		2 Allow Forward Override	300-86
2 Data Services Assignment	300-32		3 DIT Trunk to Tenant Assignment	300-88
3 User Program Assignment	300-34		4 DIT /ANA Assignment	300-90
4 Trunk Group Incoming Restriction	300-36		5 LCR 1 + Dialing Assignment	300-92
5 Trunk Group Outgoing Restriction	300-38		6 LCR Local Call Override Assignment	300-94
6 Code Restriction Table Access	300-40		7 Modem Pool Assignments	300-96
7 Class of Service Assignment	300-42		8 VMI Assignment	300-98
8 Terminal to Attendant Assignment	300-44		9 LCR Bypass Assignment	300-100
9 Terminal to Paging Zone Assignment	300-46		10 Recall Key Operation for Tie Line	300-102
10 Call Pickup Group Assignment	300-48		<b>2C- System Group</b>	
			1 Trunk to Trunk Group Assignment	300-104
			2 Trunk Group to Tenant Assignment	300-106
			3 Trunk Group to Access Code Group	300-108
			4 Voice Mail Hunt Group Assignment	300-110
			5 Delay Announcement Assignment	300-112

MEMORY ASSIGNMENT BLOCK	PAGE	MEMORY ASSIGNMENT BLOCK	PAGE
6 Uniform Dial to Trunk Access Code Group	300-114	3D-	
7 Night Chime Assignment	300-116	1 First Initialization	300-164
8 External Ringing Control Assignment	300-118	2 Second Initialization	300-166
9 ECR Relay Assignment	300-120	3 Slot Initialization	300-168
10 Virtual Extension Assignment	300-122	4 Terminal (TEL, DSS) Initialization	300-170
2D- <i>System Time Base</i>		3E- <i>System Restriction Table</i>	
1 Time Base Assignment I	300-124	1 Regional Dialing Assignment	300-172
2 Time Base Assignment II	300-126	2 1 + Dialing Assignment	300-174
3 Time Base Assignment III	300-128	3 Rejection Code Assignment	300-176
2E-1 <i>System Access Code Assignment</i>	300-130	4 System Allow / Deny Assignment	300-178
System Feature (Access) Code List	300-132	5 Table Allow / Deny	300-180
3A- <i>System Attendant</i>		6 Trunk Group to Code Table Assignment	300-182
2 Attendant 3rd. and 4th. Assignment	300-134	7 Table - OCC Flag Assignment	300-184
3 Attendant Overflow Assignment	300-136	8 Table - OCC Code Assignment	300-186
4 Attendant to Tenant Assignment	300-138	9 Restriction Table Code Assignment	300-188
3B- <i>System 2 Feature 1</i>		10 Special Code Assignment	300-190
1 First Ring Pattern Assignment	300-140	4A-	
2 Centrex Ringing Assignment	300-142	1 System All Busy Restore Assignment	300-192
3 Forced Account Code Digit Assignment	300-144	2 System All Busy Out Assignment	300-194
4 RAA SLT Assignment	300-146	4B- <i>Card Mode</i>	
5 Station Hunting Pilot Number Assignment	300-148	1 COI-I Initialized Values	300-196
6 Station to Hunt Group Assignment	300-150	2 COI-II Initialized Values	300-198
7 Station Hunt Type Assignment	300-152	3 SLI Common Values	300-200
8 Station Hunt Group Assignment	300-154	4 ESI-EB Data and Second Voice Path Assignment	300-202
9 Trunk Group to Line Pool Group Assignment	300-156	6 COI-III Initialized Values	300-204
10 Line Pool Group Auto Extension Assignment	300-158	7 COI-IV Initialized Values Programming Parameters	300-206
3C- <i>System Name Assignment</i>		8 VMI Initialize 1 Assignment	300-208
1 Telephone Name Assignment	300-160	9 VMI Initialize 2 Assignment	300-210
2 Trunk Group Name Assignment	300-162	4C- <i>Card Interface</i>	
		1 Card Interface Slot Assignment	300-212
		2 Interface Slot Busy Out Assignment	300-214

<b>MEMORY ASSIGNMENT BLOCK</b>	<b>PAGE</b>
<b>4E- TLI Programming</b>	
1 TLI Line Type Assignment	300-216
2 TLI Dial Tone Assignment	300-218
3 TLI Digit Add/Delete Code Assignment	300-220
4 TLI-I Initialized Values	300-222
5 TLI-II Initialized Values	300-224
6 TLI-III Initialized Values	300-226
7 TLI-IV Initialized Values	300-228
8 TLI-V Initialized Values	300-230
9 Tandem Port to Hunt Group Assignment	300-232
10 Trunk Group to Tandem Hunt Group Assignment	300-234
<b>5A- Station Copy Assignment</b>	<b>300-236</b>
<b>5B-</b>	
1 CPU Initial History	300-238
2 System Program Check	300-240
3 Interface Slot Check	300-242
4 Terminal Check	300-244
5 Software/Hardware Slot Status	300-246
6 Software/Hardware Terminal Status	300-248
<b>5C-</b>	
1 System Data Last Change	300-250
2 Data Dump	300-252
<b>350 Function Timer Charts</b>	<b>300-254</b>
<b>360 Code/Call Restriction</b>	
360.1 General	300-257
360.2 1 + Dialing Area	300-258
360.3 Direct Dial Area	300-259
360.4 OCC	300-259
360.5 Puerto Rico	300-260
<b>370 Job Specification Sheets</b>	<b>300-266</b>



## 310 GENERAL

The Electra MarkII is a stored program controlled system. Upon initial power up, the system's CPU-E( ) ETU scans each of the possible interface slots (up to thirty two) to determine the hardware configuration. The system stores this information as well as system default values in memory. *This area of memory is referred to as the resident system program.* After the initial power up, a trained technician can change the resident system program so that the Electra MarkII can meet the particular needs of the customer. Samples of job specification sheets are provided in this chapter. These sheets help organize each customer's programming needs, and should be used and retained on the job site as well as in the office.

**NOTE:** Before attempting any programming of the Electra MarkII System, it is important that the battery on the CPU-E be checked to make sure it is on. Failure to do so may result in loss of system programming.

## 320 HOW TO USE THIS CHAPTER

Chapter 3, of this installation manual, provides all the necessary information for programming the Electra MarkII system. The chapter is divided into the following sections:

- 310 General
- 320 How To Use This Chapter
- 330 Resident System Default Values
- 340 System Programming
- 350 Function Timer Charts
- 360 Toll/Code Restrictions
- 370 Job Specifications

This **HOW TO USE CHAPTER** provides the reader directions and recommendations for using Chapter 3.

## SYSTEM PROGRAMMING

Section 340 describes, in detail, each of the programming areas in the five memory blocks. This section is to be used as a guide when programming. For each programming area, Section 340 provides two reference pages; the first page provides step by step instructions as well as all display messages, while programming. The second page supplies supplement charts and notes to help explain the program instructions; it also explains the use of each function and line key as it pertains to the particular program area.

## FUNCTION TIMER CHARTS

Section 350 is provided as a quick cross reference for all of the system's timers, which can be set through programming. This section provides a full description of each timer, explaining their purpose and function within the system, as well as their default values, range, and the memory block area it is assigned.

## TOLL/CODE RESTRICTIONS

Section 360 discusses the code restriction plan designed into the Electra MarkII system. Initially this section describes the code restriction tables and their general use when dial restricting stations. Discussion is then extended to the following dialing areas:

- A. 1 + dialing areas
- B. Direct Dialing areas
- C. OCC, Equal Access
- D. Puerto Rico area

Flow charts are provided for each dialing area listed. These flow charts provide the reader with a clear step by step understanding of how each type of restriction is handled. This is all the information needed to have a complete understanding of the Code Restriction Plan. Each flow chart is provided with an outline explanation of the steps in the flow chart to further simplify the discussion.

## JOB SPECIFICATION SHEETS

Section 370 contains a sample of the job specification sheets. These sheets contain all the system programming values and configurations required for an installation.

During the initial stages of system planning, the job specification sheets are necessary for collecting information to enable an accurate costing and installation of an Electra MarkII system. The customer information, as collected by the salesperson (or installation supervisor), is recorded onto the job specification sheets. The order of these sheets are presented in the logical order of the memory blocks (as provided in Section 340), to make the system programming as easy and efficient as possible.

The first group of sheets are used for entering the station features; line button assignments, for Multiline Terminal and DSS/BLF consoles, as well as dialing restrictions and class of service (as required by the customer) are listed here. The second group of sheets are for assigning system features; assignment of trunk groups (for specialized service) and the assignment of system attendants, for example, are

completed in this group. The last group of sheets are used for documenting all of the necessary information about the system configuration. This section is very useful for service technicians who need to keep track of adds, moves, changes, and in some cases for troubleshooting.

Each job specification sheet additionally includes a brief description sheet explaining all the chart entries. These job sheets must be kept up to date, and LEFT ON THE JOB SITE, to provide technicians with all the necessary information needed to provide the customer with proper, and professional service. A duplicate copy of the job spec sheets should also be maintained at the servicing office, in the customer's file for reference.

### ENTERING THE PROGRAMMING MODE AND THE SELECTION OF MEMORY BLOCKS

In order to use the sections just discussed, a brief description of how to enter the programming mode and the selection of memory block areas is necessary.

Initially, programming of the Resident System Program can be accomplished by either of two ETE-16D-( ) Multiline Terminals. These station positions are automatically assigned to the two lowest ESI-E( ) ports in the system. Although these positions are fixed, a third programming position can be assigned to any ESI-E( ) port in the system, that supports an ETE-16D-( ) Multiline Terminal. For an RAA-E unit, a fourth ESI-E( ) port can be assigned in Memory Block 1E2.

The first step, when entering any area of programming, is to place the programming station into the OFF-LINE mode.

#### TO GO OFF-LINE

- A. Depress L16 (Primary Extension Line)
- B. Depress the Speaker Key (receive dial tone)
- C. Dial #, \*, 0 in sequence

After these three steps, the LCD on the Multiline Terminal will be as shown. The display (X.XX) is the software level of the CPU-E( )

O	F	-	L	I	N	E	(	X	.	X	X	)
P	R	O	G	R	A	M	M	O	D	E		

While the programming terminal is OFF-LINE, it cannot be signaled by any station in the system. Only one programming terminal can be OFF LINE at one time.

The next step is to select the area in the system memory blocks which correspond to the feature, or function, to be programmed. A memory block index has been provided to help the programmer locate the area needed. Selection of a memory block location is done by depressing the Multiline Terminal's Feature Access keys in a predetermined sequence. The ETE-16D-( ) Multiline Terminal has twenty Feature Access keys, F1 through F20, which are used for this purpose. The Resident System Program is setup into five memory block areas. Feature Access keys F1 through F5 are used to select each memory block area, 1 to 5 respectively.

Within each memory block area, memory feature sections are grouped by letter designation, for example, memory block 1 is divided into five sections:

- A. Line Key Assignment
- B. Ringing Assignment
- C. DSS/BLF and CO Add-On Module Button Assignments
- D. Station Feature
- E. Station Assignment

These sections, defined by letters A through E, are accessed by depressing Feature Access keys F6 to F10 respectively.

Once a memory block area and memory feature section has been chosen, selection of Feature Access keys F11 to F20 are used to enter a particular memory feature item.

	MEMORY BLOCK	MEMORY FEATURE SECTION	MEMORY FEATURE ITEM
DESIGNATION	1 through 5	A through E	1 through 10
FEATURE KEY	F1 through F5	F6 through F10	F11 through F20

**SECTION 330 RESIDENT SYSTEM DEFAULT VALUES**

MEMORY BLOCK	FUNCTION	DEFAULT VALUES						
1A	Line Key Assignment	<ul style="list-style-type: none"> <li>● 6 Line Multiline Terminal               <ul style="list-style-type: none"> <li>Line keys 1 ~ 5 = CO/PBX lines 1 ~ 5</li> <li>Line key 6 = Primary extension</li> </ul> </li> <li>● 16 Line Multiline Terminal               <ul style="list-style-type: none"> <li>Line keys 1 ~ 15 = CO/PBX lines 1 ~ 15</li> <li>Line key 16 = Primary extension</li> </ul> </li> </ul>						
1B	Ringling Assignment (Day and Night Mode)	CO/PBX lines 1 ~ 15 ring at attendants 1 and 2						
1C1	DSS/BLF to Attendant Assignment	DSS/BLF Consoles 1 and 2 assigned to Attendants 1 and 2 respectively. No other DSS/BLF console assigned to any attendant						
1C2	BLF Terminal Assignment	No ETE-16D-( ) Multiline Terminals are assigned the BLF feature						
1C3	DSS Button Assignment	DSS buttons 1 ~ 30 are assigned to stations 100 ~ 129 respectively when 30 or more stations are installed on DSS/BLF consoles 1 and 2. With less than 30 stations installed, the unused keys are assigned vacant.						
1C4	DSS/BLF Flexible Function Key Assignment	<table style="width: 100%; border: none;"> <tr> <td style="width: 80%;">Function Key 1: Message wait</td> <td>On DSS/BLF</td> </tr> <tr> <td>Function Key 2: Night transfer</td> <td>Consoles</td> </tr> <tr> <td>Function Key 3: Transfer</td> <td>1 and 2</td> </tr> </table>	Function Key 1: Message wait	On DSS/BLF	Function Key 2: Night transfer	Consoles	Function Key 3: Transfer	1 and 2
Function Key 1: Message wait	On DSS/BLF							
Function Key 2: Night transfer	Consoles							
Function Key 3: Transfer	1 and 2							
1C5	DSS to CO Add-On Module Assignment	No DSS/BLF units are assigned as CO Add-On Modules						
1C6	CO Add-On Module Line Key Assignment	Not Assigned						
1C7	CO Add-On Module Day Mode Ring Assignment	Not Assigned						
1C8	CO Add-On Module Night Mode Ring Assignment	Not Assigned						
1D1	Prime/Ringing Line Assignment	Prime Line to Primary extension No ringing line preference is assigned on all Multiline Terminals						
1D2	Data Service Assignment	No auto answer, auto release						
1D3	User Program Assignment	Off-Hook Ringing to Attendants 1 and 2 only <table style="width: 100%; border: none;"> <tr> <td style="width: 80%;">Voice/Tone Signaling</td> <td>- Voice</td> </tr> <tr> <td>Ringling Tone</td> <td>- Tone # 1</td> </tr> </table>	Voice/Tone Signaling	- Voice	Ringling Tone	- Tone # 1		
Voice/Tone Signaling	- Voice							
Ringling Tone	- Tone # 1							
1D4	Trunk Group Incoming Restriction	No station is restricted on all trunk groups						
1D5	Trunk Group Outgoing Restriction	No station is restricted on all trunk groups						
1D6	Code Restriction Table Access	No code restriction table is assigned to any station						

MEMORY BLOCK	FUNCTION	DEFAULT VALUES
1D7	Class of Service Assignment	<ul style="list-style-type: none"> <li>● Originating Camp-On - All stations are allowed</li> <li>● Receiving Camp-On - All stations are allowed</li> <li>● Call Forward - All stations are allowed</li> <li>● Operator Restriction - No station is restricted</li> <li>● Data Line Security - No station is assigned</li> <li>● Station Lockout - No station is allowed</li> <li>● Page Access - All stations are allowed</li> <li>● LCR Priority - No station is assigned to LCR</li> <li>● Trunk to Trunk TRF - All stations are denied</li> <li>● Account Code - Forced Verified - All stations are denied</li> </ul>
1D8	Terminal to Attendant Assignment	All stations are assigned to attendant 1
1D9	Terminal to Paging Zone Assignment	No station is assigned to any zone
1D10	Call Pickup Group Assignment	No station is assigned to any call pickup group
1E1	Terminal Exchange	Not assigned
1E2	Terminal Add Port	Depends on system configuration
1E3	Terminal Busy Assignment	Not assigned; not busied out
1E4	Terminal/Telephone Information	Depends on system configuration
1E5	Port Information	Hardware & software: yes for installed equipment
1E6	Telephone Number Exchange	Not assigned
1E7	Telephone Number Change	Not assigned
2A1	Programming Terminal	Attendants 1 and 2: Fixed programming position <i>Attendant terminal must be ETE-16D-( )</i> . Third programming station is not assigned
2A2	Speed Dial Tenant Assignment	All system speed dial buffers (20 ~ 99) are assigned to tenant 1
2A3	Speed Dial Override Assignment	All system speed dial buffers override code restriction
2A4	Incoming Prime Line Pickup	Disallow
2A5	CO * and # as 1st. Digit Assignment	Disallow
2A6	SMDR Incoming Print	Disallow
2A7	Internal All Call	Disallow
2A8	Account Code Digit	10 digits
2A9	PBX Outgoing Code	Code 1 - 9 Code 2 - Not assigned
2A10	Tie Line Digit Restriction	No restriction
2B1	Modem Pooling PC Keyboard Dialing	Disallow
2B2	Allow Forward Override	Allow



MEMORY BLOCK	FUNCTION	DEFAULT VALUES
2B3	DIT Trunk to Tenant Assignment	All DIT trunks assigned to tenant 1
2B4	DIT Assignment	No Assignment
2B5	LCR 1 + Dialing	Not 1 + dial area
2B6	LCR Local Call Override	Local calls override LCR
2B7	Modem Pool Assignment	No assignment
2B8	VMI Assignment	All VMI ports are assigned for Voice Mail DTMF automatic dial is not applied to any VMI port
2B9	LCR Bypass Assignment	All trunk access code groups do not bypass LCR
2B10	Recall Key for Tie Lines	Extension dial tone
2C1	Trunk to Trunk Group Assignment	All CO trunks are assigned to trunk group 1. All Tie lines are assigned to trunk group 2
2C2	Trunk Group to Tenant Assignment	All trunk groups are assigned to tenant 1
2C3	Trunk Group to Access Code Group Assignment.	All CO trunk groups are assigned access code 9 (Trunk item code group 1) except for trunk group 2, which is assigned access code 8 (Trunk item group 2)
2C4	Voice Mail Hunt Group Assignment	No extension number is assigned for voice mail hunt group
2C5	Delay Announcement Assignment	Not assigned
2C6	Uniform Dial to Trunk Access Code Group	Trunk access code group 2
2C7	Night Chime Assignment	No Night Chime assigned to any trunk group
2C8	External Ringing Control	No External Ringing Control Relay assigned to any trunk group
2C9	ECR Relay Assignment	Relay #1 - External Paging Zone 1 (Fixed) Relay #2 - External Paging Zone 2 (Fixed) Relay #3 - External Paging Zone 3 (Fixed) Relays #4~10 are not assigned.
2C10	Virtual Extension Assignment	Virtual extensions 01 ~ 48 are assigned to extensions 200 ~ 247
2D1	Time Base Assignment I	See Job Spec 2D1 this chapter
2D2	Time Base Assignment II	See Job Spec 2D2 this chapter
2D3	Time Base Assignment III	See Job Spec 2D3 this chapter
2E1	System Access Code Assignment	See memory block 2E1 this chapter
3A2	Attendant 3rd and 4th Assignment	Not assigned
3A3	Attendant Overflow Assignment	Not assigned

MEMORY BLOCK	FUNCTION	DEFAULT VALUES
3A4	Attendant to Tenant Assignment	Attendants 1 & 2 are assigned to tenant 1 Attendant 1 assignment is fixed
3B1	First Ring Pattern Assignment	Normal CO ringing (2 secs. ON, 4 secs. OFF)
3B2	Centrex Ringing Assignment	Normal CO ringing (2 secs. ON, 4 secs. OFF)
3B3	Forced Account Code Digit Assignment	10 digits
3B4	RAA SLT Assignment	None
3B5	Station Hunting Pilot Number Assignment	None
3B6	Station to Hunt Group Assignment	No extension number for hunt group number (1~8)
3B7	Station Hunt Type Assignment	Linear hunting
3B8	Station Hunt group Assignment	No FWD destination for hunt group number (1~8)
3B9	Trunk group to Line Pool Group Assignment	None
3B10	Line Pool Group Auto Extension Assignment	Pool auto, extension is only assigned for primary extension
3C1	Telephone Name Assignment	Not assigned
3C2	Trunk Group Name Assignment	CO CALL
3D1	First Initialization	Not applicable
3D2	Second Initialization	Not applicable
3D3	Slot Initialization	Not applicable
3D4	Terminal (TEL, DSS) Initialization	Not applicable
3E1	Regional Dialing Assignment	Standard dial area
3E2	1 + Dialing Assignment	All trunk groups are not assigned 1 + dialing
3E3	Rejection Code Assignment	No rejection code is assigned to code 1 ~ 4
3E4	System Allow/Deny Assignment	Allow
3E5	Table Allow/Deny Assignment	Deny
3E6	Trunk Group to Code Table Assignment	No trunk group is assigned to any code table
3E7	Table- OCC Flag Assignment	No OCC flag is assigned to any code table
3E8	Table- OCC Code Assignment	No OCC code is assigned to any code table
3E9	Restriction Table Code Assignment	No area/office code is assigned to any code table
3E10	Special Code Assignment	No special code is assigned

MEMORY BLOCK	FUNCTION	DEFAULT VALUES
4A1	System All Busy Restore Assignment	System not busied out
4A2	System All Busy Out Assignment	System not busied out
4B1	COI-I Initialized Values	DTMF; CO; No disconnect signal from CO: DTMF duration = 110 mS. Hookflash 1.5 seconds
4B2	COI-II Initialized Values	Hit Protection Time = 350 mS.; Disconnect Recognition Time = 300 mS. Pause = 1 sec. Interdigit time = 70 mS.
4B3	SLI Common Values	HFS = 300 mS.; HFE = 1 sec.; BP = 300 mS.
4B4	ESI-EB Data and Second Voice Path Assignment	All ESI-EB paths are assigned Dual Path
4B6	COI-III Initialized Values	DTMF; CO; No disconnect signal from CO: DTMF duration = 110 mS. Hookflash 1.5 seconds
4B7	COI-IV Initialized Values Programming Parameters	Hit Protection Time = 350 mS.; Disconnect Recognition Time = 300 mS. Pause = 1 sec. Interdigit time = 70 mS.
4B8	VMI Initialize 1 Assignment	HFS = 300 mS.; HFE = 1 sec.; BP = 300 mS.
4B9	VMI Initialize 2 Assignment	Interdigit Interval Time = 70 mS.; DTMF duration = 110mS.; Pause Time = 1 Sec.; Disconnect Time = 1.5 Sec.
4C1	Card Interface Slot Assignment	Depends on system configuration
4C2	Interface Slot Busy Out Assignment	No slot busied out
4E1	TLI Line Type Assignment	Second dial tone
4E2	TLI Dial Tone Assignment	Send dial tone to outside
4E3	TLI Digit Add/Delete Code Assignment	Delete digits: 0 Additional digits: NO
4E4	TLI-I Initialized Values	Pause Time = 1 Sec.; Pre-pause Time = 3 Sec.; CO Answer = 520 mS.; CO Release = 520 mS.
4E5	TLI-II Initialized Values	Wink Detect = 520 mS.; Delay Detect = 120 mS.; Loop Off-Guard = 2 Sec.; Wink = 180 mS.
4E6	TLI-III Initialized Values	With Wink Delay Signal Timeout = 7 Sec.; Outgoing Guard = 3 Sec.
4E7	TLI-IV Initialized Values	2dB loss to each path
4E8	TLI-V Initialized Values	DP (Receive and Send) Interdigit Interval Time = 70mS. DTMF duration = 110mS.
4E9	Tandem Port to Hunt Group Assignment	Not Assigned.
4E10	Trunk Group to Tandem Hunt Group Assignment	All trunk groups assigned to Tandem Hunt Group 1.

MEMORY BLOCK	FUNCTION	DEFAULT VALUES
5A	Station Copy Assignment	Not applicable
5B1	CPU Initial History	Not applicable
5B2	System Program Check	Not applicable
5B3	Interface Slot Check	Not applicable
5B4	Terminal Check	Not applicable
5B5	Software/Hardware Slot Status	Not applicable
5B6	Software/Hardware Terminal Status	Not applicable
5C1	System Data Last Change	Not applicable
5C2	Data Dump	Not applicable



**SECTION 340 SYSTEM PROGRAMMING DATA SHEETS  
 MEMORY BLOCK 1A - LINE KEY ASSIGNMENT**

OPERATION ← AND → DISPLAY

1. Go off line.

		O	F	F	-	L	I	N	E		(	X	.	X	X	)
		P	R	O	G	R	A	M		M	O	D	E			

2. Depress F1.

T	E	R	M	I	N	A	L									

3. Depress F6.

4. Dial station number being assigned.  
 Example = Station 104.

L	I	N	E		K	E	Y		A	S	S	I	G	N		
T	E	L	?	?	?											

5. Depress line button to be assigned (L1~L15). (See Notes 1 and 2).

L	K		A	S	G	N			T	E	L	1	0	4		
S	E	L	E	C	T		L	I	N	E		K	E	Y		

6. Depress correct function key to select line type.

CO line F11 

L	K		A	S	G	N			T	E	L	1	0	4		
C	O	-	?	?												

 All CPU levels.

Pool F12 

L	K		A	S	G	N			T	E	L	1	0	4		
L	I	N	E		P	O	O	L		G	R	P	-	?		

 CPU-EB3 or higher.

Extension F14 

L	K		A	S	G	N			T	E	L	1	0	4		
E	X	T	E	N	S	I	O	N	-	?	?	?				

 All CPU levels.

Data Transmit F16 

L	K		A	S	G	N			T	E	L	1	0	4		
D	A	T	A		T	R	A	N	S	M	I	T				

 CPU-EB or higher.

Data Receive F17 

L	K		A	S	G	N			T	E	L	1	0	4		
D	A	T	A		R	E	C	E	I	V	E					

 CPU-EB or higher.

Save & Repeat F18 

L	K		A	S	G	N			T	E	L	1	0	4		
S	A	V	E	&	R	E	P	E	A	T	-	?	?			

 All CPU levels.

DND Position F20 

L	K		A	S	G	N			T	E	L	1	0	4		
D	N	D		P	O	S	I	T	I	O	N					

 All CPU levels.

or to make vacant CLEAR

L	K		A	S	G	N			T	E	L	1	0	4		
		V	A	C	A	N	T									

7. For the line type selected in step 6, enter the assigned number.

CO line 01~40 \*Extension 100~899  
 Save & Repeat 01~80 1000~8999  
 Line Pool Group 1 ~ 8

\*NOTE: Usable extension numbers depend on feature access codes used in the system.

(See Note 3)

8. Depress ENTER key.

9. Repeat steps 5 to 7 for all other assigned positions.

10. If more stations need programming, depress F/W or B/W until desired station number is displayed, then go to step 5.

11. When all stations are programmed, depress the SPKR key to go back on line.

**KEY FUNCTION (OFF LINE)**

<b>SPKR</b> - ON/OFF Line
<b>TEL #</b> - Select station to be assigned.
<b>F/W</b> (Forward) - Increment station number.
<b>CLEAR</b> - Vacant line assignment.
<b>ENTER</b> - Enter for each line assignment.
<b>B/W</b> (Backward) - Decrement station number.

**GUIDE TO FEATURE PROGRAMMING**

MEMORY BLOCK BEING PROGRAMMED	MEMORY BLOCK THAT MUST BE PROGRAMMED	MEMORY BLOCK THAT MAY HAVE TO BE PROGRAMMED
<b>1A</b>		1B, 1D2, 2E1
		2C10, 1E2
		3B9, 3B10

See Step 6 for CPU levels.

**NOTES:**

1. When programming appearances for a 6 button station, line buttons L1 ~ L5 should be selected on the programming station.
2. During step 4, if a non-assigned line position is selected, the display will show VACANT.
3. Line keys must be idle before an assignment change can be made.
4. Line key 6 is always the station's primary extension number (for ETE-6-( ) and ETE-6D-( ) Multiline Terminals).
5. Line key 16 is always the station's primary extension number (for ETE-16-( ), ETE-16D-( ) and ETE-16K-( ) Multiline Terminals).
6. Depression of the ENTER key causes the program to move to the next line key position to the right.

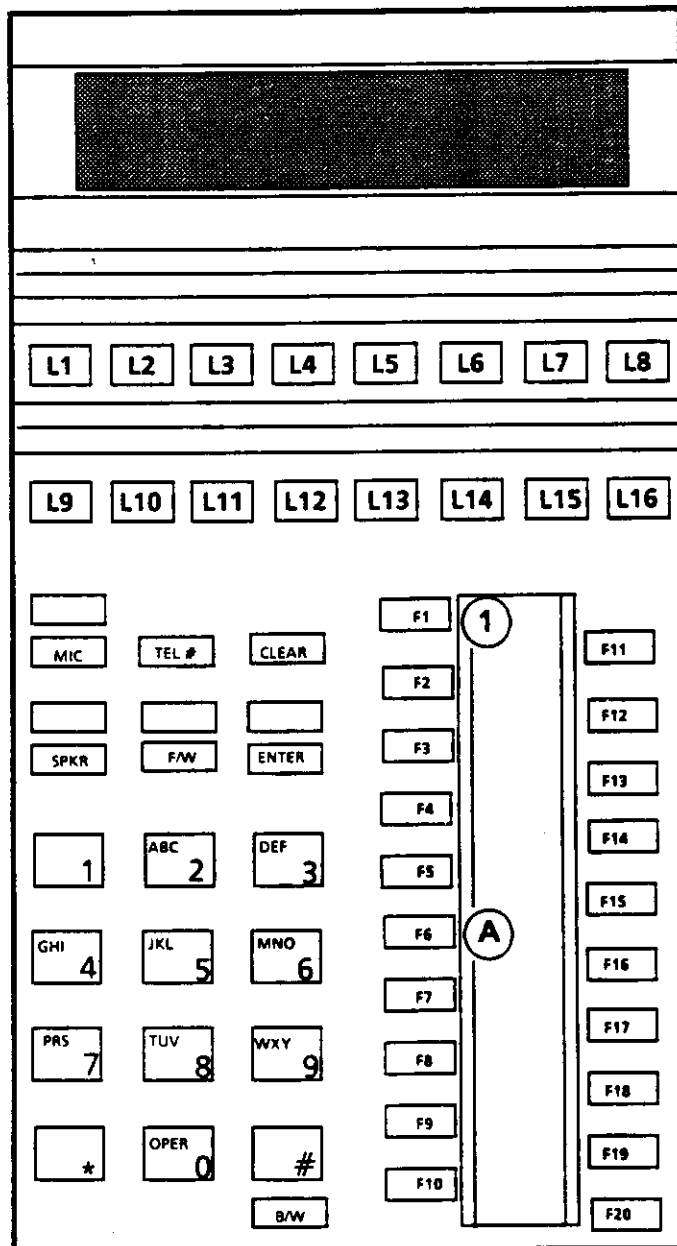

**GENERAL INFORMATION - LINE KEY ASSIGNMENT**

This area of memory is used to assign line key appearances of the Multiline Terminals in the system. Each line key appearance on each Multiline Terminal can be designated as one of the following (Other than PE):

- CO line (only one appearance of a particular number per terminal)
- Pooled Line (only one appearance of a particular number per terminal)
- Extension (only one appearance of a particular number per terminal)
- Data Transmit (only one appearance per terminal)
- Data Receive (only one appearance per terminal)
- Save and Repeat (No limitation, 80 S&R maximum per system)
- DND Position (only one per terminal)
- VACANT

## MEMORY BLOCK 1B - RINGING ASSIGNMENT

OPERATION ← AND → DISPLAY

1. Go off line.

O	F	F	-	L	I	N	E		(	X	.	X	X	)
P	R	O	G	R	A	M		M	O	D	E			

2. Depress F1.

T	E	R	M	I	N	A	L							

3. Depress F7.

R	I	N	G					D	A	Y		M	O	D	E
T	E	L	?	?	?										

4. Dial station number being assigned.  
 Example: Station 104.

R	I	N	G					D	A	Y		M	O	D	E
T	E	L	1	0	4										

5. Each line position L1 to L15 should be selected to assign the desired ringing feature for the station chosen in step 3. (See Note 2).

LED ON (green) = Ring - All CPU levels  
 LED ON (red) = Delayed Ring - CPU-EB3 or higher  
 LED OFF = No Ring - All CPU levels

6. Depress ENTER key. (See Note 1).

R	I	N	G					D	A	Y		M	O	D	E
T	E	L	1	0	5										

7. Repeat step 5 until all desired Multiline Terminals are programmed.

8. Depressing F20 toggles the programming between day and night mode.

R	I	N	G			N	I	G	H	T		M	O	D	E
T	E	L	?	?	?										

9. If more stations need programming, depress F/W or B/W keys until desired station number is displayed, then go to step 5.

10. When all Multiline Terminals have been programmed for day and night mode ringing, depress the SPKR key to go back on line.



**KEY FUNCTION (OFF LINE)**

<b>SPKR - ON/OFF Line</b>
<b>TEL # - Select station to be assigned.</b>
<b>F/W (Forward) - Increment station number.</b>
<b>CLEAR -</b>
<b>ENTER - Entry to each station assigned.</b>
<b>B/W (Backward) - Decrement station number.</b>

**GUIDE TO FEATURE PROGRAMMING**

MEMORY BLOCK BEING PROGRAMMED	MEMORY BLOCK THAT MUST BE PROGRAMMED	MEMORY BLOCK THAT MAY HAVE TO BE PROGRAMMED
<b>1B</b>	1A	1D3

See Step 5 for CPU levels.

**NOTES:**

1. Depressing the ENTER key causes the assignment to advance to the next station number.
2. When programming appearances for a 6 button station, L1 ~ L5 are selected on the programming station.

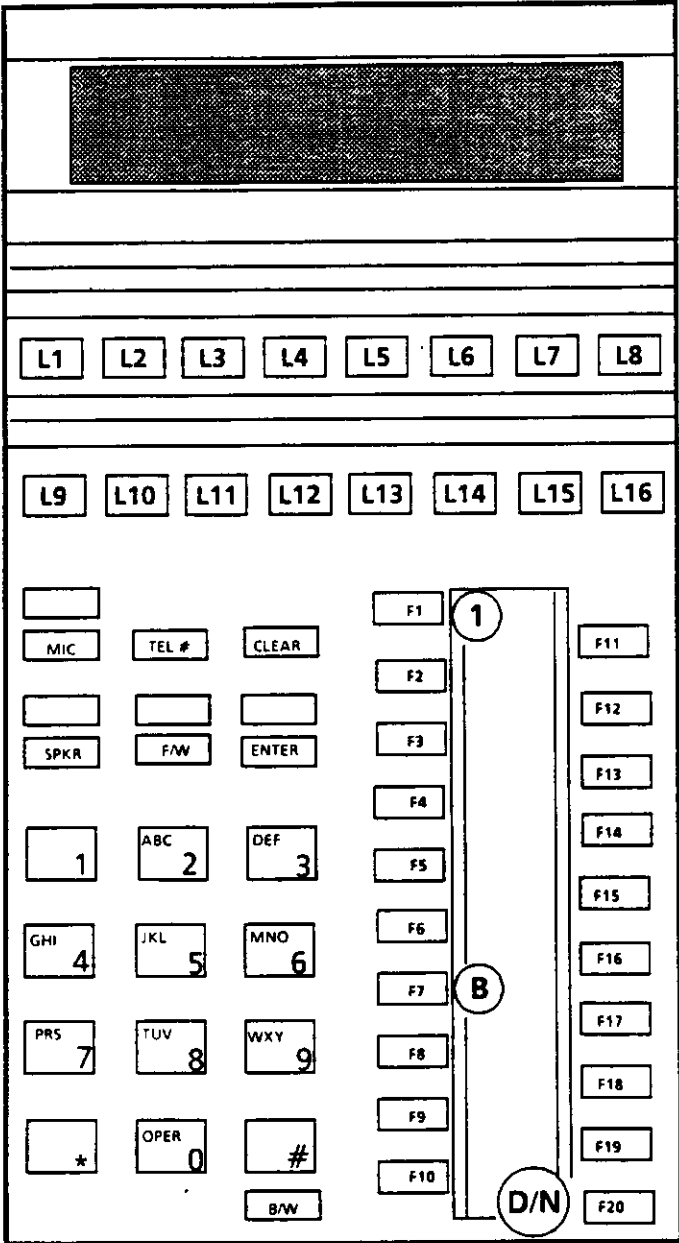

**GENERAL INFORMATION - RINGING ASSIGNMENT**

This area of memory is used to assign both day and night mode ringing features for the line appearance of each Multiline Terminal, other than the primary extension. The programming allows the flexibility of a per line per station immediate or delayed ringing option for day and night conditions.

## MEMORY BLOCK 1C1 - DSS/BLF TO ATTENDANT ASSIGNMENT

OPERATION ← AND → DISPLAY

1. Go off line. (See Note 1).

O	F	F	-	L	I	N	E		(	X	.	X	X	)
P	R	O	G	R	A	M		M	O	D	E			

2. Depress F1, then F8.

T	E	R	M	I	N	A	L		D	S	S	/	B	L	F

3. Depress F11.

D	S	S		T	O		A	T	T		A	S	G	N	.
D	S	S	?												

4. Enter device number of DSS/BLF to be assigned (1 ~ 6). Example: 1. (See Notes 2 & 4).

D	S	S		T	O		A	T	T		A	S	G	N	.
D	S	S	1		-		V	A	C	A	N	T			

5. Enter the attendant number (1 ~ 4) to be associated with the DSS/BLF.  
 Example: 3.

D	S	S		T	O		A	T	T		A	S	G	N	.
D	S	S	1		-		A	T	T	3					

6. Depress ENTER key.

D	S	S		T	O		A	T	T		A	S	G	N	.
D	S	S	2		-		V	A	C	A	N	T			

7. Repeat steps 5 and 6 for additional DSS/BLF console assignments. (See Note 4).
8. When all DSS/BLF to attendant assignments are completed, depress the SPKR key to go back on line.

**KEY FUNCTION (OFF LINE)**

<b>SPKR</b> - ON/OFF Line
<b>TEL #</b> - Selects DSS/BLF to be assigned
<b>F/W (Forward)</b> - Increment device number
<b>CLEAR</b> - Clears previous assignment
<b>ENTER</b> - Enter for each attendant assigned
<b>B/W (Backward)</b> - Decrement device number

**GUIDE TO FEATURE PROGRAMMING**

MEMORY BLOCK BEING PROGRAMMED	MEMORY BLOCK THAT MUST BE PROGRAMMED	MEMORY BLOCK THAT MAY HAVE TO BE PROGRAMMED
<b>1C1</b>		3A2, 3A4

All CPU levels.  
**NOTES:**

1. Before a DSS/BLF can be assigned to the 3rd or 4th attendant station, the station must first be assigned as an attendant.
2. Display will show **VACANT** or **ATT X** (X = 1 to 4) depending on whether an assignment was made previously.
3. A maximum of two DSS/BLFs can be assigned to one attendant.
4. Use the **B/W** and **F/W** keys to quickly locate a particular device, when required.

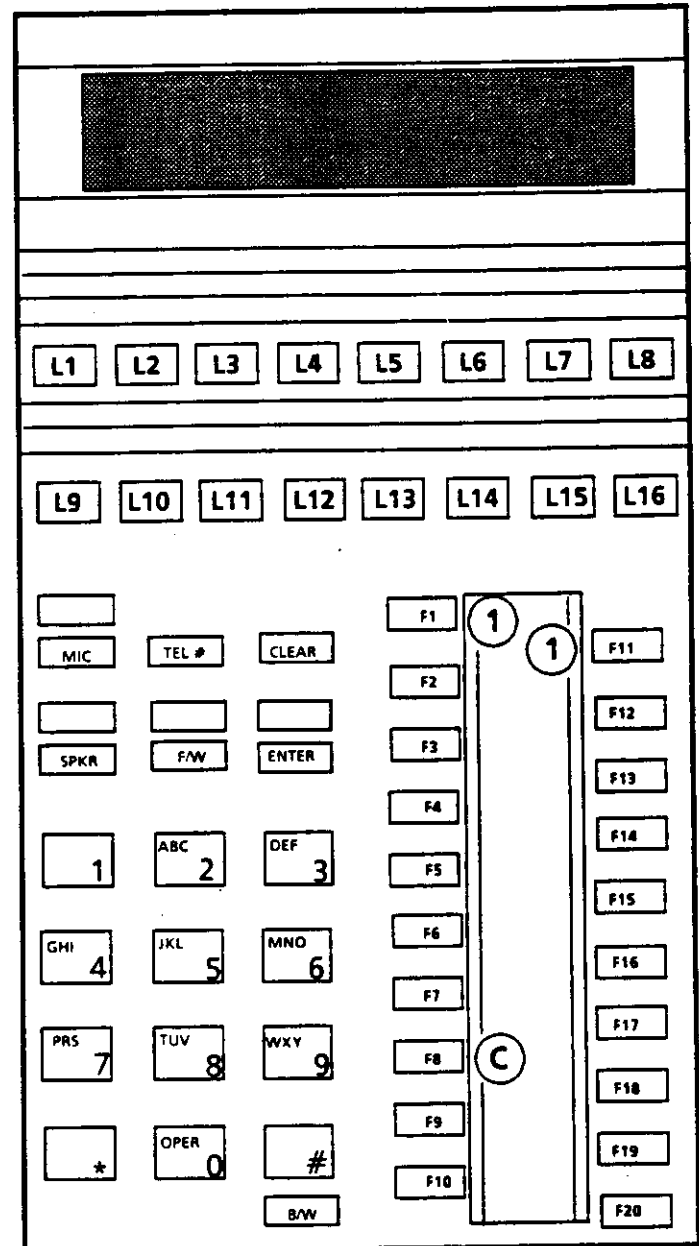

**GENERAL INFORMATION - DSS/BLF TO ATTENDANT ASSIGNMENT**

The DSS/BLF console, of which there can be a maximum of 6, are assigned to attendant positions in this memory block. This programming area is closely related to memory block 3A2 (Attendant 3rd. & 4th. Assignment) where stations are assigned as attendant positions. Memory blocks 3A2 and 3A4, when needed, must be programmed prior to programming this memory block.

## MEMORY BLOCK 1C2 - BLF TERMINAL ASSIGNMENT

OPERATION ← AND → DISPLAY

1. Go off line.

O	F	F	-	L	I	N	E		(	X	.	X	X	)
P	R	O	G	R	A	M		M	O	D	E			

2. Depress F1, then F8.

T	E	R	M	I	N	A	L		D	S	S	/	B	L	F

3. Depress F12.

	B	L	F		T	E	L		A	S	S	I	G	N
0	1		-		T	E	L	?	?	?				

4. Enter extension number to be assigned.  
 Example: 104. (See Notes 1, 2, and 3).

	B	L	F		T	E	L		A	S	S	I	G	N
0	1		-		T	E	L	1	0	4				

5. Depress ENTER key.

	B	L	F		T	E	L		A	S	S	I	G	N
0	2		-		T	E	L	?	?	?				

6. Repeat steps 4 and 5 for each of the required stations to be assigned.
7. When all required stations are assigned, depress the SPKR key to go back on line.

**KEY FUNCTION (OFF LINE)**

<b>SPKR</b> - ON/OFF Line
<b>TEL #</b> - Returns display to number 01
<b>F/W (Forward)</b> - Increment BLF number
<b>CLEAR</b> - Clears station BLF assigned
<b>ENTER</b> - Enter each assignment
<b>B/W (Backward)</b> - Decrement BLF number

**GUIDE TO FEATURE PROGRAMMING**

MEMORY BLOCK BEING PROGRAMMED	MEMORY BLOCK THAT MUST BE PROGRAMMED	MEMORY BLOCK THAT MAY HAVE TO BE PROGRAMMED
<b>1C2</b>		1E2

All CPU levels.

**NOTES:**

1. A maximum of 30 stations (10 per module) can be assigned the station BLF feature. Only the ETE-16D-( ) Multiline Terminals can be assigned.
2. Depressing the ENTER key causes the display to increment to the next station BLF assignment.
3. On each module, a maximum of 10 ETE-16D-( ) Multiline Terminals can be assigned the BLF feature, however, no more than 30 per system.

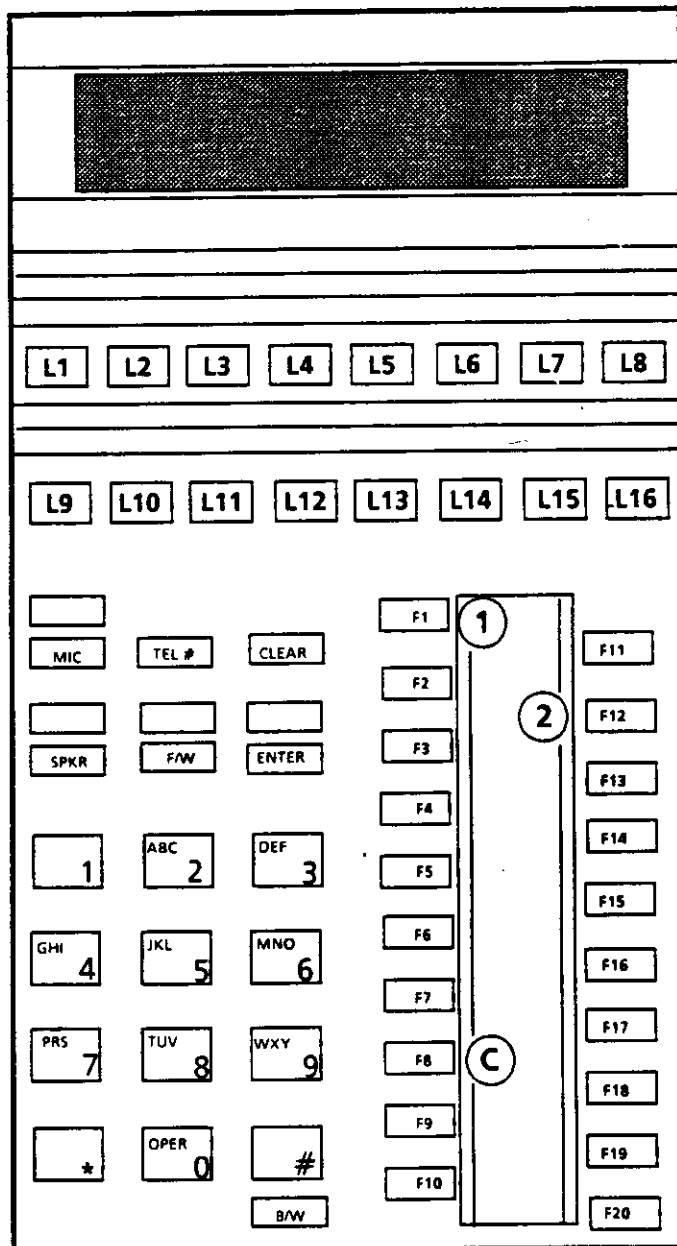

**GENERAL INFORMATION - BLF TERMINAL ASSIGNMENT**

This area of the memory block allows or denies the station BLF (Busy Lamp Field) function onto specific ETE-16D-( ) Multiline Terminals. Stations assigned indicate the station busy status via the LEDs associated with function keys programmed for DSS.

**MEMORY BLOCK 1C3 - DSS/BLF BUTTON ASSIGNMENT  
 (Feature and Station Appearance)**

OPERATION ← AND → DISPLAY

1. Go off line.

	O	F	F	-	L	I	N	E		(	X	.	X	X	)
	P	R	O	G	R	A	M		M	O	D	E			

2. Depress F1, then F8.

T	E	R	M	I	N	A	L		D	S	S	/	B	L	F

3. Depress F13.

D	S	S		D	S	S		K	E	Y					
D	E	V	I	C	E	?									

4. Enter device number (1 ~ 6) for the DSS/BLF desired. Example: DSS 1. (See Note 1).

D	S	S	1		D	S	S		K	E	Y				
R	O	W	1						V	A	C	A	N	T	

5. For feature assignment, go to step 8.

6. Dial terminal, virtual extension, or station hunting pilot number to be assigned. Example: Station 104. (VE requires CPU-EB or higher level ETU.) (Hunting pilot number requires CPU-EB3 or higher level.)

D	S	S	1		D	S	S		K	E	Y				
R	O	W	1			T	E	L	/	V	E	1	0	4	

7. Go to step 10.

8. Depress L16 to enter feature mode. (See Note 2 and General Information).

D	S	S	1		F	E	A	T	U	R	E		K	E	Y
R	O	W	6						V	A	C	A	N	T	

9. Dial feature number required.  
 Example: Number 2. (See Notes 3 and 4).

D	S	S	1		F	E	A	T	U	R	E		K	E	Y
R	O	W	6		P	A	G	E		Z	O	N	E	?	?

10. Depress ENTER key.

D	S	S	1		D	S	S		K	E	Y				
R	O	W	1			T	E	L	/	V	E	1	0	5	

11. Repeat steps 5 to 10 for all DSS buttons as required.

12. Depress SPKR key to go back on line.

**KEY FUNCTION (OFF LINE)**

<b>SPKR</b> - ON/OFF Line
<b>TEL #</b> - Enters ROW number
<b>F/W (Forward)</b> - Increments key assignment
<b>CLEAR</b> - Clears previous assignment
<b>ENTER</b> - Enters key assignment
<b>B/W (Backward)</b> - Decrements key assignment

**GUIDE TO FEATURE PROGRAMMING**

MEMORY BLOCK BEING PROGRAMMED	MEMORY BLOCK THAT MUST BE PROGRAMMED	MEMORY BLOCK THAT MAY HAVE TO BE PROGRAMMED
<b>1C3</b>	<b>1C1</b>	<b>2C10</b>
		<b>3A2, 3A4</b>

All CPU levels. (See Step 6.)

**NOTES:**

- Once the device number is entered, the program automatically moves to row 1, column 1 of the selected DSS/BLF which is shown by the LED of L1 ~ L5 of the programming station.
- Depressing L16 (line key 16) toggles the programming between feature assignment and station assignment. When in feature assignment mode, assignments are made from right to left, starting with row 6 button 5.
- |                  |                    |
|------------------|--------------------|
| <b>FEATURE #</b> | <b>FEATURE</b>     |
| 2                | Paging             |
| 3                | Message Wait       |
| 4                | Transfer           |
| 5                | Attendant Override |
| 6                | Night Transfer     |

These features are usually assigned to row 6 but can be assigned to other rows after all the buttons in row 6 are assigned.
- The following is a list of codes which can be used when assigning paging:
 

05	All internal call
06	Internal zone 1
07	Internal zone 2
08	Internal zone 3
09	All internal zones
10	External zone 1
11	External zone 2
12	External zone 3

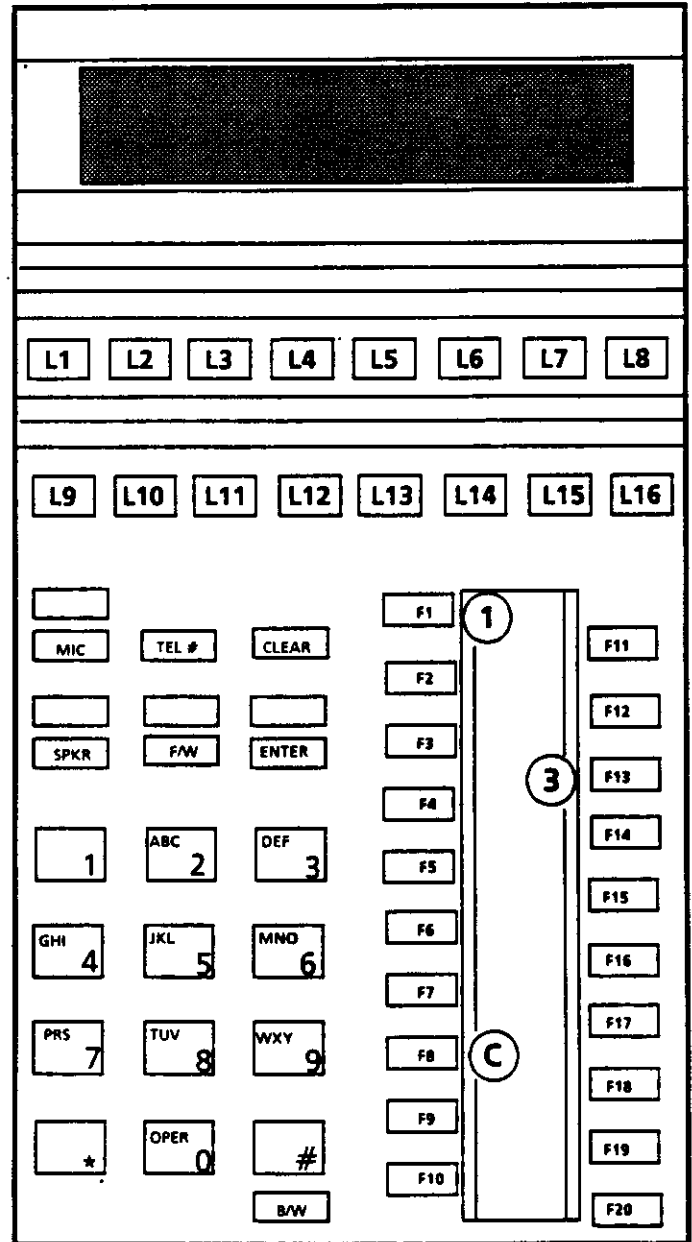

5. A station or feature should not be assigned to more than one DSS/BLF button per console.

**GENERAL INFORMATION - DSS/BLF BUTTON ASSIGNMENT**  
**(Feature and Station Appearance)**

This area of the memory block is used to designate appearances on the DSS/BLF. Each position on the DSS/BLF can have the appearance of either an extension or a feature. Extension number assignment appears on the DSS/BLF from the upper left to the lower right key, while feature assignment appears from the lower right to the upper left key.

**MEMORY BLOCK 1C4 - DSS/BLF FLEXIBLE FUNCTION KEY ASSIGNMENT**

OPERATION ← AND → DISPLAY

1. Go off line.

O	F	F	-	L	I	N	E		(	X	.	X	X	)
P	R	O	G	R	A	M		M	O	D	E			

2. Depress F1, then F8.

T	E	R	M	I	N	A	L		D	S	S	/	B	L	F

3. Depress F14.

D	S	S		F	L	X	.	F	E	A	T	U	R	E
D	E	V	I	C	E	?								

4. Enter device number (1 ~ 6) for the DSS/BLF desired. Example: DSS 1.

D	S	S	1		F	L	X	.	F	E	A	T	U	R	E
F	L	X	1		X	X	X	X	X	X	X	X	X	X	X

5. Depress L1 ~ L3 to assign each flexible Feature Access key. Example: L2.

- L1 Left key
- L2 Center key
- L3 Right key

D	S	S	1		F	L	X	.	F	E	A	T	U	R	E
F	L	X	2		X	X	X	X	X	X	X	X	X	X	X

6. Dial the feature number that corresponds to the feature being assigned.

Example: Feature number 2, Paging.  
 (See Notes 1 & 3).

D	S	S	1		F	L	X	.	F	E	A	T	U	R	E
F	L	X	2		P	A	G	E		Z	O	N	E	?	?

Example: Feature number 3, Message Wait.

D	S	S	1		F	L	X	.	F	E	A	T	U	R	E
F	L	X	2		M	S	G	.	W	A	I	T			

Example: Feature number 4, Transfer.

D	S	S	1		F	L	X	.	F	E	A	T	U	R	E
F	L	X	2		T	R	A	N	S	F	E	R			

Example: Feature number 5, Attendant Override.

D	S	S	1		F	L	X	.	F	E	A	T	U	R	E
F	L	X	2		A	T	T		O	V	R	R	I	D	E

Example: Feature number 6, Night Transfer.

D	S	S	1		F	L	X	.	F	E	A	T	U	R	E
F	L	X	2		N	I	G	H	T		M	O	D	E	

7. Depress ENTER key. (See Note 2).



**KEY FUNCTION (OFF LINE)**

<b>SPKR</b> - ON/OFF Line
<b>TEL #</b> - Allows entry of new device number
<b>F/W</b> (Forward) - Forward to next function key
<b>CLEAR</b> - Clear previous assignment
<b>ENTER</b> - Enter function key assignment
<b>B/W</b> (Backward) - Back to previous function key

**GUIDE TO FEATURE PROGRAMMING**

MEMORY BLOCK BEING PROGRAMMED	MEMORY BLOCK THAT MUST BE PROGRAMMED	MEMORY BLOCK THAT MAY HAVE TO BE PROGRAMMED
<b>1C4</b>	1C1	1C3
		3A2, 3A4

All CPU levels.

**NOTES:**

- For paging assignment, one of the following codes is entered:

CODE	FEATURE
05	Internal all call
06	Internal zone 1
07	Internal zone 2
08	Internal zone 3
09	All internal zones
10	External zone 1
11	External zone 2
12	External zone 3
13	External all zones

- Depressing the ENTER key causes the display to increment to the next function key.

FEATURE #	FEATURE
2	Paging
3	Message Wait
4	Transfer
5	Attendant Override
6	Night Transfer

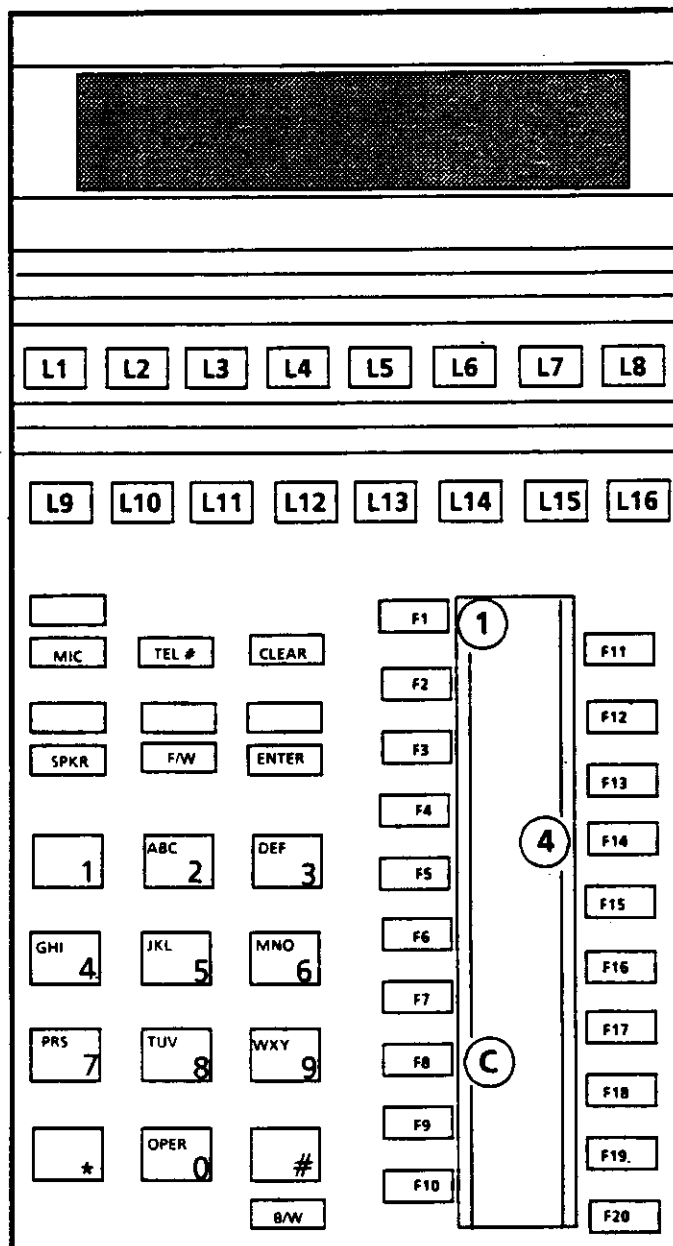

**GENERAL INFORMATION - DSS/BLF FLEXIBLE FUNCTION KEY ASSIGNMENT**

This area of the memory block is used to program the three Feature Access keys on the lower row of the DSS/BLF. These Feature Access keys can only be assigned to access features, they can not be used to access stations. A feature should not be assigned to more than one key.

## MEMORY BLOCK 1C5 - DSS TO CO ADD-ON MODULE ASSIGNMENT

OPERATION ← AND → DISPLAY

1. Go off line.
 

	O	F	F	-	L	I	N	E		(	X	.	X	X	)
	P	R	O	G	R	A	M		M	O	D	E			
  
2. Depress F1, then F8.
 

T	E	R	M	I	N	A	L		D	S	S	/	B	L	F
  
3. Depress F15.
 

C	O		A	D	M	O	D	U	L	E		A	S	G	N
D	S	S	?												
  
4. Enter the device number (1~6) of the DSS/BLF to be assigned as a CO Add-On Module.  
 Example: DSS/BLF 4. (See Notes 1 & 4).
 

C	O		A	D	M	O	D	U	L	E		A	S	G	N
D	S	S	4		C	O		A	D	M	O	D	?		
  
5. Enter the CO Add-On Module device number (1~4) to be assigned to the selected DSS/BLF.  
 Example: CO Add-On Module 2. (See Note 5).
 

C	O		A	D	M	O	D	U	L	E		A	S	G	N
D	S	S	4		C	O		A	D	M	O	D	2		
  
6. Depress ENTER key. (See Note 2).
 

C	O		A	D	M	O	D	U	L	E		A	S	G	N
D	S	S	?												
  
7. Repeat Steps 4 thru 6 for all DSS/BLFs to be assigned as CO Add-On Modules.
  
8. Depress SPKR key to go back on line.

**KEY FUNCTION (OFF LINE)**

<b>SPKR</b> - ON/OFF Line
<b>TEL #</b> - Enter new DSS/BLF device number
<b>F/W</b> -
<b>CLEAR</b> - Clears previous assignment
<b>ENTER</b> - Enter each assignment
<b>B/W</b> -

**GUIDE TO FEATURE PROGRAMMING**

MEMORY BLOCK BEING PROGRAMMED	MEMORY BLOCK THAT MUST BE PROGRAMMED	MEMORY BLOCK THAT MAY HAVE TO BE PROGRAMMED
<b>1C5</b>		1C1, 1C7, 1C8
		1C6, 1E2

CPU-EB or higher.  
**NOTES:**

1. If TEL # key is depressed (any time after step 4) the program is returned to step 3.
2. Depressing the ENTER key will return you to Step 3.
3. The flexible function keys will not operate on a DSS/BLF unit assigned as a CO Add-On module.
4. DSS to Attendant Assignment (1C1) must be vacant before assigning the EDE-30-1 as a CO Add-On module.
5. The CO Add-On module device number (1~4) will automatically associate the CO Add-On module to an attendant position (1~4) respectively.

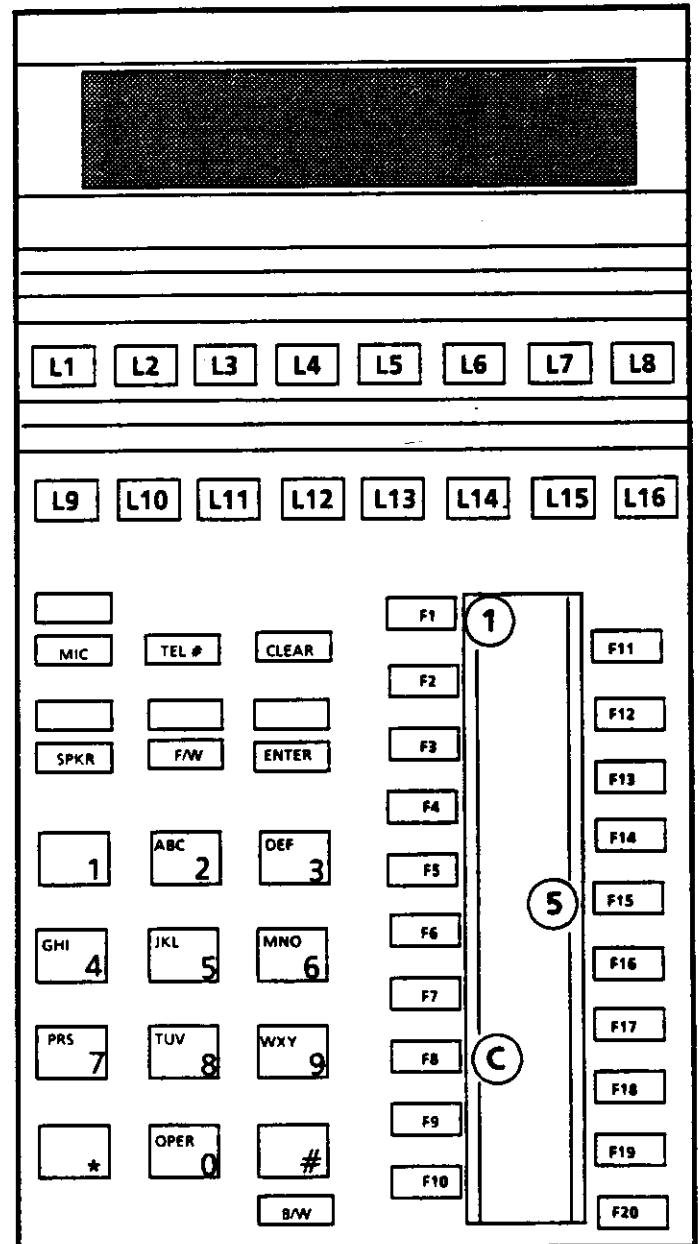

**GENERAL INFORMATION - DSS TO CO ADD-ON MODULE ASSIGNMENT**

This area of the memory block is used to assign EDE-30-1 DSS/BLF units to function as CO Add-On Modules. A maximum of four (4) DSS/BLFs can be assigned as CO Add-On Modules, this impacts the overall limit of six (6) DSS/BLF units that can be installed in a system. It is possible for a given attendant to be assigned two (2) DSS/BLF consoles and one (1) CO Add-On Module. Only an EDE-30-1 Revision B or higher can be assigned as a CO Add-On Module.

### MEMORY BLOCK 1C6 - CO ADD-ON MODULE LINE KEY ASSIGNMENT

OPERATION ← AND → DISPLAY

1. Go off line.
 

	O	F	F	-	L	I	N	E		(	X	.	X	X	)
	P	R	O	G	R	A	M		M	O	D	E			
  
2. Depress F1, then F8.
 

T	E	R	M	I	N	A	L		D	S	S	/	B	L	F
  
3. Depress F16.
 

C	O		A	D	M	O	D	U	L	E		A	S	G	N
C	O		A	D	M	O	D	?							
  
4. Enter the CO Add-On Module device number (1~4) to be assigned. Example: CO Add-On Module 3. (See Notes 1 and 2).
 

L	K		A	S	S	I	G	N		A	D	M	O	D	3
R	O	W	1							V	A	C	A	N	T
  
5. Dial the number of the CO trunk (01~40) to be assigned to the selected line button. Example: CO trunk 10; line keys L1~L5 will light in turn, corresponding to the button location within the particular row being assigned. (See Notes 3 & 4).
 

L	K		A	S	S	I	G	N		A	D	M	O	D	3
R	O	W	1							C	O	-	1	0	
  
6. Depress ENTER key.
 

L	K		A	S	S	I	G	N		A	D	M	O	D	3
R	O	W	1							V	A	C	A	N	T
  
7. Repeat Steps 5 and 6 for all line buttons on the selected device to be programmed.
  
8. Depress SPKR key to go back on line.

**KEY FUNCTION (OFF LINE)**

<b>SPKR</b> - ON/OFF Line
<b>TEL #</b> - Clears the row number
<b>F/W</b> - Forward to next line button
<b>CLEAR</b> - Clears previous button assignment
<b>ENTER</b> - Enters each line button assignment
<b>B/W</b> - Backwards to previous line button

**GUIDE TO FEATURE PROGRAMMING**

MEMORY BLOCK BEING PROGRAMMED	MEMORY BLOCK THAT MUST BE PROGRAMMED	MEMORY BLOCK THAT MAY HAVE TO BE PROGRAMMED
<b>1C6</b>	1C5	1A, 1C1, 1C7,
		1C5, 1C8, 1E2

CPU-EB or higher.

**NOTES:**

1. If TEL # key is depressed once (any time after step 4); the display's second line will change to show:

R	O	W	?																
---	---	---	---	--	--	--	--	--	--	--	--	--	--	--	--	--	--	--	--

This allows selection of individual rows.

2. If TEL # key is depressed twice (any time after step 4) the program is returned to step 3.
3. If a CO trunk is already assigned, depressing the CLEAR and ENTER keys assigns this line key as VACANT.
4. A CO trunk which already appears on a line key on the associated attendants' ETE-16D(-) terminal, cannot also be programmed on the CO line key console.

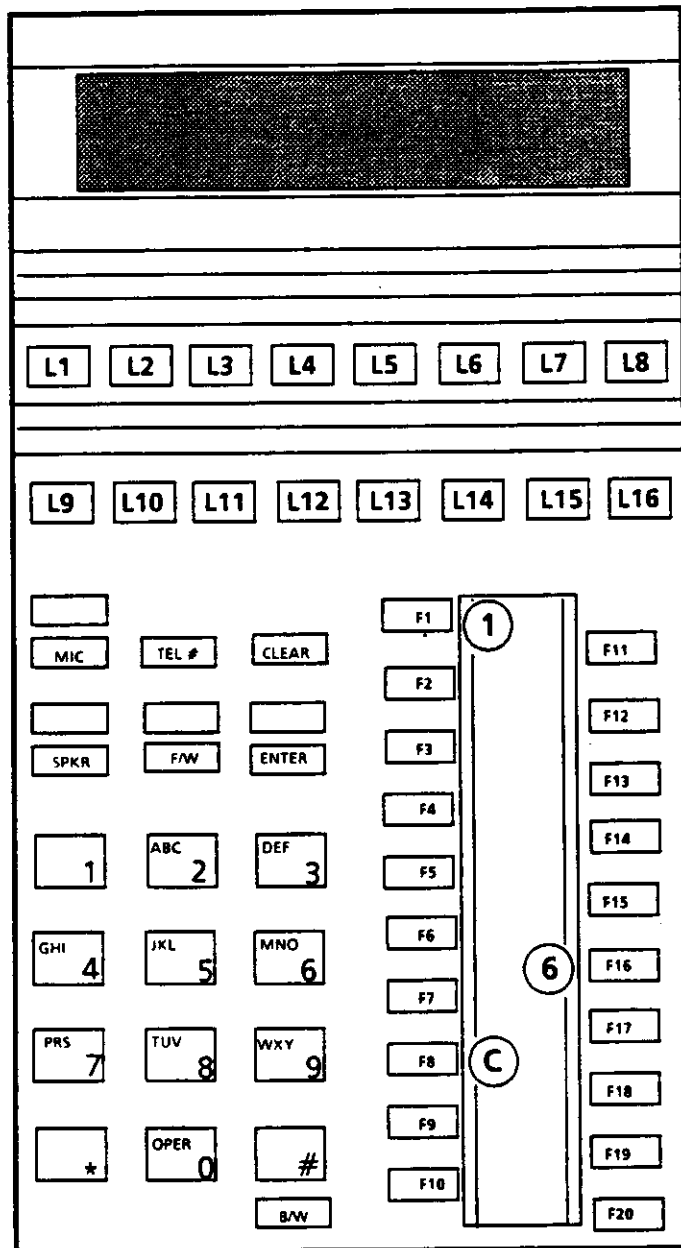

**GENERAL INFORMATION - CO ADD-ON MODULE**  
LINE KEY ASSIGNMENT

This area of the memory block is used to assign CO trunk appearances to the line buttons of DSS/BLF units assigned as CO Add-On Modules.

## MEMORY BLOCK 1C7 - CO ADD-ON MODULE DAY RING ASSIGNMENT

OPERATION ← AND → DISPLAY

1. Go off line.
 

	O	F	F	-	L	I	N	E		(	X	.	X	X	)		
	P	R	O	G	R	A	M		M	O	D	E					
  
2. Depress F1, then F8.
 

T	E	R	M	I	N	A	L		D	S	S	/	B	L	F		
  
3. Depress F17.
 

A	D	M	O	D		D	A	Y		R	I	N	G				
C	O		A	D	M	O	D	?									
  
4. Enter the device number (1~4) of the CO Add-On Module to be programmed.  
 Example: CO Add-On Module 2. (See Note 1).
 

D	A	Y		R	I	N	G			A	D	M	O	D		2	
R	O	W		1													
  
5. Depress line keys L1~L5 to assign the desired ringing pattern as shown below:
 

D	A	Y		R	I	N	G			A	D	M	O	D		2	
R	O	W		1													

Green LED ON: Ring - CPU-EB or higher.  
 Red LED ON: Delayed Ring - CPU-EB3 or higher.  
 LED OFF: No Ring - CPU-EB or higher.
  
6. Depress ENTER key. (See Note 2).
 

D	A	Y		R	I	N	G			A	D	M	O	D		2	
R	O	W		2													
  
7. Repeat Steps 5 and 6 for all line keys to be programmed on the selected device.
  
8. Depress SPKR key to go back on line.

**KEY FUNCTION (OFF LINE)**

<b>SPKR</b> - ON/OFF Line
<b>TEL #</b> - Clear row number
<b>F/W (Forward)</b> - Increments row number
<b>CLEAR</b> -
<b>ENTER</b> - Enter each assignment
<b>B/W (Backward)</b> - Decrements row number

**GUIDE TO FEATURE PROGRAMMING**

MEMORY BLOCK BEING PROGRAMMED	MEMORY BLOCK THAT MUST BE PROGRAMMED	MEMORY BLOCK THAT MAY HAVE TO BE PROGRAMMED
<b>1C7</b>	1C5, 1C6	1C8, 1E2

CPU-EB or higher. (See Step 5.)  
**NOTES:**

1. After a device number has been entered, line keys L1~L5 will display the previous ring assignment of the selected row.
2. Depressing the ENTER key will cause the display to increment to the next row of the selected device.

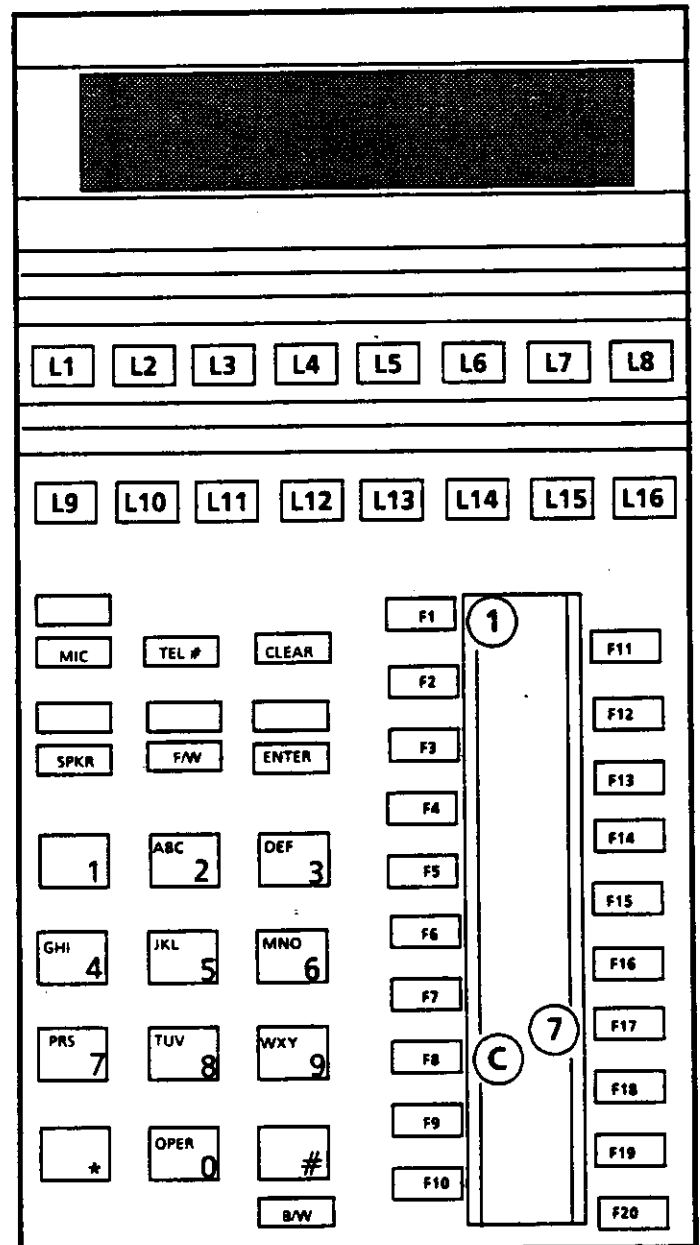

**GENERAL INFORMATION - CO ADD-ON MODULE DAY RING ASSIGNMENT**

This area of the memory block is used to assign Day Mode Ringing to CO trunk appearances on the CO Add-On Modules.

**MEMORY BLOCK 1C8 - CO ADD-ON MODULE NIGHT RING ASSIGNMENT**

OPERATION ← AND → DISPLAY

1. Go off line.

	O	F	F	-	L	I	N	E		(	X	.	X	X	)
	P	R	O	G	R	A	M		M	O	D	E			

2. Depress F1, then F8.

T	E	R	M	I	N	A	L		D	S	S	/	B	L	F

3. Depress F18.

A	D	M	O	D		N	I	G	H	T		R	I	N	G
C	O		A	D	M	O	D	?							

4. Enter the device number (1~4) of the CO Add-On Module to be programmed. Example: CO Add-On Module 3. (See Note 1)

N	I	G	H	T		R	N	G		A	D	M	O	D	3
R	O	W	1												

5. Depress line keys L1~L5 to assign the desired ringing pattern:

N	I	G	H	T		R	N	G		A	D	M	O	D	3
R	O	W	1												

- Green LED ON: Ring - CPU-EB or higher.
- Red LED ON: Delayed Ring- CPU-EB3 or higher.
- LED OFF: No Ring - CPU-EB or higher.

6. Depress ENTER key. (See Note 2).

N	I	G	H	T		R	N	G		A	D	M	O	D	3
R	O	W	2												

7. Repeat Steps 5 and 6 for all line keys to be assigned on the selected device.

8. Depress SPKR key to go back on line.



**KEY FUNCTION (OFF LINE)**

<b>SPKR</b> - ON/OFF Line
<b>TEL #</b> - Clears row number
<b>F/W (Forward)</b> - Increments row number
<b>CLEAR</b> -
<b>ENTER</b> - Enter each assignment
<b>B/W (Backward)</b> - Decrements row number

**GUIDE TO FEATURE PROGRAMMING**

MEMORY BLOCK BEING PROGRAMMED	MEMORY BLOCK THAT MUST BE PROGRAMMED	MEMORY BLOCK THAT MAY HAVE TO BE PROGRAMMED
<b>1C8</b>	1C5, 1C6	1C7, 1E2

CPU-EB or higher. (See Step 5.)

**NOTES:**

1. After a device number has been entered, line keys L1~L5 will display the previous ring assignment of the selected row.
2. Depressing the ENTER key will cause the display to increment to the next row of the selected device.

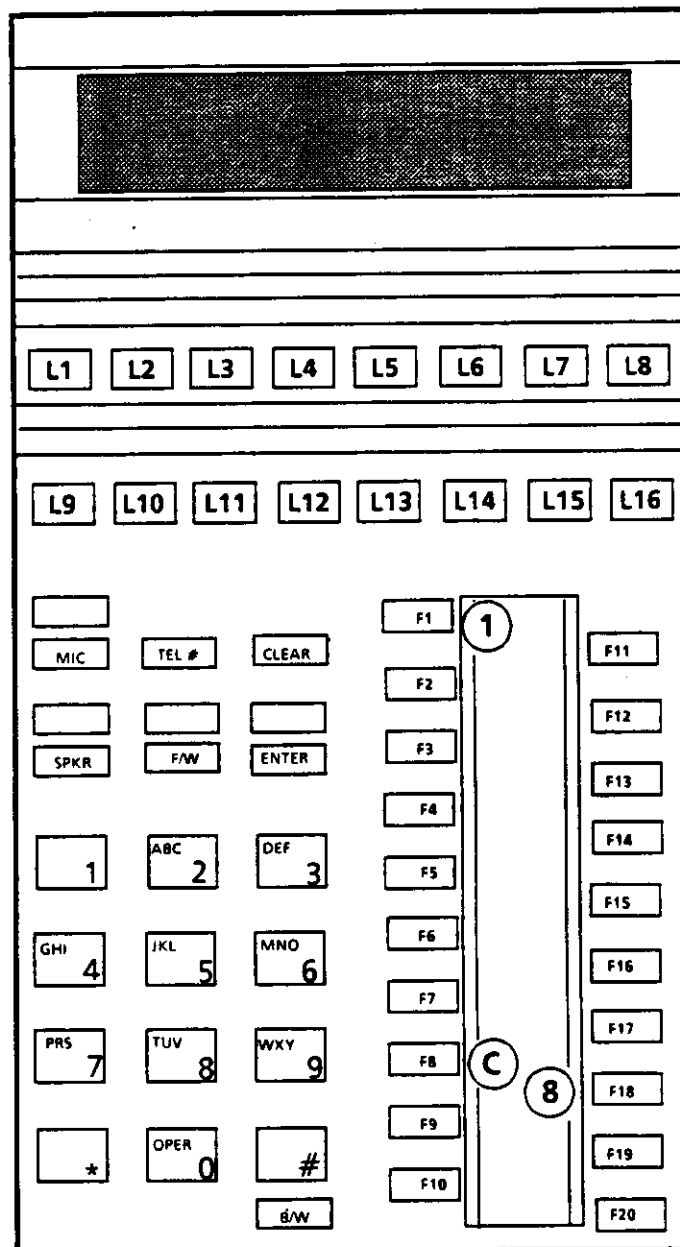

**GENERAL INFORMATION - CO ADD-ON MODULE NIGHT RING ASSIGNMENT**

This area of the memory block is used to assign Night Ringing to CO trunk appearances on the CO Add-On Modules.

### MEMORY BLOCK 1D1 - PRIME / RINGING LINE ASSIGNMENT

OPERATION   ←   AND   →   DISPLAY

1. Go off line.
 

O	F	F	-	L	I	N	E		(	X	.	X	X	)
P	R	O	G	R	A	M		M	O	D	E			
  
2. Depress F1, then F9.
 

T	E	R	M	I	N	A	L		F	E	A	T	U	R	E
  
3. Depress F11.
 

P	R	M	.	/	R	N	G	.	L	.	P	R	E	F	
T	E	L	?	?	?										
  
4. Dial station number to be assigned.  
 Example: Station 104. (See Note 1).
 

P	R	M	.	/	R	N	G	.	L	.	P	R	E	F	
T	E	L	1	0	4				X	X	X	X	X	X	X
  
5. Dial a one digit code to select the appropriate function (See Note 2). Prime line: dial 1 and depress the line key (LK1~16) to be assigned. (See Note 3).
 

P	R	M	.	/	R	N	G	.	L	.	P	R	E	F	
T	E	L	1	0	4				P	R	I	M	E	L	.
  
- or Ringing line: Dial 2.
 

P	R	M	.	/	R	N	G	.	L	.	P	R	E	F		
T	E	L	1	0	4				R	I	N	G	I	N	G	L
  
- or Prime/Ring line: Dial 3. Depress desired line key. (See Notes 3 & 5).
 

P	R	M	.	/	R	N	G	.	L	.	P	R	E	F			
T	E	L	1	0	4				P	R	M	.	/	R	N	G	.
  
- or For SLT CO Prime Line: Dial 4.  
 Enter desired Trunk Number (See Notes 6 & 7).  
 (CPU-EB2 or higher.)
 

P	R	M	.	/	R	N	G	.	L	.	P	R	E	F			
T	E	L	1	0	4				-		T	R	U	N	K	?	?
  
- or For no assignment: Dial 0.
 

P	R	M	.	/	R	N	G	.	L	.	P	R	E	F		
T	E	L	1	0	4				N	O	T		S	E	T	
  
6. Depress ENTER key. (See Note 4).
 

P	R	M	.	/	R	N	G	.	L	.	P	R	E	F		
T	E	L	1	0	5				X	X	X	X	X	X	X	X
  
7. Repeat steps 5 and 6 for all subsequent stations, or go back to step 3 to program a specific station.
 

P	R	M	.	/	R	N	G	.	L	.	P	R	E	F		
T	E	L	?	?	?											
  
8. When programming is complete, depress SPKR key to go back on line.

**KEY FUNCTION (OFF LINE)**

SPKR - ON/OFF Line
TEL # - Selects station to be programmed
F/W (Forward) - Increments station number
CLEAR -
ENTER - Enters assignment to each station
B/W (Backward) - Decrements the station number

**GUIDE TO FEATURE PROGRAMMING**

MEMORY BLOCK BEING PROGRAMMED	MEMORY BLOCK THAT MUST BE PROGRAMMED	MEMORY BLOCK THAT MAY HAVE TO BE PROGRAMMED
1D1	1A	1B, 2E1

All CPU levels. (See Step 5.)  
**NOTES:**

- During step 4, the display shows the current assignment of the station.
- |            |                   |
|------------|-------------------|
| DIGIT CODE | FEATURE           |
| 1          | Prime Line        |
| 2          | Ringng Line       |
| 3          | Prime/Ringng      |
| 4          | SLT CO Prime Line |
| 0          | Not Set           |
- For ETE-6-( ) and ETE-6D-( ) Multiline Terminal, LK 1 ~ 6 should be used. For SLTs LK 1 should be used.
- Depressing the ENTER key causes the display to increment to the next station number.
- Ringng line preference takes priority over prime line when both are assigned.
- SLT CO Prime Line can be assigned to stations supported by SLI or VMI ports only.
- An access code must be programmed for CO release if internal dial tone is required (Access code item 93).

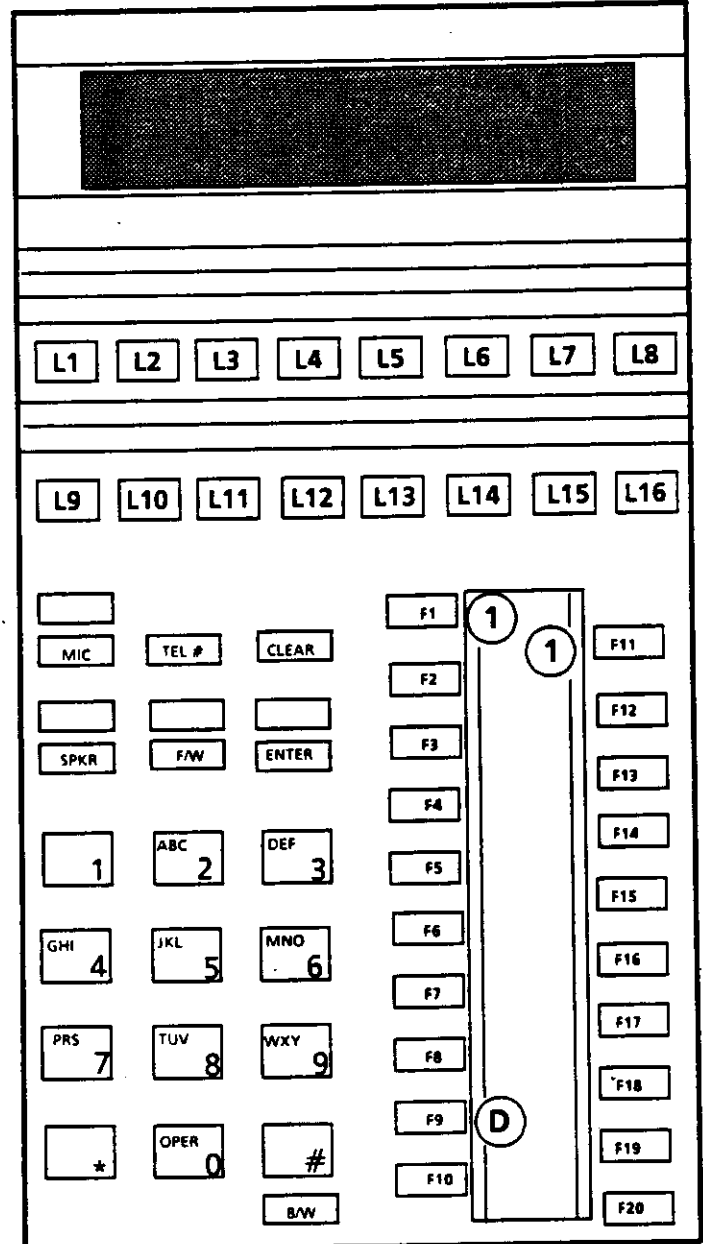

**GENERAL INFORMATION - PRIME / RINGING LINE ASSIGNMENT**

This area of the memory block is used to assign prime line and/or ringng line preference to all Multiline Terminals and to assign CO Prime Line or Extension Prime Line to SLTs. When *prime line* or *prime/ringng line* feature is chosen, a line key must be selected (depressed) for each station.

**MEMORY BLOCK 1D2 - DATA SERVICE ASSIGNMENT**

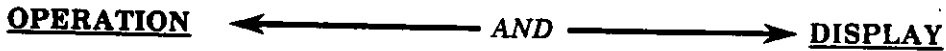

1. Go off line.

O	F	F	-	L	I	N	E		(	X	.	X	X	)
P	R	O	G	R	A	M		M	O	D	E			

2. Depress F1, then F9.

T	E	R	M	I	N	A	L		F	E	A	T	U	R	E

3. Depress F12.

D	A	T	A		S	E	R	V	I	C	E			
T	E	L	?	?	?									

4. Dial station number to be assigned.  
 Example: Station 120. (See Note 1).

D	A	T	A		T	E	R	M	.		1	2	0		
D	E	P	R	E	S	S		L	I	N	E		K	E	Y

5. Depress line keys L1~L6 to select desired parameters. (See Note 2).

6. Depress ENTER key. (See Note 3).

D	A	T	A		T	E	R	M	.		1	2	1		
D	E	P	R	E	S	S		L	I	N	E		K	E	Y

7. Repeat Steps 5 and 6 for all subsequent stations, or go to Step 3 to program a specific station.

8. Depress SPKR key to go back on line.

**KEY FUNCTION (OFF LINE)**

<b>SPKR - ON/OFF Line</b>
<b>TEL # - Select station to be programmed</b>
<b>F/W (Forward) - Increments station number</b>
<b>CLEAR -</b>
<b>ENTER - Enter assignment to each station</b>
<b>B/W (Backward) - Decrements station number</b>

**GUIDE TO FEATURE PROGRAMMING**

MEMORY BLOCK BEING PROGRAMMED	MEMORY BLOCK THAT MUST BE PROGRAMMED	MEMORY BLOCK THAT MAY HAVE TO BE PROGRAMMED
<b>1D2</b>	<b>4B4</b>	<b>1A</b>

CPU-EB or higher.

**NOTES:**

- After step 4, line keys L1~L6 will show the parameters previously selected.
  - Line keys L1~L6 correspond to the following:
    - L1 Automatic Answer    LED ON: YES  
                              \*OFF: NO
    - L2 Automatic Release    LED ON: YES  
                              \*OFF: NO
    - L3 DTR Signal Validity\* (Terminal)    LED ON: VALID  
  \*OFF: INVALID
    - DSR Signal Validity \*LED ON: VALID  
  OFF: INVALID
    - L4 Incoming Internal Data Call during CO conversation    LED ON: ALLOW  
  \*OFF: PROHIBIT
    - L5 Depressing the DR key after receiving an internal data call, during CO conversation    LED ON: Rejects the internal call and activates modem pool.  
  \*LED OFF: Answers the internal data call.
    - L6 LCD Indication for data calls    \*LED ON: Provided  
  OFF: Not Provided
- \* = Default
- Depressing the ENTER key causes the display to increment to the next station.

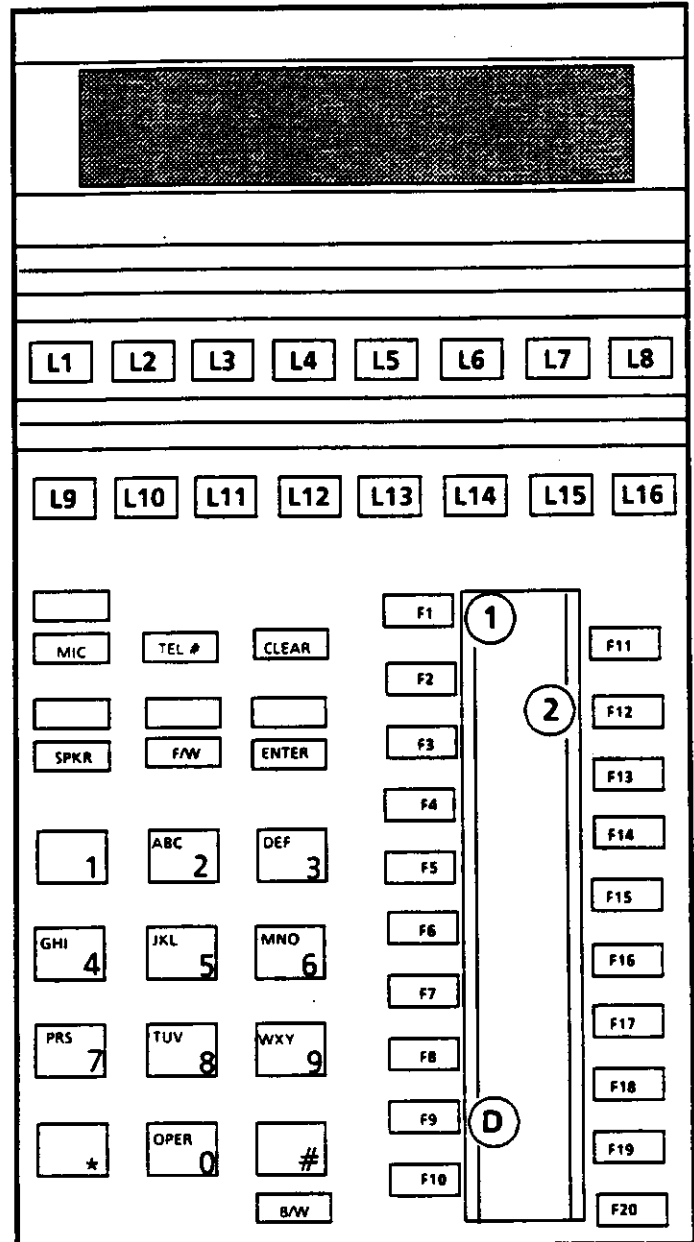

• When using a remote printer for internal data communications, it is recommended that the DTR signal (for the station supporting the printer) be programmed as INVALID. Otherwise, the data path stays connected until the printer is turned off and the system sees a change in DTR status. When connected to a modem, the DTR signal is supplied by the DSR signal from the modem validity.

**GENERAL INFORMATION - DATA SERVICE ASSIGNMENT**

This area of the memory block is used to assign the various operational parameters to stations equipped and programmed to support data communications.

## MEMORY BLOCK 1D3 - USER PROGRAM ASSIGNMENT

OPERATION ← AND → DISPLAY

1. Go off line.

	O	F	F	-	L	I	N	E		(	X	.	X	X	)
	P	R	O	G	R	A	M		M	O	D	E			

2. Depress F1, then F9.

T	E	R	M	I	N	A	L		F	E	A	T	U	R	E

3. Depress F13.

U	S	E	R		P	R	O	G	R	A	M				
T	E	L	?	?	?										

4. Dial station number to be assigned.  
 Example: Station 104. (See Note 1).

	U	S	E	R		P	.		T	E	L	1	0	4	
				L	I	N	E		K	E	Y	1	-	3	

5. If no change in status is desired, proceed to step 7.

6. Depress L1 ~ L3 to select appropriate feature capability. (See Note 1).

7. Depress ENTER key. (See Note 2). Repeat steps 5 ~ 7 for all subsequent stations, or go to step 3 to program a specific station.

	U	S	E	R		P	.		T	E	L	1	0	5	
S	E	T		L	I	N	E		K	E	Y	1	-	3	

8. Depress SPKR key to go back on line.

**KEY FUNCTION (OFF LINE)**

<b>SPKR</b> - ON/OFF Line
<b>TEL #</b> - Select station to be programmed
<b>F/W</b> (Forward) - Increment station number
<b>CLEAR</b> -
<b>ENTER</b> - Enter assignment to each station
<b>B/W</b> (Backward) - Decrement the station number

**GUIDE TO FEATURE PROGRAMMING**

MEMORY BLOCK BEING PROGRAMMED	MEMORY BLOCK THAT MUST BE PROGRAMMED	MEMORY BLOCK THAT MAY HAVE TO BE PROGRAMMED
<b>1D3</b>		<b>1B</b>

All CPU levels.  
**NOTES:**

- L1~ L3 selects an optional feature for the selected station.
 

L1 Off Hook Ringing	ON: Ring	OFF: No Ring
L2 Internal Voice/Ring	ON: Ring	OFF: Voice
L3 Ring Tone	ON: Tone #2	OFF: Tone #1
- Depressing the ENTER key causes the display to increment to the next station.

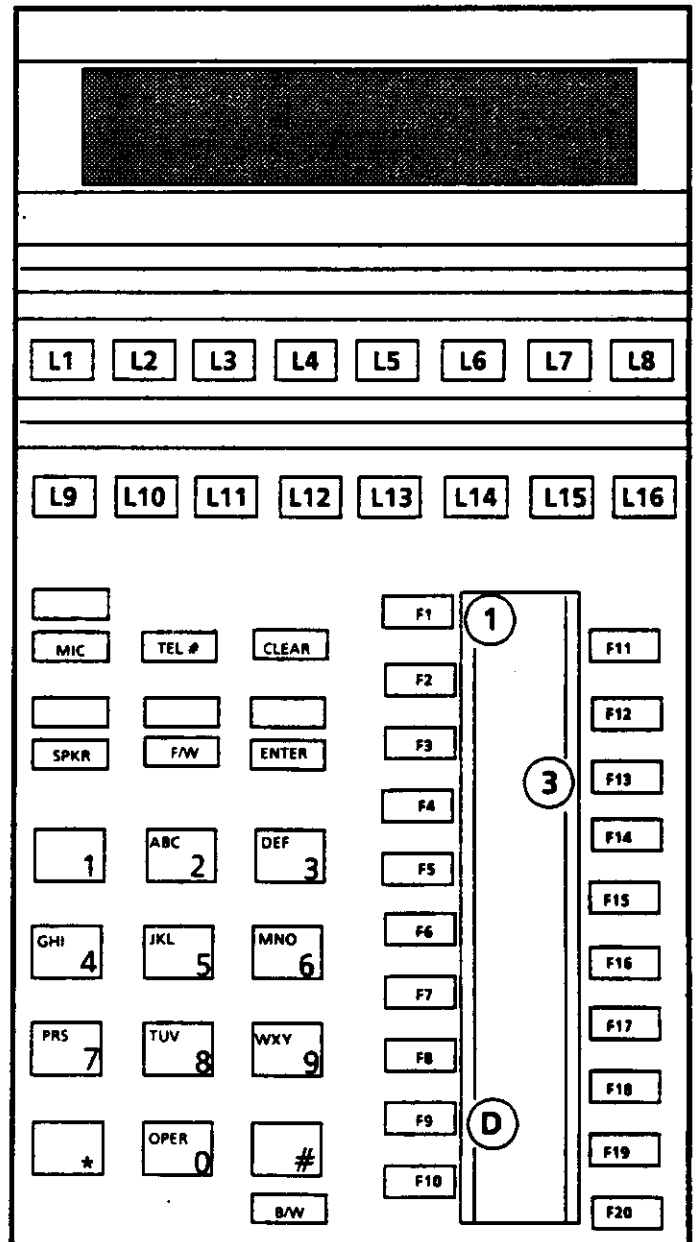

**GENERAL INFORMATION - USER PROGRAM ASSIGNMENT**

This area of the memory block is used for the attendant or programming terminal to individually change certain default optional features that are assigned individually from each Multiline Terminal. These user controlled features include off hook ringing, voice and tone signaling on intercom, and selection of ring tone.

**MEMORY BLOCK 1D4 - TRUNK GROUP INCOMING RESTRICTION**

OPERATION ← AND → DISPLAY

1. Go off line.

	O	F	-	L	I	N	E		(	X	.	X	X	)
	P	R	O	G	R	A	M		M	O	D	E		

2. Depress F1, then F9.

T	E	R	M	I	N	A	L		F	E	A	T	U	R	E

3. Depress F14.

T	R	K	.	G		I	N	C	O	M	.	R	E	S	T
T	E	L	?	?	?										

4. Dial station number to be assigned.  
 Example: Station 104. (See Note 1).

T	R	K	.	G		I	N	C	O	M	.	R	E	S	T
T	E	L	1	0	4										

5. L1 to L8 represent trunk groups 1 to 8 respectively. If no change in status is required, proceed to step 7.

6. Depress L1 to L8 to allow or deny access to the trunk groups for incoming calls.  
 LED ON = Restricted, LED OFF = Unrestricted.

7. Depress ENTER key. Repeat steps 5 ~ 7 for all subsequent Multiline Terminals (See Note 2), or go to step 3 to restrict a specific terminal.

T	R	K	.	G		I	N	C	O	M	.	R	E	S	T
T	E	L	1	0	5										

8. Depress SPKR key to go back on line.



**KEY FUNCTION (OFF LINE)**

<b>SPKR</b> - ON/OFF Line
<b>TEL #</b> - Selects station to be programmed
<b>F/W</b> (Forward) - Increments station number
<b>CLEAR</b> -
<b>ENTER</b> - Enters assignment to each station
<b>B/W</b> (Backward) - Decrements the station

number

**GUIDE TO FEATURE PROGRAMMING**

MEMORY BLOCK BEING PROGRAMMED	MEMORY BLOCK THAT MUST BE PROGRAMMED	MEMORY BLOCK THAT MAY HAVE TO BE PROGRAMMED
<b>1D4</b>	2C1	2C2

All CPU levels.

**NOTES:**

1. During step 4, L1 to L8 correspond to trunk groups 1 to 8 respectively and will show any previous assignment.

LED on = restricted  
 LED off = unrestricted

2. Depressing the ENTER key causes the display to increment to the next station number.

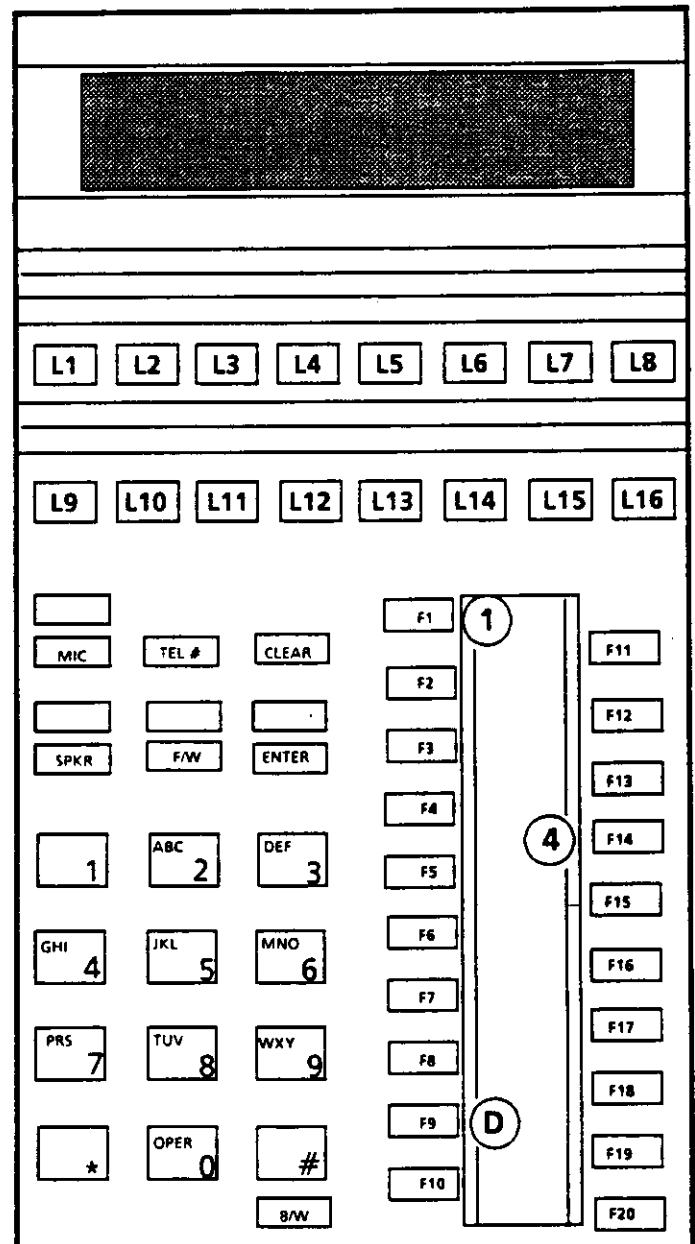

**GENERAL INFORMATION - TRUNK GROUP INCOMING RESTRICTION**

This memory block is used to assign incoming restrictions to Multiline Terminals on a trunk group basis.

## MEMORY BLOCK 1D5 - TRUNK GROUP OUTGOING RESTRICTION

OPERATION ← AND → DISPLAY

1. Go off line.

	O	F	F	-	L	I	N	E		(	X	.	X	X	)
	P	R	O	G	R	A	M		M	O	D	E			

2. Depress F1, then F9.

T	E	R	M	I	N	A	L		F	E	A	T	U	R	E

3. Depress F15.

T	R	K	.	G		O	U	T	G	O	.	R	E	S	T
T	E	L	?	?	?										

4. Dial station number to be assigned.  
 Example: Station 104. (See Note 1).

T	R	K	.	G		O	U	T	G	O	.	R	E	S	T
T	E	L	1	0	4										

5. L1 to L8 represent trunk groups 1 to 8 respectively. If no change in status is required, proceed to step 7.

6. Depress L1 to L8 to allow or deny access to the trunk groups for outgoing calls.  
 LED ON = Restricted, LED OFF = Unrestricted.

7. Depress ENTER key. Repeat steps 5 ~ 7 for all subsequent Multiline Terminals or go to step 3 to restrict a specific terminal. (See Note 2).

T	R	K	.	G		O	U	T	G	O	.	R	E	S	T
T	E	L	1	0	5										

8. Depress SPKR key to go back on line.

**KEY FUNCTION (OFF LINE)**

<b>SPKR</b> - ON/OFF Line
<b>TEL #</b> - Select station to be programmed
<b>F/W</b> (Forward) - Increment station number
<b>CLEAR</b> -
<b>ENTER</b> - Enter assignment to each station
<b>B/W</b> (Backward) - Decrement the station number

**GUIDE TO FEATURE PROGRAMMING**

MEMORY BLOCK BEING PROGRAMMED	MEMORY BLOCK THAT MUST BE PROGRAMMED	MEMORY BLOCK THAT MAY HAVE TO BE PROGRAMMED
<b>1D5</b>	2C1	2C2, 2C3

All CPU levels.

**NOTES:**

1. During step 4, L1 to L8 correspond to trunk groups 1 to 8 respectively and will show any previous assignment.

LED on = restricted  
 LED off = unrestricted

2. Depressing the ENTER key causes the display to increment to the next station number.

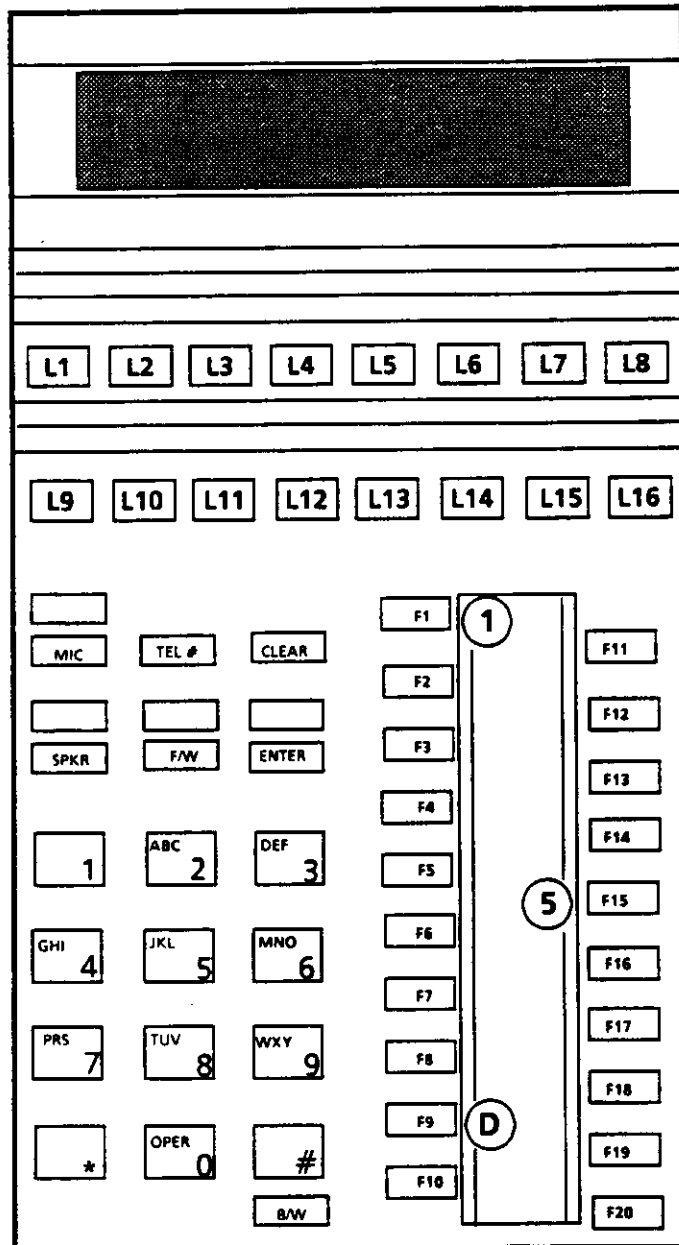

**GENERAL INFORMATION - TRUNK GROUP OUTGOING RESTRICTION**

This area of the memory block is used to restrict stations from making outgoing calls on a trunk group basis. The outgoing restriction applies to both direct and dial access to trunk groups.

**MEMORY BLOCK 1D6 - CODE RESTRICTION TABLE ACCESS**

OPERATION ← AND → DISPLAY

1. Go off line.

	O	F	F	-	L	I	N	E		(	X	.	X	X	)
	P	R	O	G	R	A	M		M	O	D	E			

2. Depress F1, then F9.

T	E	R	M	I	N	A	L		F	E	A	T	U	R	E

3. Depress F16.

C	O	D	E		R	E	S	T	R	I	C	T	I	O	N
T	E	L	?	?	?										

4. Dial station number to be assigned.  
 Example: Station 104. (See Note 1).

C	O	D	E		R	E	S	T	.		#	1	0	4	
T	A	B	L	E		0	1	-	1	6					

5. Depress L1 ~ L16 to assign system code tables 1 to 16.

6. Depress ENTER key. (See Note 2).

C	O	D	E		R	E	S	T	.		#	1	0	4	
T	A	B	L	E		1	7	-	3	2					

7. Depress L1 ~ L 16 to assign system code tables 17 ~ 32.

8. Depress ENTER key. (See Note 2).

C	O	D	E		R	E	S	T	.		#	1	0	5	
T	A	B	L	E		0	1	-	1	6					

9. Repeat steps 5 ~ 8 for all subsequent stations or go to step 3 to restrict a specific station.

10. Depress SPKR key to go back on line.

**KEY FUNCTION (OFF LINE)**

<b>SPKR - ON/OFF Line</b>
<b>TEL # - Select station to be programmed</b>
<b>F/W (Forward) - Increment table/station number</b>
<b>CLEAR -</b>
<b>ENTER - Enter assignment to each station</b>
<b>B/W (Backward) - Decrement table/station number</b>

**GUIDE TO FEATURE PROGRAMMING**

MEMORY BLOCK BEING PROGRAMMED	MEMORY BLOCK THAT MUST BE PROGRAMMED	MEMORY BLOCK THAT MAY HAVE TO BE PROGRAMMED
<b>1D6</b>	1D7	3E1, 3E2, 3E3
	3E5, 3E6, 3E9	3E4, 3E7, 3E8,
		3E10

All CPU levels.  
**NOTES:**

1. During step 4, L1 to L16 will display which of the restriction tables, 1 to 16, have been assigned to the station chosen. L1 to L16 correspond to tables 1 to 16 or 17 to 32.
2. When display shows table 1 to 16, depressing the ENTER key causes the display to increment to tables 17 to 32. If the ENTER key is depressed once again, the display now increments to the next station number.
3. In Memory Block 1D7 (Class of Service Assignment); line key L5 must be ON (Operator Restriction Assigned).

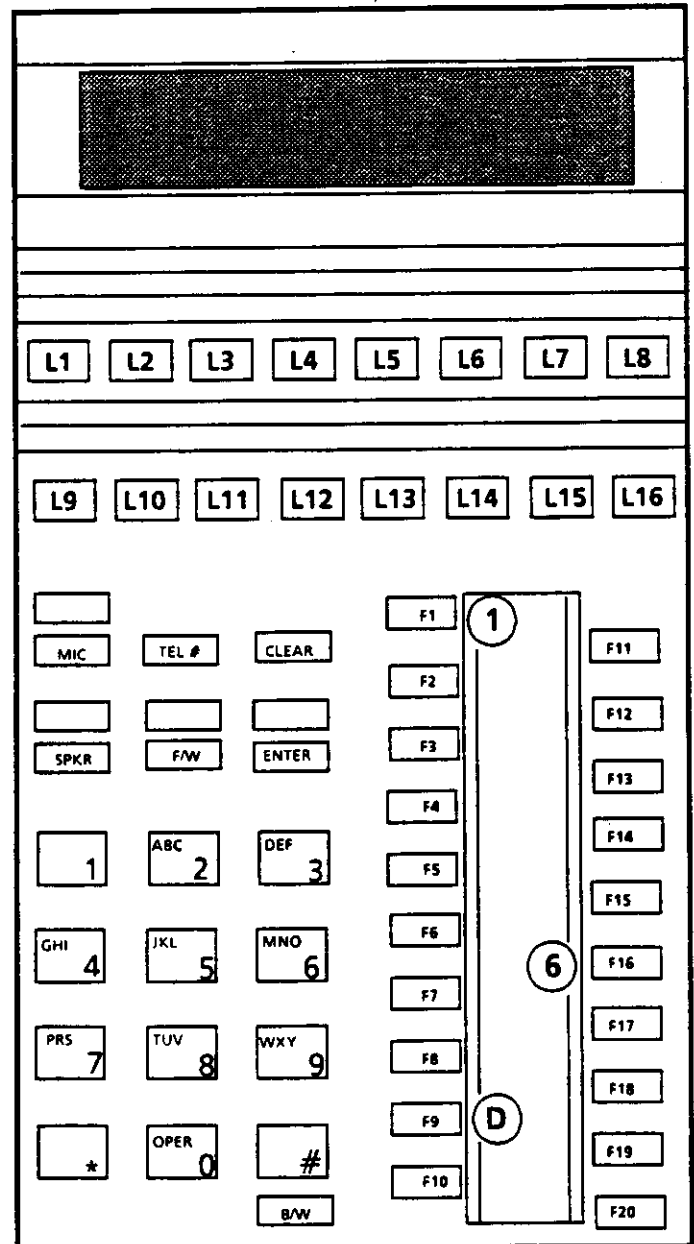

**GENERAL INFORMATION - CODE RESTRICTION TABLE ACCESS**

This area of the memory block is used to assign up to 32 system code restriction tables to each station as needed. Refer to section 360 of this manual for a discussion of the system code tables.

**MEMORY BLOCK 1D7 - CLASS OF SERVICE ASSIGNMENT**

OPERATION ← AND → DISPLAY

1. Go off line.

O	F	F	-	L	I	N	E		(	X	.	X	X	)
P	R	O	G	R	A	M		M	O	D	E			

2. Depress F1, then F9.

T	E	R	M	I	N	A	L		F	E	A	T	U	R	E

3. Depress F17.

C	L	A	S	S		O	F		S	E	R	V	I	C	E
T	E	L	?	?	?										

4. Enter the station number to be programmed.  
 Example: Station 104. (See Note 1).

C	L	S	.	O	F		S	V	C	.	#	1	0	4	
D	E	P	R	E	S	S		L	I	N	E		K	E	Y

5. Depress appropriate line keys to allow or disallow station features as required (See Note 2).

6. Depress ENTER key. (See Note 3).

C	L	S	.	O	F		S	V	C	.	#	1	0	5	
D	E	P	R	E	S	S		L	I	N	E		K	E	Y

7. Repeat steps 5 and 6 for all subsequent stations or go to step 3 to assign a specific station.

8. Depress the SPKR key to go back on line.

**KEY FUNCTION (OFF LINE)**

<b>SPKR - ON/OFF Line</b>
<b>TEL # - Selects station to be programmed</b>
<b>F/W (Forward) - Increments station number</b>
<b>CLEAR -</b>
<b>ENTER - Enters assignment to each station</b>
<b>B/W (Backward) - Decrements the station number</b>

**GUIDE TO FEATURE PROGRAMMING**

MEMORY BLOCK BEING PROGRAMMED	MEMORY BLOCK THAT MUST BE PROGRAMMED	MEMORY BLOCK THAT MAY HAVE TO BE PROGRAMMED
<b>1D7</b>		

All CPU levels. (See Note 2).

**NOTES:**

1. After the station number is entered, the line key LED's will show any previous assignment to the station.
2. Each of the following programming keys is selected to allow or disallow these terminal features.

LED ON = Enabled    LED OFF = Disabled

- L1 = Camp-on Originate (Allow)
- L2 = Camp-on Receive (Allow)
- L3 = Call Forward, All or Busy/No Answer (Allow)
- L5 = Operator Restriction (Deny)
- L6 = Data Line Security (Deny)
- L11 = Station Lockout (Deny)
- L12 = Page Access , Originate (Allow)
- L13 = LCR Priority (Deny)
- L14 = Trunk to Trunk Transfer (Deny) (CPU-EB2 or higher)
- L15 = Account Code Forced/Verified Entry (Deny) (CPU-EB3 or higher)

**NOTE:** Defaults are shown between parenthesis.

3. Depressing the ENTER key causes the display to increment to the next station number.

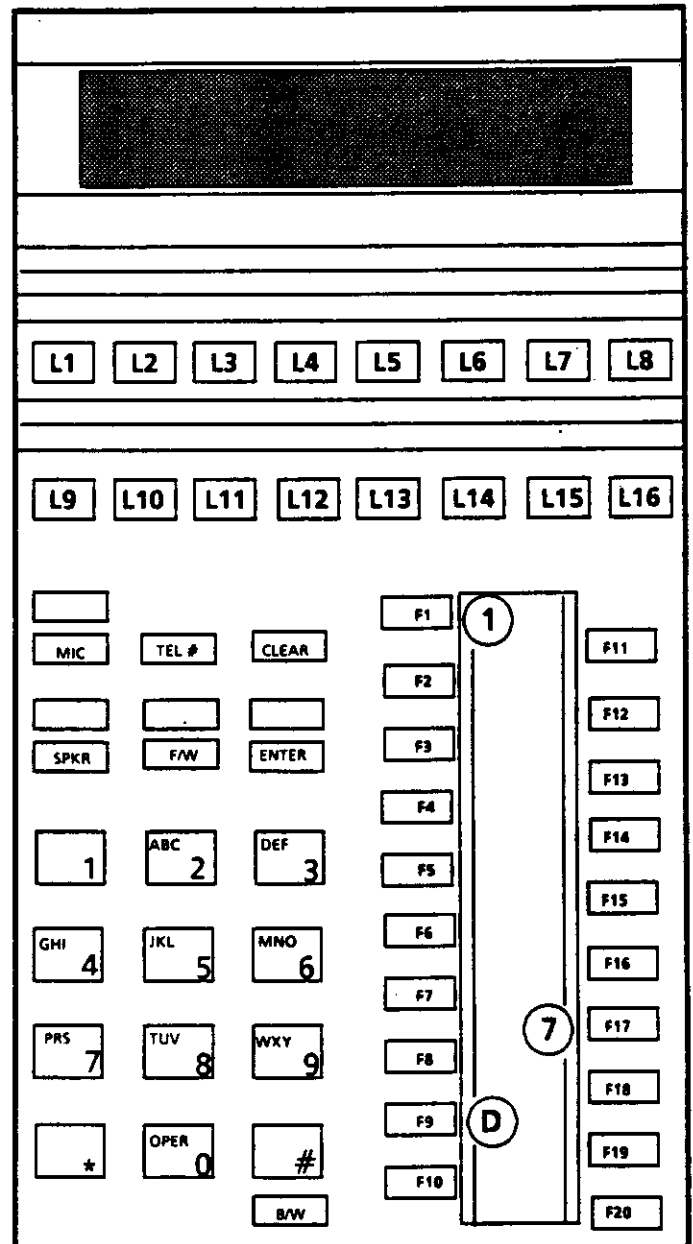

**GENERAL INFORMATION - CLASS OF SERVICE ASSIGNMENT**

This area of the memory block is used to assign a particular class of service to each station. Each class of service allows or disallows the station user from accessing specific station features.

**MEMORY BLOCK 1D8 - TERMINAL TO ATTENDANT ASSIGNMENT**



1. Go off line.
 

	O	F	-	L	I	N	E		(	X	.	X	X	)
	P	R	O	G	R	A	M		M	O	D	E		
  
2. Depress F1, then F9.
 

T	E	R	M	I	N	A	L		F	E	A	T	U	R	E
  
3. Depress F18.
 

T	E	R	M		-		A	T	T		A	S	G	N	.
T	E	L	?	?	?										
  
4. Enter the station number to be assigned.  
 Example: Station 104. (See Note 1).
 

T	E	R	M		-		A	T	T		A	S	G	N	.
T	E	L	1	0	4		-	-		A	T	T	X		
  
5. Enter attendant number (1 ~ 4) to be assigned to the station chosen in step 4.  
 Example = Attendant 2.
 

T	E	R	M		-		A	T	T		A	S	G	N	.
T	E	L	1	0	4		-	-		A	T	T	2		
  
6. Depress ENTER key. (See Note 2).
 

T	E	R	M		-		A	T	T		A	S	G	N	.
T	E	L	1	0	5		-	-		A	T	T	X		
  
7. Repeat steps 5 and 6 for all subsequent stations or go to step 3 to assign a specific station.
  
8. Depress SPKR key to go back on line.



**KEY FUNCTION (OFF LINE)**

<b>SPKR</b> - ON/OFF Line
<b>TEL #</b> - Select station to be programmed
<b>F/W</b> (Forward) - Increment station number
<b>CLEAR</b> -
<b>ENTER</b> - Enter assignment to each station
<b>B/W</b> (Backward) - Decrement the station number

**GUIDE TO FEATURE PROGRAMMING**

MEMORY BLOCK BEING PROGRAMMED	MEMORY BLOCK THAT MUST BE PROGRAMMED	MEMORY BLOCK THAT MAY HAVE TO BE PROGRAMMED
<b>1D8</b>		<b>3A2, 3A4</b>

All CPU levels.

**NOTES:**

1. After station number is entered, the display will show previous attendant assigned to the station.
2. Depressing the ENTER key causes the display to increment to the next station number.

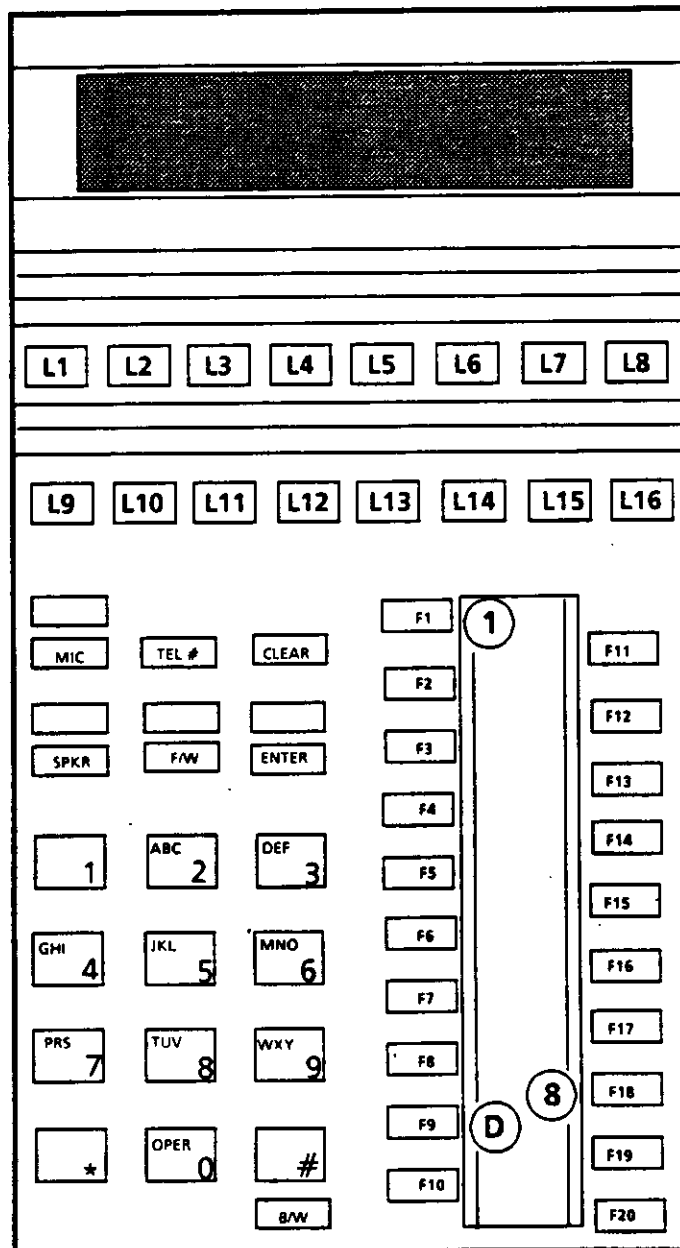

**GENERAL INFORMATION - TERMINAL TO ATTENDANT ASSIGNMENT**

This area of the memory block is used to assign each station to one of the four possible associated attendants. If the system requires more than 2 attendants and/or more than one tenant, memory blocks 3A2 and/or 3A4 must be programmed **BEFORE** this memory block.

## MEMORY BLOCK 1D9 - TERMINAL TO PAGING ZONE ASSIGNMENT

OPERATION ← AND → DISPLAY

1. Go off line.
 

	O	F	F	-	L	I	N	E		(	X	.	X	X	)
	P	R	O	G	R	A	M		M	O	D	E			
  
2. Depress F1, then F9.
 

T	E	R	M	I	N	A	L		F	E	A	T	U	R	E
  
3. Depress F19.
 

T	E	R	M	-	Z	O	N	E		P	A	G	I	N	G
T	E	L	?	?	?										
  
4. Enter the station number to be assigned.  
 Example: Station 104. (See Note 1).
 

T	E	R	M	-	Z	O	N	E		P	A	G	I	N	G
T	E	L	1	0	4		-	Z	O	N	E	X			
  
5. Enter zone number (0~3) to be assigned to the station chosen in step 5. Example: Zone 2. (See Note 2).
 

T	E	R	M	-	Z	O	N	E		P	A	G	I	N	G
T	E	L	1	0	4		-	Z	O	N	E	2			
  
6. Depress ENTER key. (See Note 3).
 

T	E	R	M	-	Z	O	N	E		P	A	G	I	N	G
T	E	L	1	0	5		-	Z	O	N	E	X			
  
7. Repeat steps 5 and 6 for all required stations or go to step 3 to assign a paging zone to a specific station.
  
8. Depress SPKR key to go back on line.

**KEY FUNCTION (OFF LINE)**

SPKR - ON/OFF Line
TEL # - Select station to be programmed
F/W (Forward) - Increment station number
CLEAR -
ENTER - Enter assignment to each station
B/W (Backward) - Decrement the station number

**GUIDE TO FEATURE PROGRAMMING**

MEMORY BLOCK BEING PROGRAMMED	MEMORY BLOCK THAT MUST BE PROGRAMMED	MEMORY BLOCK THAT MAY HAVE TO BE PROGRAMMED
<b>1D9</b>		

All CPU levels.

**NOTES:**

1. After station number is entered, the display will show previous zone number assigned to the station.
2. Zone 0 is a no zone assignment.
3. Depressing the ENTER key causes the display to increment to the next station number.

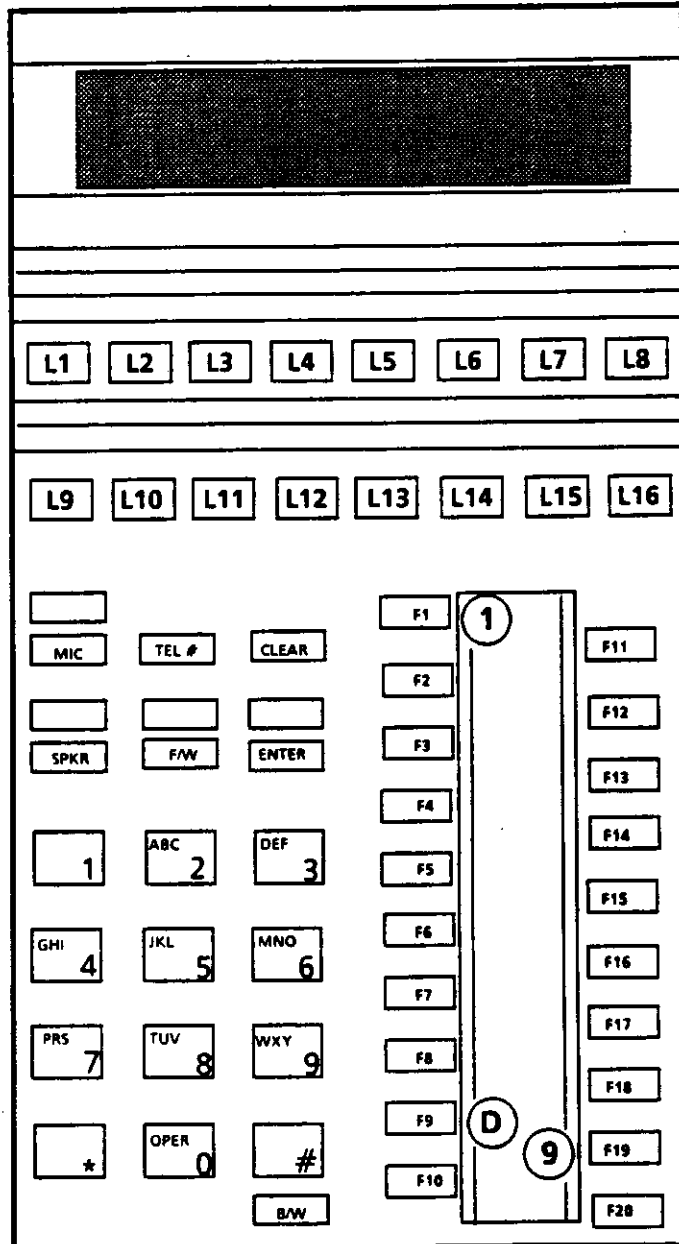

**GENERAL INFORMATION - TERMINAL TO PAGING ZONE ASSIGNMENT**

This area of the memory block is used to assign each Multiline Terminal to one of the three internal page zones in the system. If necessary, a Multiline Terminal can be placed in a no zone assignment.

**MEMORY BLOCK 1D10 - CALL PICK-UP GROUP ASSIGNMENT**

OPERATION ← AND → DISPLAY

1. Go off line.

	O	F	F	-	L	I	N	E		(	X	.	X	X	)
	P	R	O	G	R	A	M		M	O	D	E			

2. Depress F1, then F9.

T	E	R	M	I	N	A	L		F	E	A	T	U	R	E

3. Depress F20.

C	A	L	L		P	I	C	K		U	P	.	G		
T	E	L	?	?	?										

4. Enter the station number to be assigned.  
 Example: Station 104. (See Note 1).

C	A	L	L		P	I	C	K		U	P	.	G		
T	E	L	1	0	4		-	P	I	C	.	G	?		

5. Enter group number to be assigned to the station  
 chosen in step 4. Example = Pick-up group 1.  
 (See Note 2).

C	A	L	L		P	I	C	K		U	P	.	G		
T	E	L	1	0	4		-	P	I	C	.	G	1		

6. Depress ENTER key. (See Note 4).

C	A	L	L		P	I	C	K		U	P	.	G		
T	E	L	1	0	5		-	P	I	C	.	G	?		

7. Repeat steps 5 and 6 for all required stations or go to step 3 to assign a call pick-up to a specific station.

8. Depress SPKR key to go back on line.

**KEY FUNCTION (OFF LINE)**

<b>SPKR</b> - ON/OFF Line
<b>TEL #</b> - Select station to be programmed
<b>F/W (Forward)</b> - Increment station number
<b>CLEAR</b> - Clear pickup group assignment
<b>ENTER</b> - Enter assignment to each station
<b>B/W (Backward)</b> - Decrement the station number

**GUIDE TO FEATURE PROGRAMMING**

MEMORY BLOCK BEING PROGRAMMED	MEMORY BLOCK THAT MUST BE PROGRAMMED	MEMORY BLOCK THAT MAY HAVE TO BE PROGRAMMED
<b>1D10</b>		

All CPU levels.

**NOTES:**

1. After station number is entered, the display will show either ? or the previous pickup group number assigned to the station.
2. A station can only be assigned to one of 8 possible pickup groups in the system.
3. To enter a no group assignment depress the CLEAR key and then the ENTER key.
4. Depressing the ENTER key causes the display to increment to the next station number.

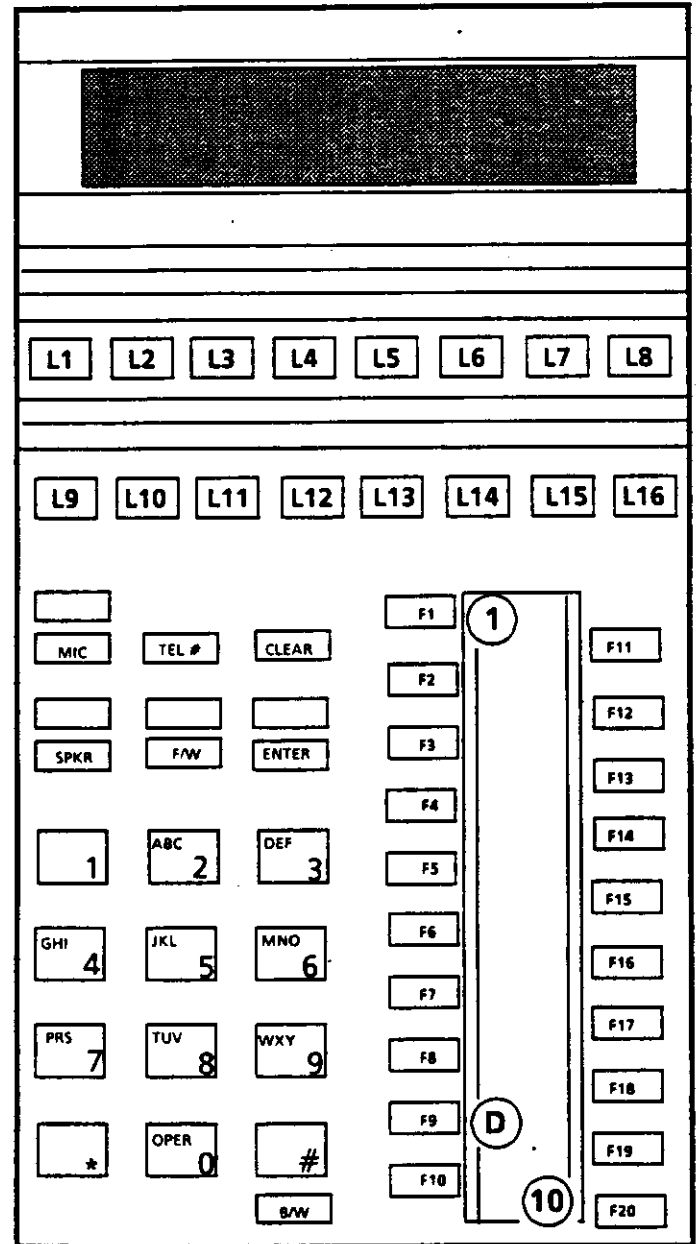

**GENERAL INFORMATION - CALL PICKUP GROUP ASSIGNMENT**

This area of the memory block is used to assign stations to call pickup groups. There are a total of 8 groups that stations can be assigned to. A station can only be assigned to one group.

**MEMORY BLOCK 1E1 - TERMINAL EXCHANGE**

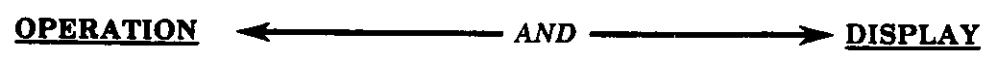

1. Go off line. 

	O	F	F	-	L	I	N	E		(	X	.	X	X	)
	P	R	O	G	R	A	M		M	O	D	E			

2. Depress F1, then F10. 

T	E	R	M	I	N	A	L		A	S	S	I	G	N	

3. Depress F11. 

T	E	R	M	.		E	X	C	H	A	N	G	E		
T	E	L	?	?	?	-	-	*	*	*					

4. Dial the extension number of one of the stations to be exchanged. Example: 104. 

T	E	R	M	.		E	X	C	H	A	N	G	E		
T	E	L	1	0	4	-	-	?	?	?					

5. Dial the extension number of the second station to be exchanged. Example = 120. (See Note 1). 

T	E	R	M	.		E	X	C	H	A	N	G	E		
T	E	L	1	0	4	-	-	1	2	0					

6. Depress ENTER key. 

T	E	R	M	.		E	X	C	H	A	N	G	E		
T	E	L	?	?	?	-	-	*	*	*					

7. Repeat steps 4 to 6 for any other pair of stations that may require terminal exchange.

8. Depress SPKR key to go back on line.

**KEY FUNCTION (OFF LINE)**

<b>SPKR</b> - ON/OFF Line
<b>TEL #</b> - Select station to be programmed
<b>F/W</b> (Forward) -
<b>CLEAR</b> -
<b>ENTER</b> - Enter assignment to each pair of stations
<b>B/W</b> (Backward) -

**GUIDE TO FEATURE PROGRAMMING**

MEMORY BLOCK BEING PROGRAMMED	MEMORY BLOCK THAT MUST BE PROGRAMMED	MEMORY BLOCK THAT MAY HAVE TO BE PROGRAMMED
<b>1E1</b>		1C2, 2A1, 3A2

All CPU levels.

**NOTES:**

- This exchange will only operate correctly if the following conditions are met:
  - Both stations are the same type.
  - Neither ETE-16D(-) is an associated attendant. (See 3A2)
  - Neither ETE-16D(-) is a programming position. (See 2A1)
  - Both stations are idle.
  - Neither ETE-16D(-) is assigned BLF feature. (See 1C2).

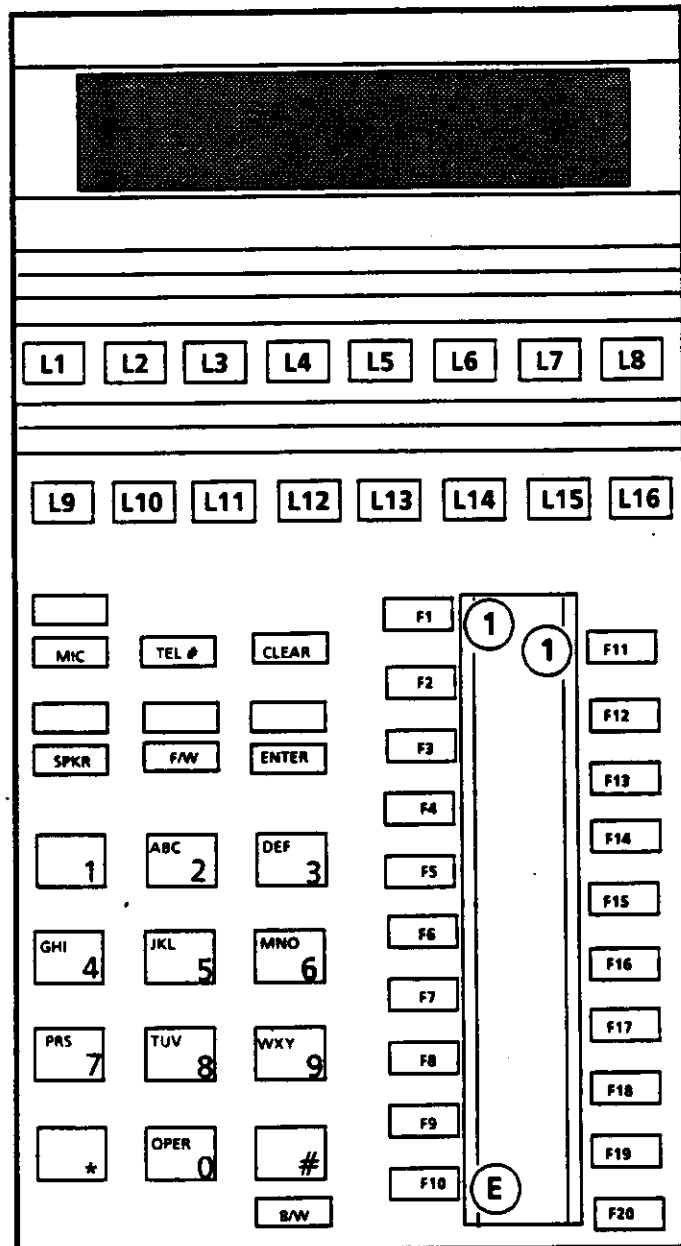

**GENERAL INFORMATION - TERMINAL EXCHANGE**

This area of the memory block is used to exchange station numbers and feature programming between two stations of the same type.

## MEMORY BLOCK 1E2 - TERMINAL ADD-PORT (EQUIPMENT TYPE ASSIGNMENT)

OPERATION ← AND → DISPLAY

1. Go off line.

		O	F	F	-	L	I	N	E		(	X	.	X	X	)
		P	R	O	G	R	A	M		M	O	D	E			

2. Depress F1, then F10.

T	E	R	M	I	N	A	L		A	S	S	I	G	N		

3. Depress F12.

T	E	R	M	.	A	D	D		P	O	R	T				
M	O	D	?		S	L	O	T	*		C	H	*			

4. Enter module number (1 to 4), to select a specific CCU. Example: 1. (Selects the ESE-32B-1 CCU).

T	E	R	M	.	A	D	D		P	O	R	T				
M	O	D	1		S	L	O	T	?		C	H	*			

5. Enter slot number (1 to 8), to select a specific interface slot. Example: 3. (Selects the 3rd. card slot from the right side of the selected CCU).

T	E	R	M	.	A	D	D		P	O	R	T				
M	O	D	1		S	L	O	T	3		C	H	?			

6. Enter channel number (1 to 4), to select a specific circuit of an interface card.  
 Example = 4 (Selects the 4th. circuit on the selected card slot, in step 5).

T	E	R	M	.	A	D	D		P	O	R	T				
M	O	D	1		S	L	O	T	3		C	H	4			

7. Depress the line key associated with the device type to be assigned to the port. (See Note 1).

T	E	R	M	.	A	D	D		P	O	R	T				
M	O	D	1		S	L	O	T	3		C	H	4			

8. Depress ENTER key. (See Notes 3, 4, & 5).

T	E	R	M	.	A	D	D		P	O	R	T				
M	O	D	1		S	L	O	T	4		C	H	1			

9. Depress TEL # key and repeat steps 4 to 8 for all additional port assignments. (See Note 2).

T	E	R	M	.	A	D	D		P	O	R	T				
M	O	D	?		S	L	O	T	*		C	H	*			

10. Depress the SPKR key to go back on line.



**KEY FUNCTION (OFF LINE)**

<b>SPKR - ON/OFF Line</b>
<b>TEL # - Selects port to be assigned</b>
<b>F/W (Forward) - Increments channel number</b>
<b>CLEAR -</b>
<b>ENTER - Enters each port assignment</b>
<b>B/W (Backward) - Decrements channel number</b>

**GUIDE TO FEATURE PROGRAMMING**

MEMORY BLOCK BEING PROGRAMMED	MEMORY BLOCK THAT MUST BE PROGRAMMED	MEMORY BLOCK THAT MAY HAVE TO BE PROGRAMMED
<b>1E2</b>		1A, 1B, 1C1
		1C2, 1D*, 2A1,
		3A2, 4C1, 4E9

All CPU levels. (See Note 1.)

**NOTES:** \* All the memory blocks of Terminal Feature Block 1D.

1. The following is a list showing the relationship of device type to line key assignments:

- L1 - ETE-16D-( )
- L2 - ETE-6D-( )
- L3 - ETE-6-( )
- L4 - ETE-16-2 (CPU-EB3 or higher)
- L5 - ETE-16K-1
- L6 - EDE-30-1
- L9 - RAA-E Unit (CPU-EB or higher)
- L16 - Indicates Vacant or Unassigned

LED ON = Assigned

2. Single line instruments are not assigned in this memory block. They can be assigned in memory block 4C1 or when the system is initialized (first or second).

3. Station assignments cannot be changed when:

- Station is busy
- ETE-16D-( ) is an attendant station (3A2)
- Station is a programming telephone (2A1)
- ETE-16D-( ) is assigned the BLF feature. (1C2)
- Station is assigned as a tandem port.
- The previous type device is still connected.

4. Terminal add port cannot be completed when the port is assigned as a DSS/BLF, therefore, the DSS/BLF assignment must be removed (1C1) before 1E2 can be completed.

5. Depressing the ENTER key causes the display to increment to the next channel number.

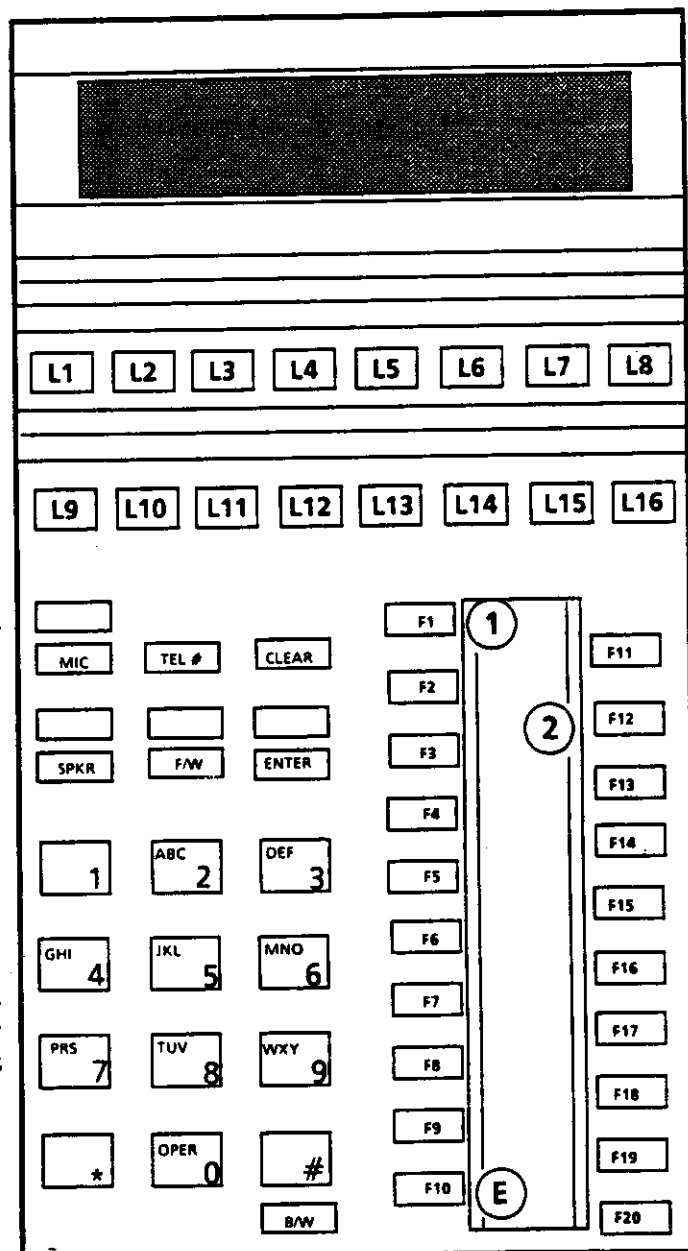

**GENERAL INFORMATION - TERMINAL ADD PORT EQUIPMENT TYPE ASSIGNMENT**

This area of the memory block is used to assign specific terminal equipment to unused ports in systems that have been previously programmed and to add new terminal equipment when expanding the system. This area of the memory block is also used to change the type of device assigned to a specific port.

## MEMORY BLOCK 1E3 - TERMINAL BUSY ASSIGNMENT

OPERATION ← AND → DISPLAY

1. Go off line.
 

O	F	F	-	L	I	N	E		(	X	.	X	X	)
P	R	O	G	R	A	M		M	O	D	E			
2. Depress F1, then F10.
 

T	E	R	M	I	N	A	L		A	S	S	I	G	N
3. Depress F13 (See Note 1).
 

T	E	R	M	•	B	U	S	Y		I	N	/	O	U	T
T	E	L	?	?	?										
4. Enter station number to change its busy out status.  
 Example: Station 104.
 

T	E	R	M	•	B	U	S	Y		I	N	/	O	U	T
T	E	L	1	0	4										
5. Depress line key L1 to assign the desired status to the terminal. (See Note 2).
6. Depress ENTER key. (See Notes 3 & 4).
7. To access port area, depress L13.
 

T	E	R	M	•	B	U	S	Y		I	N	/	O	U	T
M	O	D	?		S	L	O	T	*		C	H	*		
8. To change the port's busy out status, enter module (1~4), slot (1~8), and port (1~4) numbers. Example: Module 1, Slot 8, Port 1.
 

T	E	R	M	•	B	U	S	Y		I	N	/	O	U	T
M	O	D	1		S	L	O	T	8		C	H	1		
9. Depress L1 to change the status of the selected port. (See Note 2).
10. Depress ENTER key. (See Notes 3 & 4).
11. To access DSS/BLF area, depress L14.
 

T	E	R	M	•	B	U	S	Y		I	N	/	O	U	T
D	S	S	/	B	L	F	?								
12. Enter DSS/BLF number 1~6 to change its busy out status. Example: DSS/BLF 2.
 

T	E	R	M	•	B	U	S	Y		I	N	/	O	U	T
D	S	S	/	B	L	F	2								
13. Depress L1 to change the status of the selected DSS/BLF. (See Note 2).
14. Depress ENTER key. (See Notes 3 & 4).
15. To access modem area, depress L12.  
 (CPU-EB or higher).
 

T	E	R	M	•	B	U	S	Y		I	N	/	O	U	T
M	O	D	E	M	?										
16. Enter modem number (1~4) to change its Busy Out status. Example: MODEM 1
 

T	E	R	M	•	B	U	S	Y		I	N	/	O	U	T
M	O	D	E	M	1										
17. Depress L1 to change the status of the selected modem. (See Note 2).
18. Depress ENTER key. (See Notes 3 & 4).
19. Depress TEL # key and repeat steps 4 thru 18 as required to access a specific port or device to check and/or change its Busy Out status.
20. Depress SPKR key to go back on line.

**KEY FUNCTION (OFF LINE)**

<b>SPKR</b> - ON/OFF Line
<b>TEL #</b> - Selects port/device to be assigned
<b>F/W (Forward)</b> - Increments port/device number
<b>CLEAR</b> -
<b>ENTER</b> - Enters each port/device assignment
<b>B/W (Backward)</b> - Decrements port/device number

**GUIDE TO FEATURE PROGRAMMING**

MEMORY BLOCK BEING PROGRAMMED	MEMORY BLOCK THAT MUST BE PROGRAMMED	MEMORY BLOCK THAT MAY HAVE TO BE PROGRAMMED
<b>1E3</b>		<b>4E9</b>

All CPU levels. (See Step 15.)

**NOTES:**

- There are four terminal busy out assignment modes: Station, Port, DSS/BLF and Modem. When entering Memory Block 1E3, the programming station will default to station busy out assignment.
- After specifying the port device by station number, DSS/BLF number, modem number, or by port location, L1 is set to assign a particular status to the port device. L1 indications are as follows:  
 LED ON - Port Not Busied Out  
 LED Flash - Port Busied Out  
 LED OFF - Port Not Assigned
- Program changes are not accepted when:
  - Multiline Terminal
    - is unplugged
    - is not idle
  - DSS/BLF console is unplugged
  - SLT or modem is not idle
  - A terminal is assigned as a tandem port
- Depressing the ENTER key causes the display to increment to the next device number.

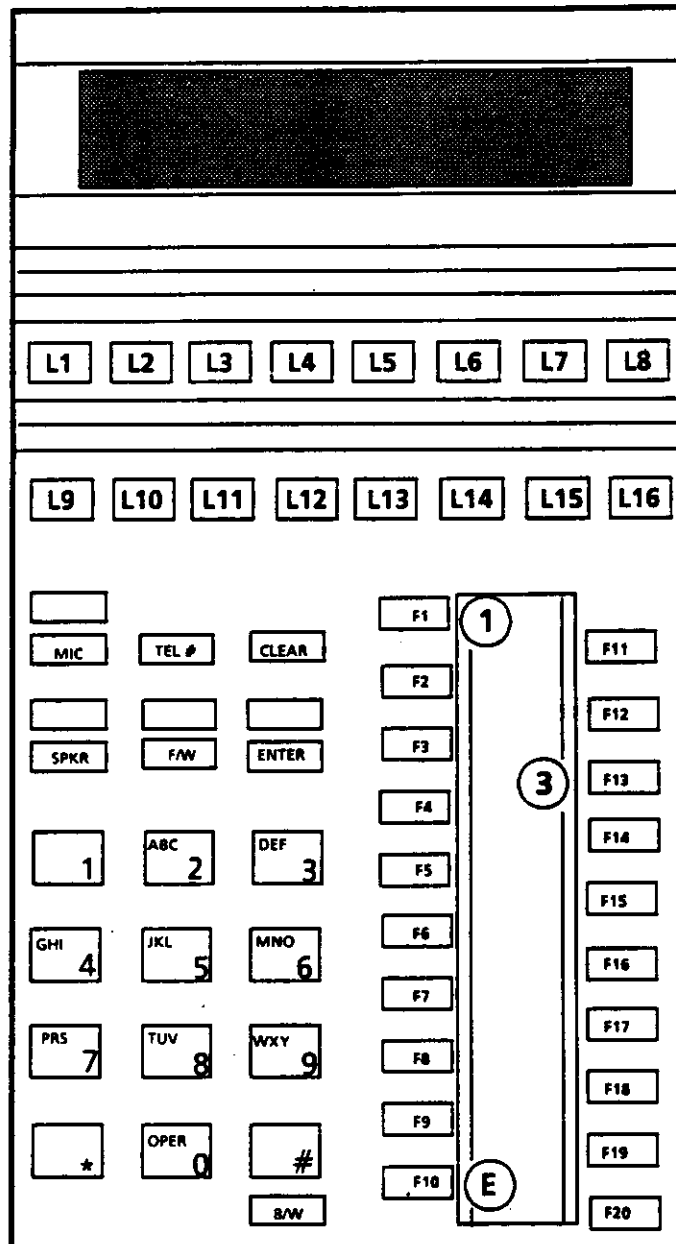

**GENERAL INFORMATION - TERMINAL BUSY ASSIGNMENT**

This area of the memory block is used to busy out or restore port devices including ESI-E( ), SLI-E( ), COI-E( ), TLI-E( ), VMI-E, MFR-E( ) and CNF-E ETUs. The port device can be indexed by port, station number, DSS/BLF device number, or modem device number only.

**MEMORY BLOCK 1E4 - TERMINAL/TELEPHONE INFORMATION**

OPERATION ← AND → DISPLAY

1. Go off line.

	O	F	F	-	L	I	N	E		(	X	.	X	X	)
	P	R	O	G	R	A	M		M	O	D	E			

2. Depress F1, then F10.

T	E	R	M	I	N	A	L		A	S	S	I	G	N	

3. Depress F14. (See Note 1).

T	E	L		I	N	F	O	R	M	A	T	I	O	N	
T	E	L	?	?	?										

4. To determine Telephone/Port assignment, dial station number to be referenced.  
 Example: Station 104. (See Note 2).

T	E	L	1	0	4			D	S	S	5	,	6	,	3
M	O	D	1		S	L	O	T	3		C	H	1		

5. To determine DSS/Port assignment, depress L14.

T	E	L		I	N	F	O	R	M	A	T	I	O	N	
D	S	S	?												

6. Enter DSS device number (1~6).  
 Example: 6. (See Note 3).

D	S	S	6					T	E	L	1	0	0		
M	O	D	1		S	L	O	T	3		C	H	1		

7. To determine device type associated with a particular port, depress L15.

T	E	L		I	N	F	O	R	M	A	T	I	O	N	
M	O	D	?		S	L	O	T	*		C	H	*		

8. Enter port information in order by module, slot, and channel. (See Note 4).  
 Example: Module 1 - Slot 3 - Channel 2.

M	O	D	1		S	L	O	T	3		C	H	2		
T	E	L	1	0	0			D	S	S	5	,	6	,	3

9. Check the information of other stations, ports or modems by using the F/W, B/W, or TEL# keys and going to the step where the desired information is provided.

10. Depress the SPKR key to go back on line.

**KEY FUNCTION (OFF LINE)**

<b>SPKR - ON/OFF Line</b>
<b>TEL # - Select device to be checked</b>
<b>F/W (Forward) - Increment device number</b>
<b>CLEAR -</b>
<b>ENTER -</b>
<b>B/W (Backward) - Decrement device number</b>

**GUIDE TO FEATURE PROGRAMMING**

MEMORY BLOCK BEING PROGRAMMED	MEMORY BLOCK THAT MUST BE PROGRAMMED	MEMORY BLOCK THAT MAY HAVE TO BE PROGRAMMED
<b>1E4</b>		

All CPU levels.

**NOTES:**

1. When entering memory block 1E4, the display will default to station number information.
2. After entering device number by port (or station number) if any DSS/BLF is associated with this terminal, the DSS/BLF will be displayed to the right of the station number. The 3rd DSS number (extreme right) on display indicates the CO Add-On module console number.
3. The display in step 6 shows the port and the associated station for the DSS device entered.
4. The display in step 8 shows the station number and the associated DSS/BLF, if any, related to the port entered.

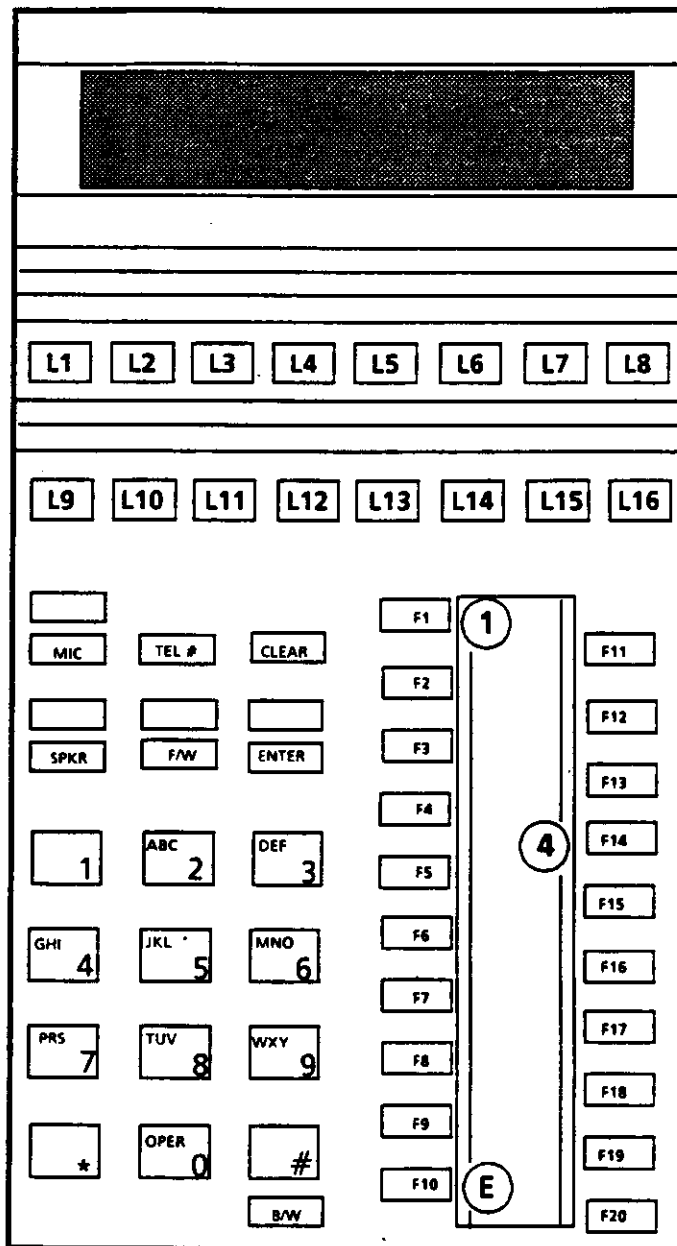

**GENERAL INFORMATION - TERMINAL / TELEPHONE INFORMATION**

This area of the memory block is used to display information on terminal equipment. For any device entered, the memory block will display the station number, DSS number, port location, and DSS/BLF (if one has been assigned). No changes can be made in this memory block, it is used for reference purposes only.

**MEMORY BLOCK 1E5 - PORT INFORMATION**



1. Go off line.

	O	F	F	-	L	I	N	E		(	X	.	X	X	)
	P	R	O	G	R	A	M		M	O	D	E			

2. Depress F1, then F10.

T	E	R	M	I	N	A	L		A	S	S	I	G	N	

3. Depress F15.

P	O	R	T		I	N	F	O	R	M	A	T	I	O	N
M	O	D	?		S	L	O	T	*		C	H	*		

4. Use dial pad and enter module number (1~4) where port is located. Example: Module 2.

P	O	R	T		I	N	F	O	R	M	A	T	I	O	N
M	O	D	2		S	L	O	T	?		C	H	*		

5. Use dial pad and enter slot number (1~8) of chosen module. Example: Slot 7.

P	O	R	T		I	N	F	O	R	M	A	T	I	O	N
M	O	D	2		S	L	O	T	7		C	H	?		

6. Use dial pad and enter channel number (1~4) of chosen slot. Example: Channel 3. (See Note 1).

M	O	D	2		S	L	O	T	7		C	H	3		
X	X	X	X		S	T	-	X						X	X

7. Depress the F/W or B/W or TEL # keys to check any other ports desired.

8. Depress SPKR key to go back on line.

**KEY FUNCTION (OFF LINE)**

SPKR - ON/OFF Line
TEL # - Select port location
F/W (Forward) - Increment port location
CLEAR -
ENTER -
B/W (Backward) - Decrement port location

**GUIDE TO FEATURE PROGRAMMING**

MEMORY BLOCK BEING PROGRAMMED	MEMORY BLOCK THAT MUST BE PROGRAMMED	MEMORY BLOCK THAT MAY HAVE TO BE PROGRAMMED
1E5		

All CPU levels. (See Note 1.)

**NOTES:**

- After port location is entered, the second line of the display will show:

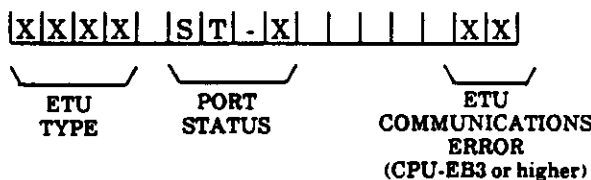

**PORT STATUS**

HARDWARE	SOFTWARE	PORT STATUS
NO	NO	0
NO	YES	1
YES	YES	2

**GENERAL INFORMATION - PORT INFORMATION**

This area of the memory block is used to check the status of a port. When checking the status of a port, three basic items are checked. These are; ETU type, whether the system acknowledges the port through software and hardware and the number of ETU communication errors.

**MEMORY BLOCK 1E6 - TELEPHONE NUMBER EXCHANGE**

OPERATION ← AND → DISPLAY

1. Go off line.

	O	F	F	-	L	I	N	E		(	X	.	X	X	)
	P	R	O	G	R	A	M		M	O	D	E			

2. Depress F1, then F10.

T	E	R	M	I	N	A	L		A	S	S	I	G	N	

3. Depress F16.

T	E	L		N	B	R		E	X	C	H	A	N	G	E
T	E	L	?	?	?		-	-	*	*	*				

4. Dial one of the station numbers to be exchanged.  
 Example = Station 104.

T	E	L		N	B	R		E	X	C	H	A	N	G	E
T	E	L	1	0	4		-	-	?	?	?				

5. Dial the other station number to be exchanged.  
 Example = Station 125.

T	E	L		N	B	R		E	X	C	H	A	N	G	E
T	E	L	1	0	4		-	-	1	2	5				

6. Depress ENTER key. (See Note 1).

T	E	L		N	B	R		E	X	C	H	A	N	G	E
T	E	L	?	?	?		-	-	*	*	*				

7. Repeat steps 4~6 for all additional exchanges.

T	E	L		N	B	R		E	X	C	H	A	N	G	E
T	E	L	?	?	?		-	-	*	*	*				

8. Depress SPKR key to go back on line.



**KEY FUNCTION (OFF LINE)**

SPKR - ON/OFF Line
TEL # - Select station number to exchange
F/W (Forward) -
CLEAR -
ENTER - Enter each number exchange
B/W (Backward) -

**GUIDE TO FEATURE PROGRAMMING**

MEMORY BLOCK BEING PROGRAMMED	MEMORY BLOCK THAT MUST BE PROGRAMMED	MEMORY BLOCK THAT MAY HAVE TO BE PROGRAMMED
1E6		1C3

All CPU levels.  
**NOTES:**

1. Depressing the ENTER key will cause the display to return ??? for additional station entries.
2. DSS/BLF button assignment does not change when a station number is exchanged. The DSS/BLF button assignment stays with the original station.

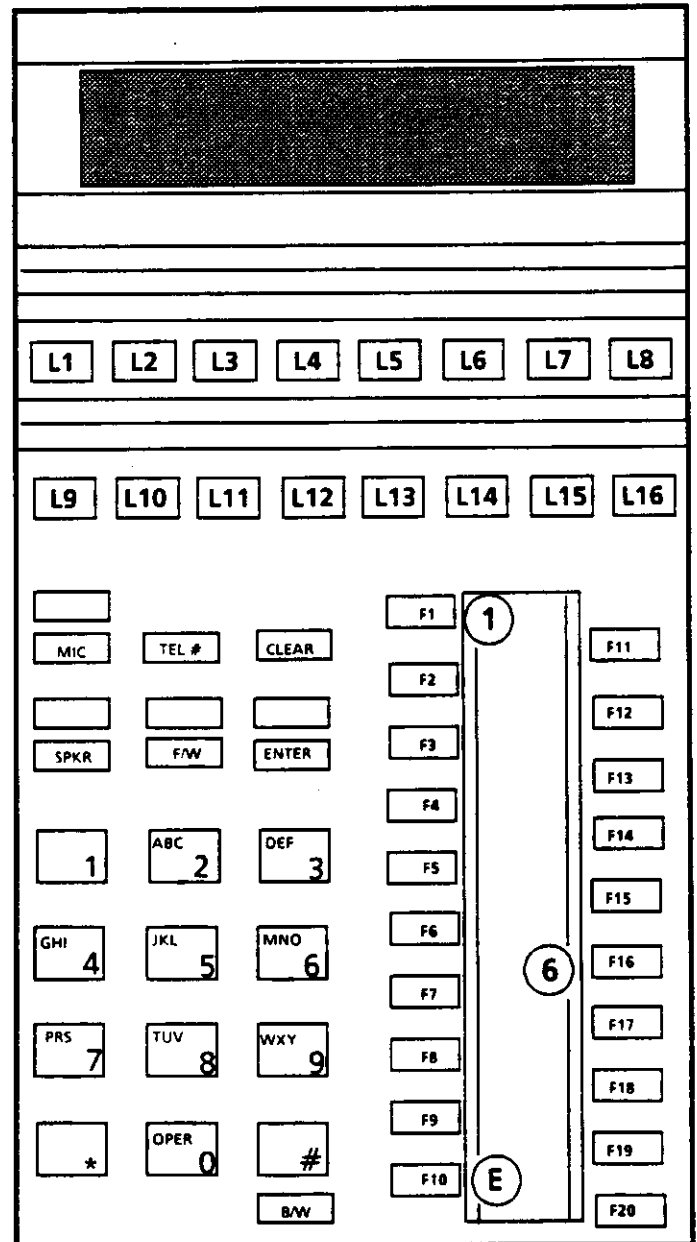

**GENERAL INFORMATION - TELEPHONE NUMBER EXCHANGE**

This area of the memory block is used to exchange the station number between two terminals. It is not necessary that the stations be of the same instrument type.

**MEMORY BLOCK 1E7 - TELEPHONE NUMBER CHANGE**

OPERATION ← AND → DISPLAY

1. Go off line.

	O	F	F	-	L	I	N	E		(	X	.	X	X	)
	P	R	O	G	R	A	M		M	O	D	E			

2. Depress F1, then F10.

T	E	R	M	I	N	A	L		A	S	S	I	G	N	

3. Depress F17.

T	E	L		N	B	R		C	H	A	N	G	E		
T	E	L	?	?	?		-	-		*	*	*			

4. Dial station number to be changed.  
 Example: Station 104.

T	E	L		N	B	R		C	H	A	N	G	E		
T	E	L	1	0	4		-	-		?	?	?			

5. Dial new station number being assigned.  
 Example: Station 304. (See Note 1).

T	E	L		N	B	R		C	H	A	N	G	E		
T	E	L	1	0	4		-	-		3	0	4			

6. Depress ENTER key. (See Note 2).

T	E	L		N	B	R		C	H	A	N	G	E		
T	E	L	?	?	?		-	-		*	*	*			

7. Repeat steps 4 to 6 for all additional changes.

8. Depress SPKR key to go back on line.

**KEY FUNCTION (OFF LINE)**

SPKR - ON/OFF Line
TEL # - Select station number to change
F/W (Forward) -
CLEAR -
ENTER - Enter each number change
B/W (Backward) -

**GUIDE TO FEATURE PROGRAMMING**

MEMORY BLOCK BEING PROGRAMMED	MEMORY BLOCK THAT MUST BE PROGRAMMED	MEMORY BLOCK THAT MAY HAVE TO BE PROGRAMMED
1E7		2E1

All CPU levels.

**NOTES:**

1. In step 5 if a station number which is already assigned is dialed, the system will not allow it to be entered.
2. Depressing the ENTER key will cause the display to return to ??? for additional station entries.
3. A programming station cannot change its own number.

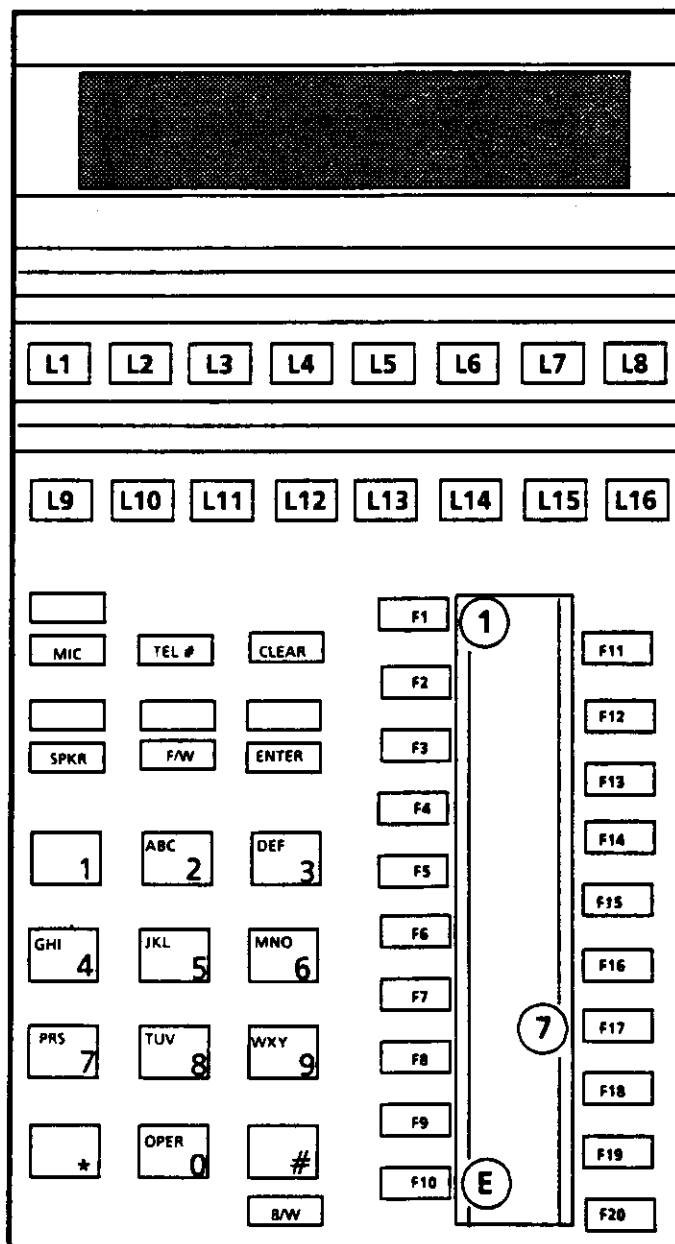

**GENERAL INFORMATION - TELEPHONE NUMBER CHANGE**

This area of the memory block is used to reassign a station number to a terminal. The new number chosen cannot already be assigned elsewhere.

**MEMORY BLOCK 2A1 - PROGRAMMING TERMINAL**

OPERATION ← AND → DISPLAY

1. Go off line.

	O	F	F	-	L	I	N	E		(	X	.	X	X	)
	P	R	O	G	R	A	M		M	O	D	E			

2. Depress F2.

S	Y	S	T	E	M		1								

3. Depress F6.

S	Y	S	.		F	E	A	T	U	R	E	1			

4. Depress F11. (See Note 1).

P	R	O	G	R	A	M	M	I	N	G		T	E	L	
T	E	L		N	U	M	B	E	R		?	?	?		

5. Dial station number to be assigned.  
 Example: Station 104. (See Note 2).

P	R	O	G	R	A	M	M	I	N	G		T	E	L	
T	E	L		N	U	M	B	E	R		?	?	?		

6. Depress ENTER key.

7. Depress SPKR key to go back on line.

**KEY FUNCTION (OFF LINE)**

SPKR - ON/OFF Line
TEL # -
F/W (Forward) -
CLEAR - Clear previous entry
ENTER - Enter new station number
B/W (Backward) -

**GUIDE TO FEATURE PROGRAMMING**

MEMORY BLOCK BEING PROGRAMMED	MEMORY BLOCK THAT MUST BE PROGRAMMED	MEMORY BLOCK THAT MAY HAVE TO BE PROGRAMMED
2A1		1E2

All CPU levels.  
 NOTES:

1. During step 3 the display will show the previous station assigned.
2. The station number entered must be associated with an ETE-16D-( ) Multiline Terminal.

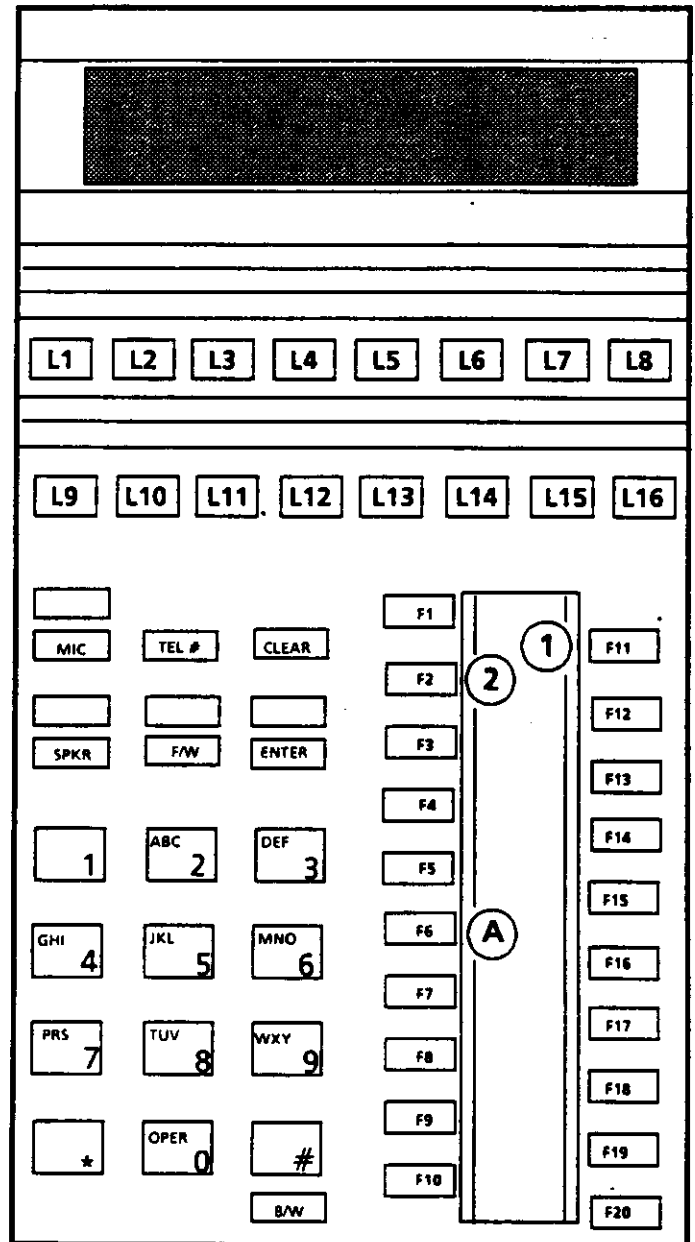

**GENERAL INFORMATION - PROGRAMMING TERMINAL**

This area of the memory block is used to assign an ETE-16D-( ) Multiline Terminal system programming capabilities. Only the first and second system attendants are able to program this memory block. Only one programming station at a time can be off-line.

MEMORY BLOCK 2A2 - SPEED DIAL TENANT ASSIGNMENT

OPERATION ← AND → DISPLAY

1. Go off line.

	O	F	F	-	L	I	N	E		(	X	.	X	X	)
	P	R	O	G	R	A	M		M	O	D	E			

2. Depress F2, then F6.

S	Y	S	.		F	E	A	T	U	R	E	1			

3. Depress F12. (See Note 1).

S	P	D		C	O	D	E	-	3	T	E	N	A	N	T
T	E	N	A	N	T	1		2	0	-	9	9			

4. Enter last speed dial buffer to be assigned to the 1st. tenant. Example: 50. (See Note 2).

S	P	D		C	O	D	E	-	3	T	E	N	A	N	T
T	E	N	A	N	T	2		5	1	-	0	0			

5. Repeat step 4 for each tenant. (Enter 99 for the last tenant assigned).

6. Depress ENTER key.

S	P	D		C	O	D	E	-	3	T	E	N	A	N	T
T	E	N	A	N	T	3		0	0	-	0	0			

**KEY FUNCTION (OFF LINE)**

SPKR - ON/OFF Line
TEL # -
F/W (Forward) -
CLEAR -
ENTER - Enter each tenant assigned
B/W (Backward) -

**GUIDE TO FEATURE PROGRAMMING**

MEMORY BLOCK BEING PROGRAMMED	MEMORY BLOCK THAT MUST BE PROGRAMMED	MEMORY BLOCK THAT MAY HAVE TO BE PROGRAMMED
2A2		2A3, 3A2

All CPU levels.

**NOTES:**

1. During step 3 the display will show the previous number of tenant assigned to the buffer locations.
2. Buffer number must be within the range of 20 to 99.
3. A maximum of three tenants can be assigned.

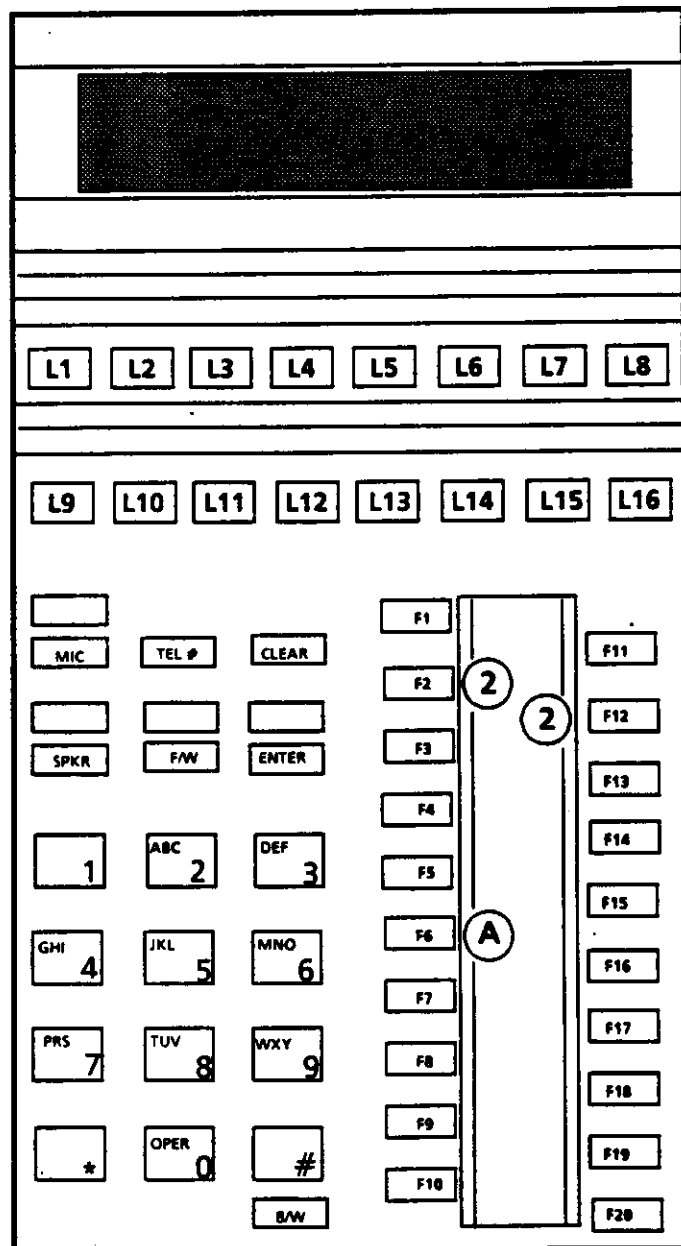

**GENERAL INFORMATION - SPEED DIAL TENANT ASSIGNMENT**

This area of the memory block is used to allocate (in blocks) the *system speed dial* buffers (20 to 99) to each of the system's tenants. A maximum of *three tenants* can be assigned and the buffer numbers of each tenant are not allowed to overlap.

**MEMORY BLOCK 2A3 - SPEED DIAL OVERRIDE ASSIGNMENT**

OPERATION ← AND → DISPLAY

1. Go off line.

	O	F	F	-	L	I	N	E		(	X	.	X	X	)
	P	R	O	G	R	A	M		M	O	D	E			

2. Depress F2, then F6.

S	Y	S	.		F	E	A	T	U	R	E	1			

3. Depress F13.

S	P	D		O	V	E	R	R	I	D	E				
T	E	N	A	N	T	?									

4. Dial tenant number to be assigned (1~3).  
 Example: Tenant 1. (See Note 1).

S	P	D		O	V	E	R	.			T	N	O	1	
S	P	D	2	0	-	X	X				2	0	-	X	X

5. Enter last system buffer location to be allowed to  
 override 1st. tenant toll restriction. Example: 56.

S	P	D		O	V	E	R	.			T	N	O	1	
S	P	D	2	0	-	X	X				2	0	-	5	6

6. Depress ENTER key. (See Note 2).

S	P	D		O	V	E	R	.			T	N	O	2	
S	P	D	Y	Y	-	Z	Z				Y	Y	-	Z	Z

7. Repeat steps 5 and 6 for each tenant as needed.

8. Depress the SPKR key to go back on line.



**KEY FUNCTION (OFF LINE)**

<b>SPKR</b> - ON/OFF Line
<b>TEL #</b> - Select tenant to be programmed
<b>F/W (Forward)</b> - Increment tenant number
<b>CLEAR</b> - Clear number of speed dial buffer
<b>ENTER</b> - Enter completed tenant assignment
<b>B/W (Backward)</b> - Decrement tenant number

**GUIDE TO FEATURE PROGRAMMING**

MEMORY BLOCK BEING PROGRAMMED	MEMORY BLOCK THAT MUST BE PROGRAMMED	MEMORY BLOCK THAT MAY HAVE TO BE PROGRAMMED
<b>2A3</b>	<b>2A2</b>	

All CPU levels.

**NOTES:**

1. When the tenant number is entered, the display will show current information assigned.

**VV-XX** Total SPD dial buffer area assigned.  
**VV-ZZ** SPD dial buffer area to override toll restrictions.

2. When the last buffer number to override is dialed, the display will increment to the next tenant.

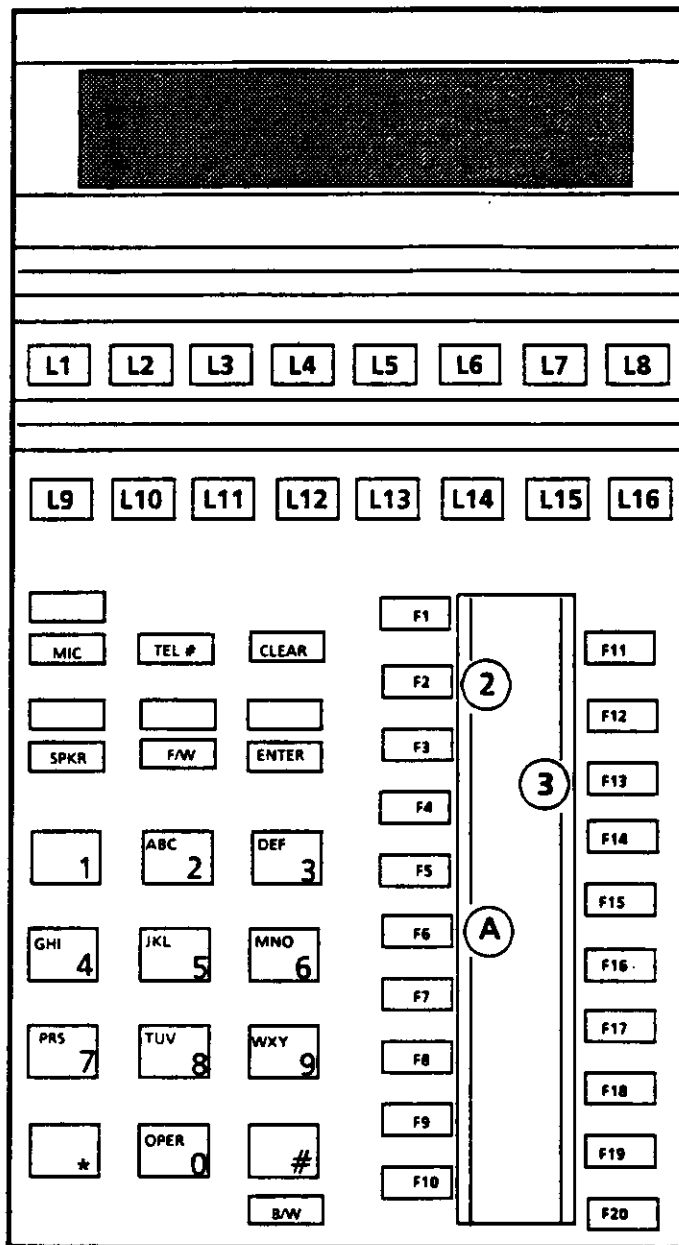

**GENERAL INFORMATION - SPEED DIAL OVERRIDE ASSIGNMENT**

This area of the memory block is used to assign certain areas of the *system speed dial* memory which will *override any code restrictions* already programmed, for each tenant.

**MEMORY BLOCK 2A4 - INCOMING PRIME LINE PICKUP**

OPERATION ← AND → DISPLAY

1. Go off line.

	O	F	F	-	L	I	N	E		(	X	.	X	X	)
	P	R	O	G	R	A	M		M	O	D	E			

2. Depress F2, then F6.

S	Y	S	.		F	E	A	T	U	R	E	1			

3. Depress F14.

I	N	C	O	M	.		P	R	I	M	E	.	L		

4. Depress line key (L1) to set feature as required.  
 (See Note 1).

I	N	C	O	M	.		P	R	I	M	E	.	L		

5. Depress ENTER key.

6. Depress SPKR key to go back on line.

**KEY FUNCTION (OFF LINE)**

SPKR - ON/OFF Line
TEL # -
F/W -
CLEAR -
ENTER - Enter option
B/W -

**GUIDE TO FEATURE PROGRAMMING**

MEMORY BLOCK BEING PROGRAMMED	MEMORY BLOCK THAT MUST BE PROGRAMMED	MEMORY BLOCK THAT MAY HAVE TO BE PROGRAMMED
2A4		1A, 1D1

All CPU levels.  
 NOTES:

- To allow the incoming prime line pickup feature, L1 must be lit before the ENTER key is depressed. To deny the feature, L1 must be off.

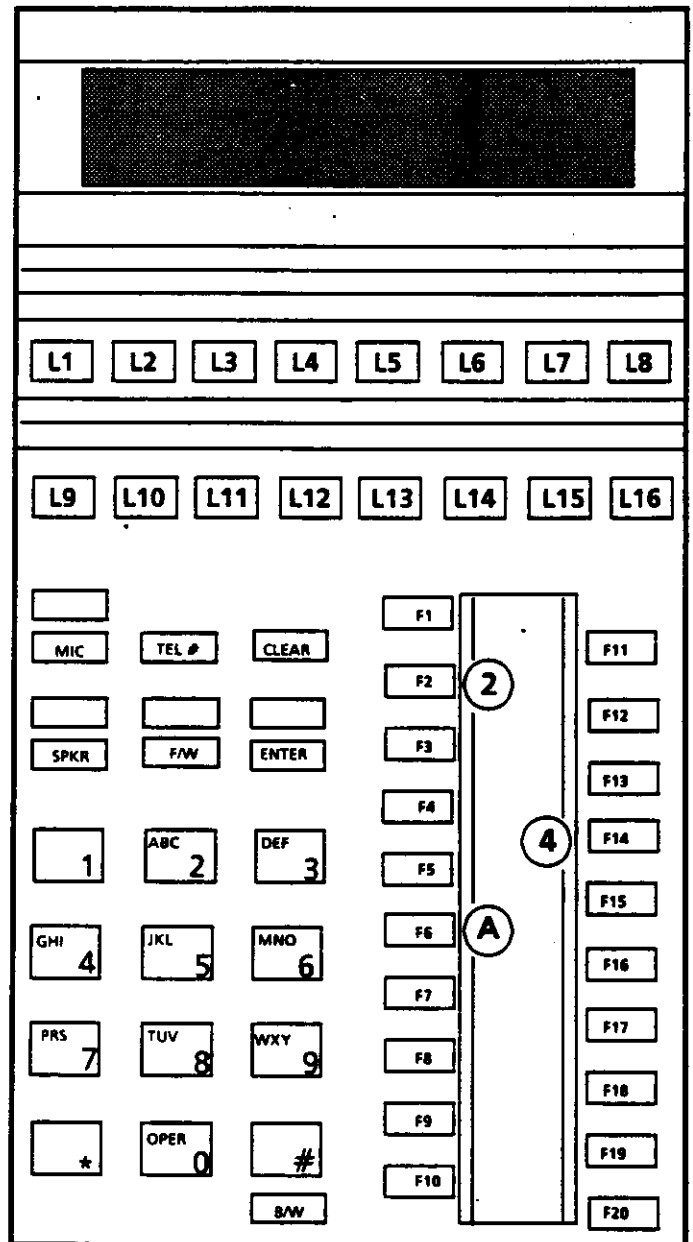

**GENERAL INFORMATION - INCOMING PRIME LINE PICKUP**

This area of the memory block is used to allow or deny the incoming prime line pickup feature (see Section 400 for the operation of this feature) on a system wide basis.

**MEMORY BLOCK 2A5 - CO \* AND # AS FIRST DIGIT ASSIGNMENT**

OPERATION ← AND → DISPLAY

1. Go off line.

	O	F	F	-	L	I	N	E		(	X	.	X	X	)
	P	R	O	G	R	A	M		M	O	D	E			

2. Depress F2, then F6.

S	Y	S	.		F	E	A	T	U	R	E	1			

3. Depress F15.

*	/	#		1	S	T		D	I	G	I	T			

4. Depress L1 and L2 to allow or disallow \* and/or # to be dialed as a first digit on a CO appearance. (See Note 1).

*	/	#		1	S	T		D	I	G	I	T			

5. Depress ENTER key.

6. Depress SPKR key to go back on line.

**KEY FUNCTION (OFF LINE)**

SPKR - ON/OFF Line
TEL # -
F/W -
CLEAR -
ENTER - Enter option
B/W -

**GUIDE TO FEATURE PROGRAMMING**

MEMORY BLOCK BEING PROGRAMMED	MEMORY BLOCK THAT MUST BE PROGRAMMED	MEMORY BLOCK THAT MAY HAVE TO BE PROGRAMMED
<b>2A5</b>		

All CPU levels.  
**NOTES:**

1. In step 4, L1 and L2 are set to allow or disallow the option according to the following patterns:

**L1**  
 ON • not sent out if first digit  
 OFF • sent out

**L2**  
 ON # not sent out if first digit  
 OFF # sent out

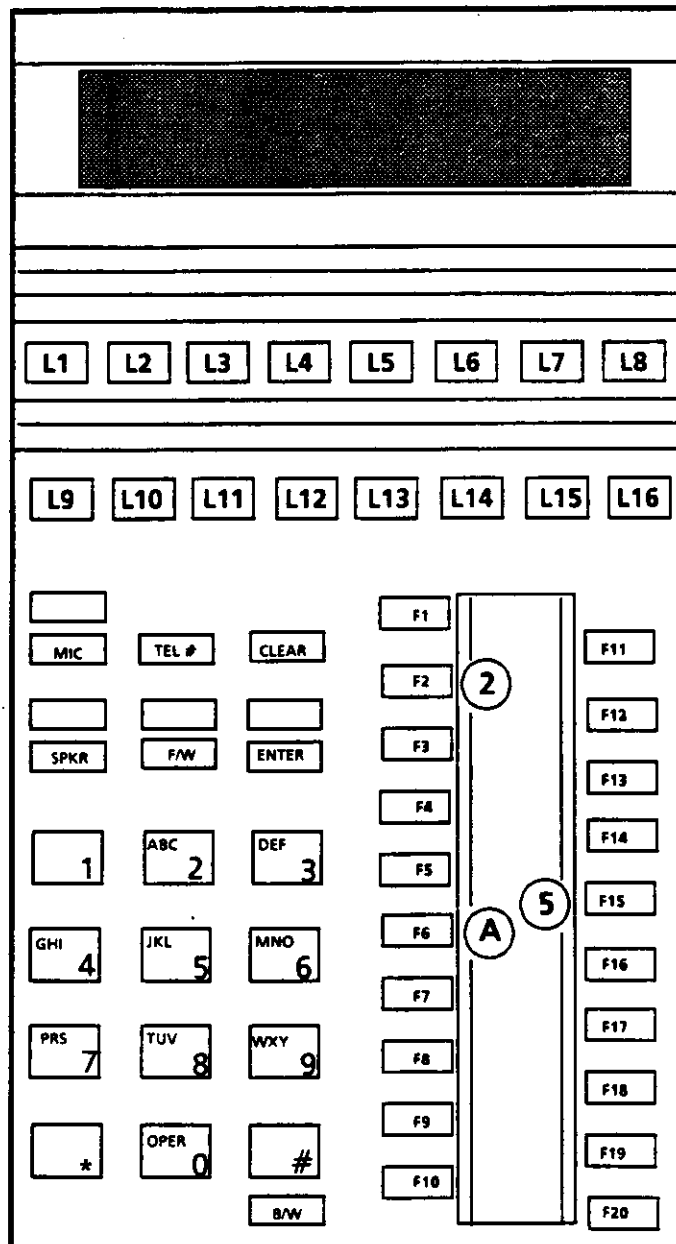

**GENERAL INFORMATION - CO \* AND # AS FIRST DIGIT ASSIGNMENT**

This area of the memory block is used to allow or disallow \* and # from being sent out of the system as the first digit when a station is on an outside line. If the feature is disallowed, dialing \* or # as the first digit will access system features such as last number redial. If allowed, then system speed dial and last number redial can be accessed via the primary extension (LK16).

**MEMORY BLOCK 2A6 - SMDR INCOMING PRINT**

OPERATION ← AND → DISPLAY

1. Go off line.

	O	F	F	-	L	I	N	E		(	X	.	X	X	)
	P	R	O	G	R	A	M		M	O	D	E			

2. Depress F2, then F6.

S	Y	S	.		F	E	A	T	U	R	E	1			

3. Depress F16.

S	M	D	R		P	R	I	N	T						

4. Depress L1 as required to allow or disallow SMDR output. (See Note 1).
5. Depress ENTER key.
6. Depress SPKR key to go back on line.

**KEY FUNCTION (OFF LINE)**

SPKR - ON/OFF Line
TEL # -
F/W -
CLEAR -
ENTER - Enter option
B/W -

**GUIDE TO FEATURE PROGRAMMING**

MEMORY BLOCK BEING PROGRAMMED	MEMORY BLOCK THAT MUST BE PROGRAMMED	MEMORY BLOCK THAT MAY HAVE TO BE PROGRAMMED
<b>2A6</b>		

All CPU levels.

**NOTES:**

1. In step 4, if L1 is on, SMDR output for incoming calls is provided. If L1 is off, SMDR output for incoming calls is not provided.

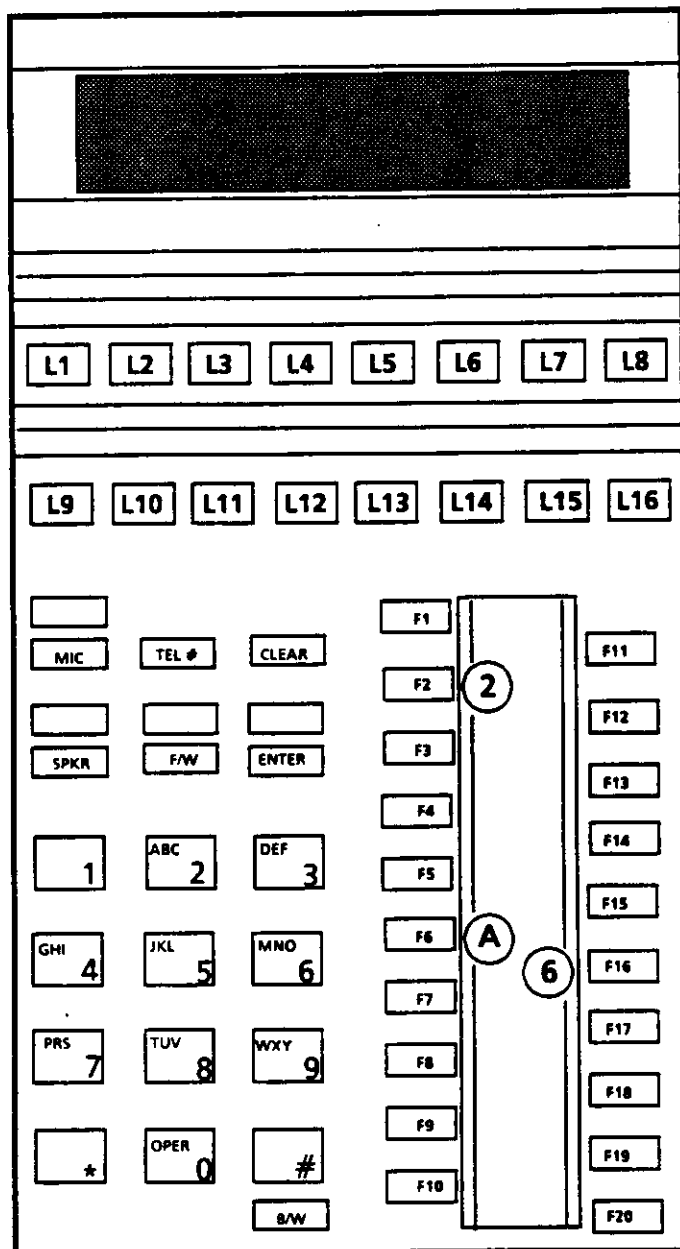

**GENERAL INFORMATION - SMDR INCOMING PRINT**

This area of the memory block is used to allow or disallow the SMDR output for incoming calls.

**MEMORY BLOCK 2A7 - INTERNAL ALL CALL**



1. Go off line.

	O	F	F	.	L	I	N	E		(	X	.	X	X	)
	P	R	O	G	R	A	M		M	O	D	E			

2. Depress F2, then F6.

S	Y	S	.		F	E	A	T	U	R	E	1			

3. Depress F17.

	I	N	T		A	L	L		C	A	L	L			

4. Depress L1 as required to allow or disallow the internal all call feature. (See Note 1).
5. Depress ENTER key.
6. Depress SPKR key to go back on line.



**KEY FUNCTION (OFF LINE)**

SPKR - ON/OFF Line
TEL # -
F/W -
CLEAR -
ENTER - Enter option
B/W -

**GUIDE TO FEATURE PROGRAMMING**

MEMORY BLOCK BEING PROGRAMMED	MEMORY BLOCK THAT MUST BE PROGRAMMED	MEMORY BLOCK THAT MAY HAVE TO BE PROGRAMMED
2A7	-	

All CPU levels.

**NOTES:**

1. In step 4, if L1 is on, the internal all call feature is allowed. If L1 is off (Default), the feature is disallowed.

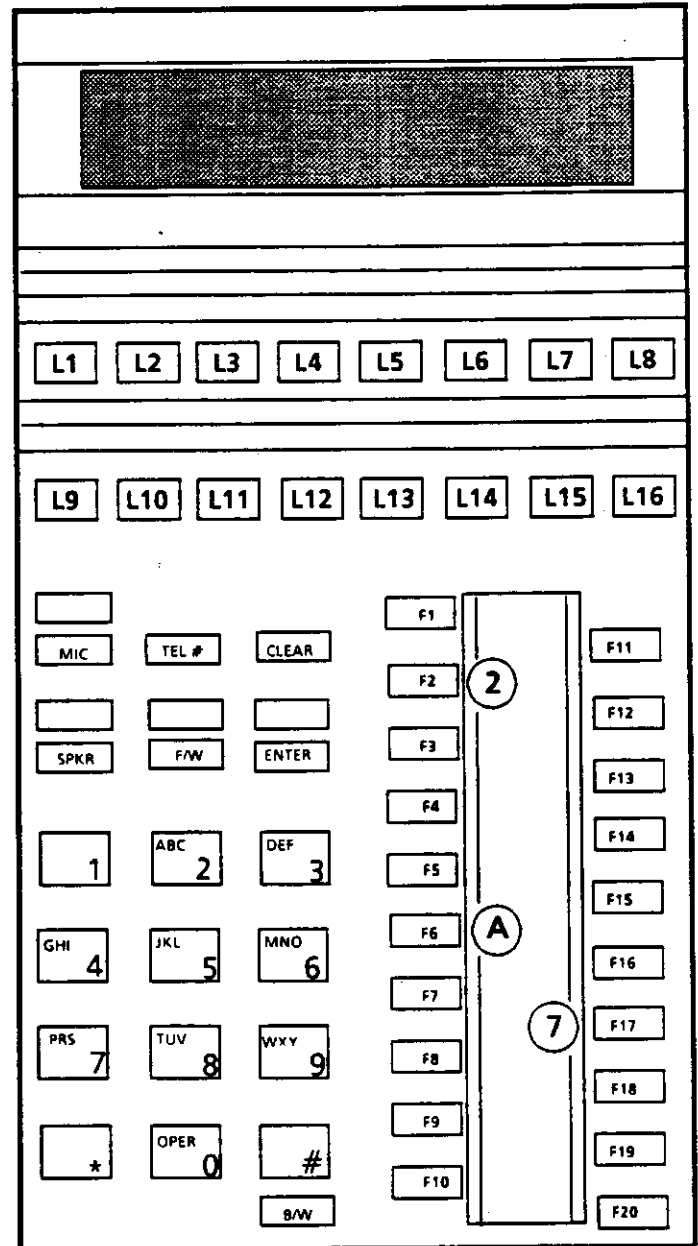

**GENERAL INFORMATION - INTERNAL ALL CALL**

This area of the memory block is used to allow or disallow the internal all call system feature. When active, this feature allows all page calls to reach every multiline station, regardless whether they are programmed into a page zone or not. It is mostly used for emergencies.

**MEMORY BLOCK 2A8 - ACCOUNT CODE DIGIT**

OPERATION ← AND → DISPLAY

1. Go off line.

	O	F	F	-	L	I	N	E		(	X	.	X	X	)
	P	R	O	G	R	A	M		M	O	D	E			

2. Depress F2, then F6.

S	Y	S	.		F	E	A	T	U	R	E	1			

3. Depress F18. (See Note 1).

	A	C	C	O	U	N	T		C	O	D	E			
	D	I	G	I	T	-	X	X							

4. Enter number of digits for the Account Code (01 ~ 14). Example: Enter 09 for a 9 digit account code.

	A	C	C	O	U	N	T		C	O	D	E			
	D	I	G	I	T	-	0	9							

5. Depress ENTER key.
6. Depress the SPKR key to go back on line.

**KEY FUNCTION (OFF LINE)**

SPKR - ON/OFF Line
TEL # -
F/W -
CLEAR -
ENTER - Enter account code digits assignment
B/W -

**GUIDE TO FEATURE PROGRAMMING**

MEMORY BLOCK BEING PROGRAMMED	MEMORY BLOCK THAT MUST BE PROGRAMMED	MEMORY BLOCK THAT MAY HAVE TO BE PROGRAMMED
<b>2A8</b>		

All CPU levels.  
**NOTES:**

1. During step 3, any previous value already set is displayed. Default value is 10 digits.

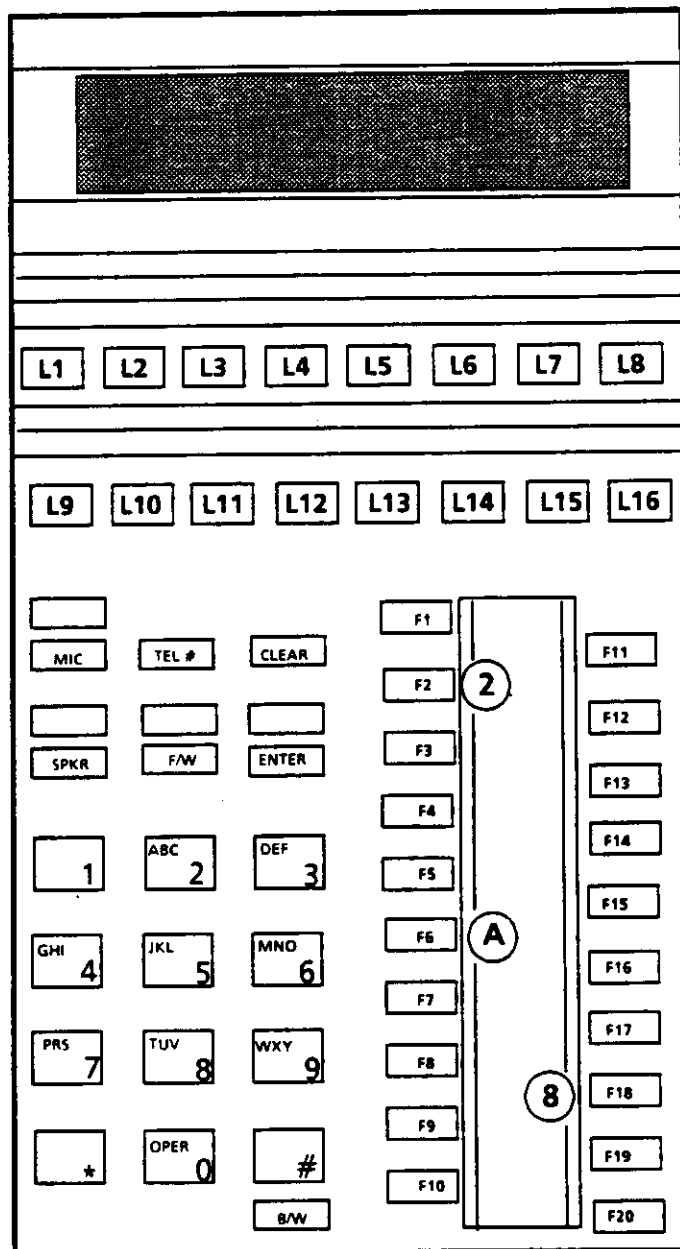

**GENERAL INFORMATION - ACCOUNT CODE DIGIT**

This area of the memory block is used to define the maximum number of digits for account codes. This value can be set from 1 to 14 digits in length.

**MEMORY BLOCK 2A9 - PBX OUTGOING CODE**

OPERATION ← AND → DISPLAY

1. Go off line.

	O	F	F	-	L	I	N	E		(	X	.	X	X	)
	P	R	O	G	R	A	M		M	O	D	E			

2. Depress F2, then F6.

	S	Y	S	.		F	E	A	T	U	R	E	1		

3. Depress F19. (See Note 1).

	P	B	X		O	U	T	G	O	I	N	G			
	C	O	D	E	1	-	-	X							

4. Enter PBX outgoing code. Example: Digit 9.

	P	B	X		O	U	T	G	O	I	N	G			
	C	O	D	E	1	-	-	9							

5. Depress ENTER key. (See Notes 2 and 3).

	P	B	X		O	U	T	G	O	I	N	G			
	C	O	D	E	2	-	-	?							

6. If a second PBX outgoing code is desired, repeat steps 4 and 5.
7. Depress the SPKR key to go back on line.

**KEY FUNCTION (OFF LINE)**

SPKR - ON/OFF Line
TEL # -
F/W - Increment PBX outgoing code number
CLEAR - Clear previous assignment
ENTER - Enter assignment
B/W - Decrement PBX outgoing code number

**GUIDE TO FEATURE PROGRAMMING**

MEMORY BLOCK BEING PROGRAMMED	MEMORY BLOCK THAT MUST BE PROGRAMMED	MEMORY BLOCK THAT MAY HAVE TO BE PROGRAMMED
2A9	4B1, 4B6	

All CPU levels.  
**NOTES:**

1. During step 3, any current PBX outgoing code set for code 1 is displayed.
2. Depressing the ENTER key causes the display to increment to code 2.
3. During step 5, any current outgoing code set for code 2 is displayed.

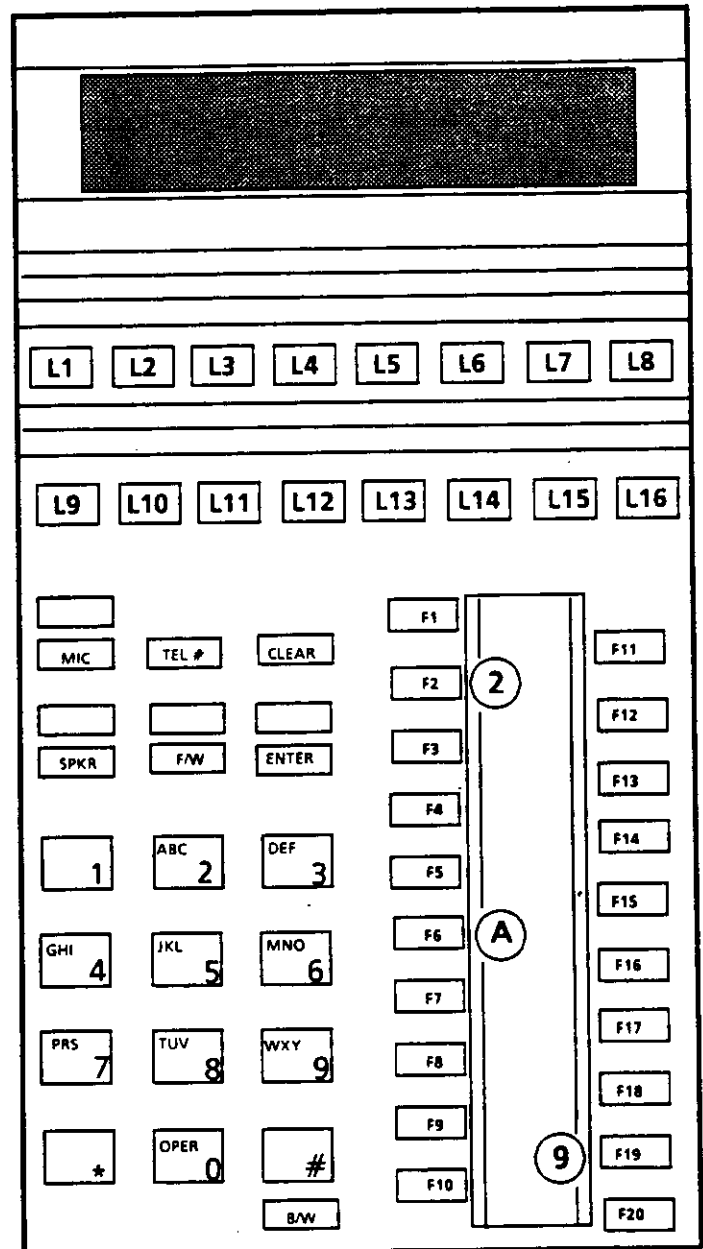

**GENERAL INFORMATION - PBX OUTGOING CODE**

This area of the memory block is used to assign up to *two single digit* PBX outgoing codes. These digits are dialed by a station user on a PBX line to access CO dial tone.

## MEMORY BLOCK 2A10 - TIE LINE DIGIT RESTRICTION ASSIGNMENT

OPERATION ← AND → DISPLAY

1. Go off line.
 

	O	F	F	-	L	I	N	E		(	X	.	X	X	)
	P	R	O	G	R	A	M		M	O	D	E			
  
2. Depress F2, then F6.
 

S	Y	S	.		F	E	A	T	U	R	E	1			
  
3. Depress F20.
 

	T	I	E		D	I	G	I	T		R	E	S	T	.
T	E	L	?	?	?										
  
4. Enter station to be assigned. Example: Station 102. (See Note 1).
 

	T	I	E		D	I	G	I	T		R	E	S	T	.
T	E	L	1	0	2		-		D	I	G	I	T	X	X
  
5. Enter the maximum number of digits (digit string length) that the station will be allowed to dial when using a Tie line (01 ~ 99). (See Note 2).
 

	T	I	E		D	I	G	I	T		R	E	S	T	.
T	E	L	1	0	2		-		D	I	G	I	T	1	2
  
6. Depress ENTER key. (See Note 3).
 

	T	I	E		D	I	G	I	T		R	E	S	T	.
T	E	L	1	0	3		-		D	I	G	I	T	X	X
  
7. Repeat Steps 4 and 5 for all subsequent stations or depress TEL # key to assign a specific station.
  
8. Depress SPKR key to go back on line.

**KEY FUNCTION (OFF LINE)**

SPKR - ON/OFF Line
TEL # - Selects station to be programmed
F/W - Increments station number
CLEAR - Clears previous assignment
ENTER - Enters each assignment
B/W - Decrements telephone number

**GUIDE TO FEATURE PROGRAMMING**

MEMORY BLOCK BEING PROGRAMMED	MEMORY BLOCK THAT MUST BE PROGRAMMED	MEMORY BLOCK THAT MAY HAVE TO BE PROGRAMMED
2A10		4E1 ~ 4E10

CPU-EB or higher.  
**NOTES:**

1. After step 4, the display will show any previous assignment. Default is: ?? (No restriction).
2. Depress the CLEAR key to set no restriction.
3. Depressing the ENTER key will increment the display to the next station number.
4. This digit inspection will occur on all trunk groups associated with Tie lines.

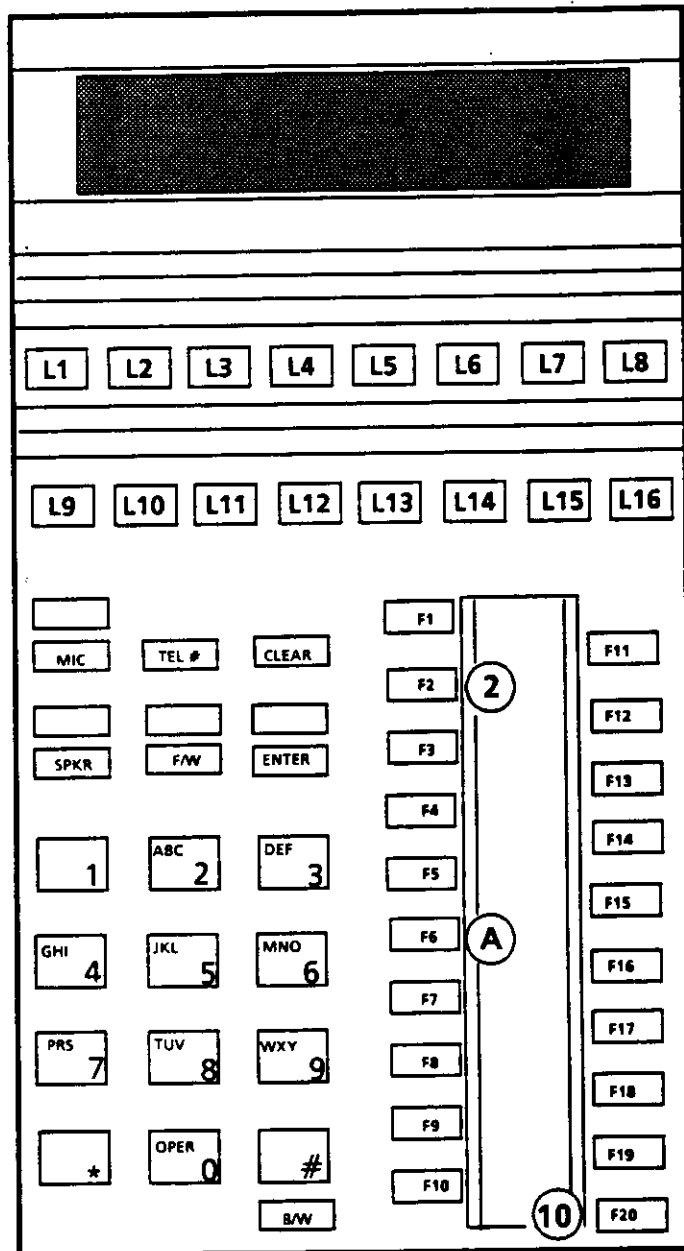

**GENERAL INFORMATION - TIE LINE DIGIT RESTRICTION ASSIGNMENT**

This area of the memory block is used to limit the maximum number of digits that each station is allowed to dial when using a Tie Line.

## MEMORY BLOCK 2B1 - MODEM POOLING / TERMINAL KEYBOARD DIALING ASSIGNMENT

OPERATION ← AND → DISPLAY

1. Go off line.

	O	F	F	-	L	I	N	E		(	X	.	X	X	)
	P	R	O	G	R	A	M			M	O	D	E		

2. Depress F2, then F7.

S	Y	S	.		F	E	A	T	U	R	E	2			

3. Depress F11.

	P	C		D	I	A	L		A	S	S	I	G	N	

4. Depress line key 1 to allow or deny terminal keyboard dialing:

LED ON = Allow  
 LED OFF = Deny

5. Depress ENTER key (See Notes 1 & 2).

6. Depress SPKR key to go back on line.



**KEY FUNCTION (OFF LINE)**

SPKR - ON/OFF Line
TEL # -
F/W -
CLEAR -
ENTER - Enter each assignment
B/W -

**GUIDE TO FEATURE PROGRAMMING**

MEMORY BLOCK BEING PROGRAMMED	MEMORY BLOCK THAT MUST BE PROGRAMMED	MEMORY BLOCK THAT MAY HAVE TO BE PROGRAMMED
<b>2B1</b>	2B7	2D1

CPU-EB2 or higher.

**NOTES:**

1. Default is deny; LED off.
2. The amount of time the modem is reserved is programmable in Time Base Assignment 1.

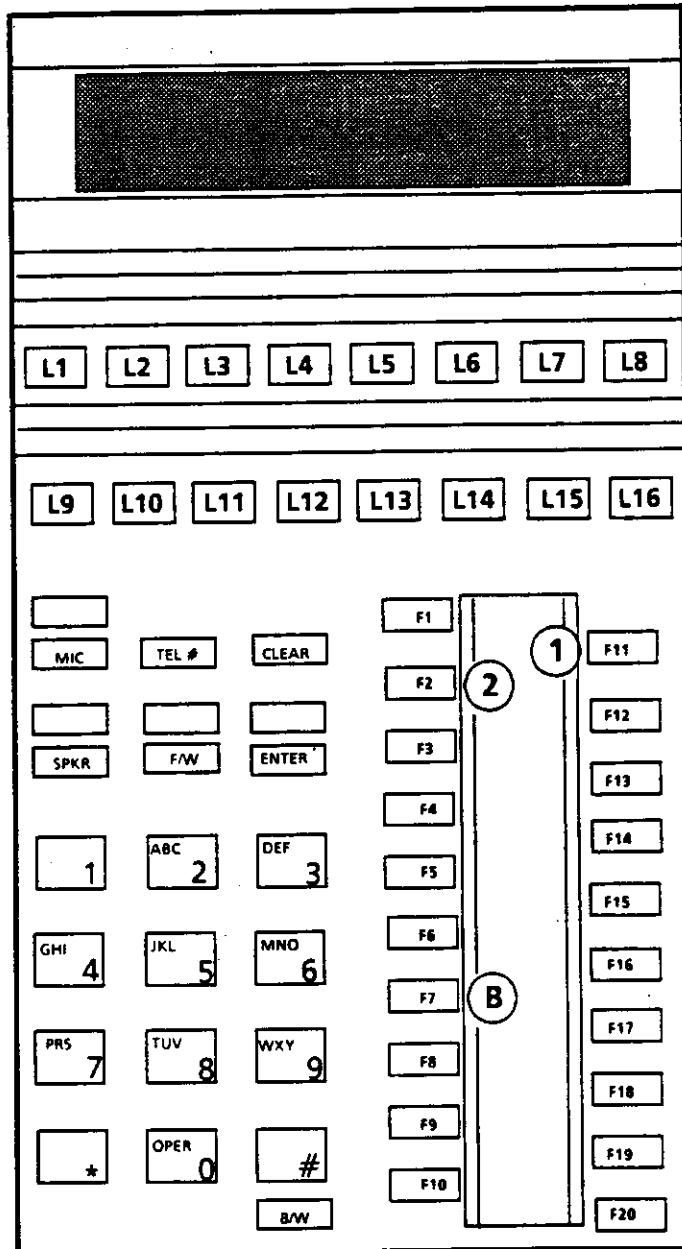

**GENERAL INFORMATION - MODEM POOLING / TERMINAL KEYBOARD  
 DIALING ASSIGNMENT**

This area of the memory block is used to assign (system wide) modem pool access via computer terminal keyboard dialing. This allows data users the ability to reserve modems and then dial out from computer terminals instead of their stations.

**MEMORY BLOCK 2B2 - ALLOW FORWARD OVERRIDE**

OPERATION ← AND → DISPLAY

1. Go off line.

	O	F	F	-	L	I	N	E		(	X	.	X	X	)
	P	R	O	G	R	A	M		M	O	D	E			

2. Depress F2, then F7.

S	Y	S	.		F	E	A	T	U	R	E	2			

3. Depress F12. (See Note 1).

	A	L	L	O	W		F	W	D		O	V	E	R	.

4. Depress L1 to allow or deny forward override.  
 L1 LED ON = Allow  
 L1 LED OFF = Deny

	A	L	L	O	W		F	W	D		O	V	E	R	.

5. Depress ENTER key.

	A	L	L	O	W		F	W	D		O	V	E	R	.

6. Depress the SPKR key to go back on line.

**KEY FUNCTION (OFF LINE)**

SPKR - ON/OFF Line
TÉL # -
F/W -
CLEAR -
ENTER - Enter assignment
B/W -

**GUIDE TO FEATURE PROGRAMMING**

MEMORY BLOCK BEING PROGRAMMED	MEMORY BLOCK THAT MUST BE PROGRAMMED	MEMORY BLOCK THAT MAY HAVE TO BE PROGRAMMED
2B2		1D7

All CPU levels.

**NOTES:**

1. After step 3, line key L1 LED will display the previous assignment.

L1 LED ON = Allow forward override  
 L1 LED OFF = Deny forward override

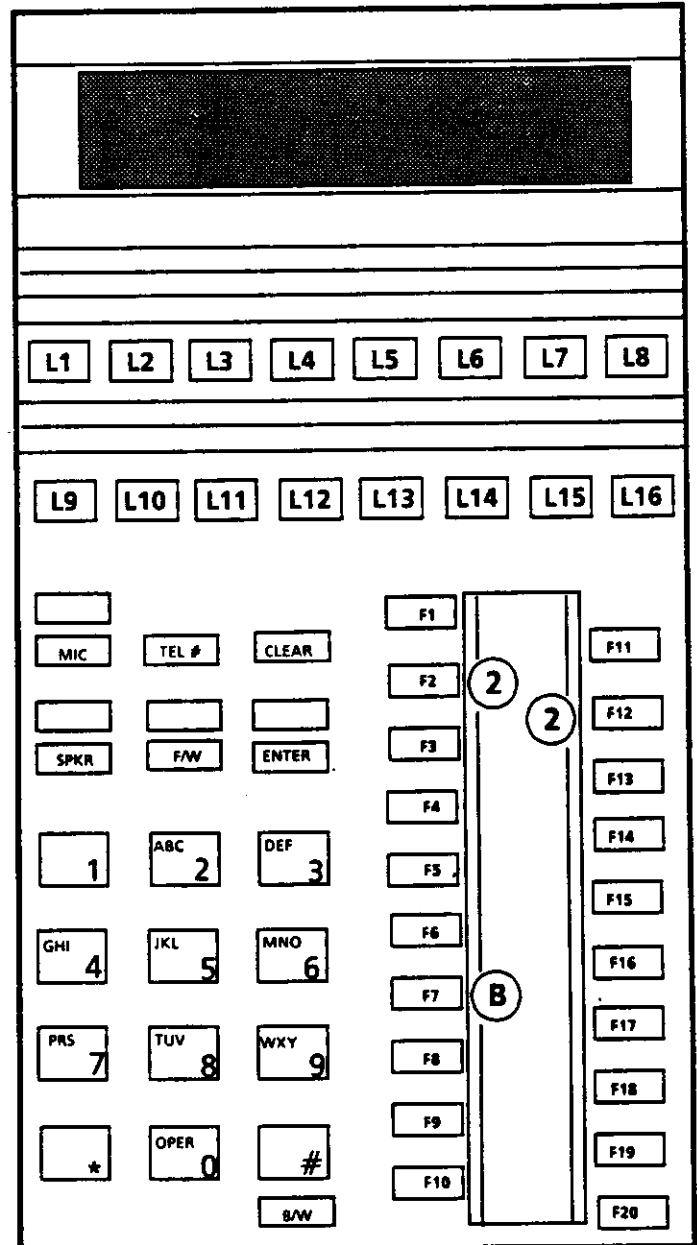

**GENERAL INFORMATION - ALLOW FORWARD OVERRIDE**

This area of the memory block is used to allow or deny (on a system wide basis) the ability to re-direct a call forward previously set to a different target station.

**MEMORY BLOCK 2B3 - DIT TRUNK TO TENANT ASSIGNMENT**

OPERATION ← AND → DISPLAY

1. Go off line.

	O	F	F	-	L	I	N	E		(	X	.	X	X	)
	P	R	O	G	R	A	M			M	O	D	E		

2. Depress F2, then F7.

S	Y	S	.		F	E	A	T	U	R	E	2			

3. Depress F13.

D	I	T		T	R	K		-		T	E	N	A	N	T
T	R	U	N	K	?	?									

4. Enter the trunk number to be assigned (01~40).  
 Example: Trunk 2. (See Note 1).

D	I	T		T	R	K		-		T	E	N	A	N	T
T	R	U	N	K	0	2				T	E	N	A	N	T

5. Enter the tenant number (1~3) to be assigned to the particular trunk. Example: Tenant 2. (See Note 3).

D	I	T		T	R	K		-		T	E	N	A	N	T
T	R	U	N	K	0	2				T	E	N	A	N	T

6. Depress ENTER key. (See Note 2).

D	I	T		T	R	K		-		T	E	N	A	N	T
T	R	U	N	K	0	3				T	E	N	A	N	T

7. Repeat Steps 4 and 5 for all subsequent trunks, or depress TEL # to assign a specific trunk.

8. Depress SPKR key to go back on line.

**KEY FUNCTION (OFF LINE)**

<b>SPKR</b> - ON/OFF Line
<b>TEL #</b> - Enters Trunk number
<b>F/W</b> - Increments Trunk number
<b>CLEAR</b> - Clears previous assignment
<b>ENTER</b> - Enters each assignment
<b>B/W</b> - Decrements Trunk number

**GUIDE TO FEATURE PROGRAMMING**

MEMORY BLOCK BEING PROGRAMMED	MEMORY BLOCK THAT MUST BE PROGRAMMED	MEMORY BLOCK THAT MAY HAVE TO BE PROGRAMMED
<b>2B3</b>	2B4	2C1, 2C2, 3A4

CPU-EB2 or higher.

**NOTES:**

1. Default trunk assignment: All trunks assigned to Tenant 1.
2. Depressing the ENTER key will increment the display to the next trunk number.
3. DIT trunk to tenant assignments should correspond to the same tenants as assigned in Trunk Group to Tenant assignment in Memory Block 2C2.

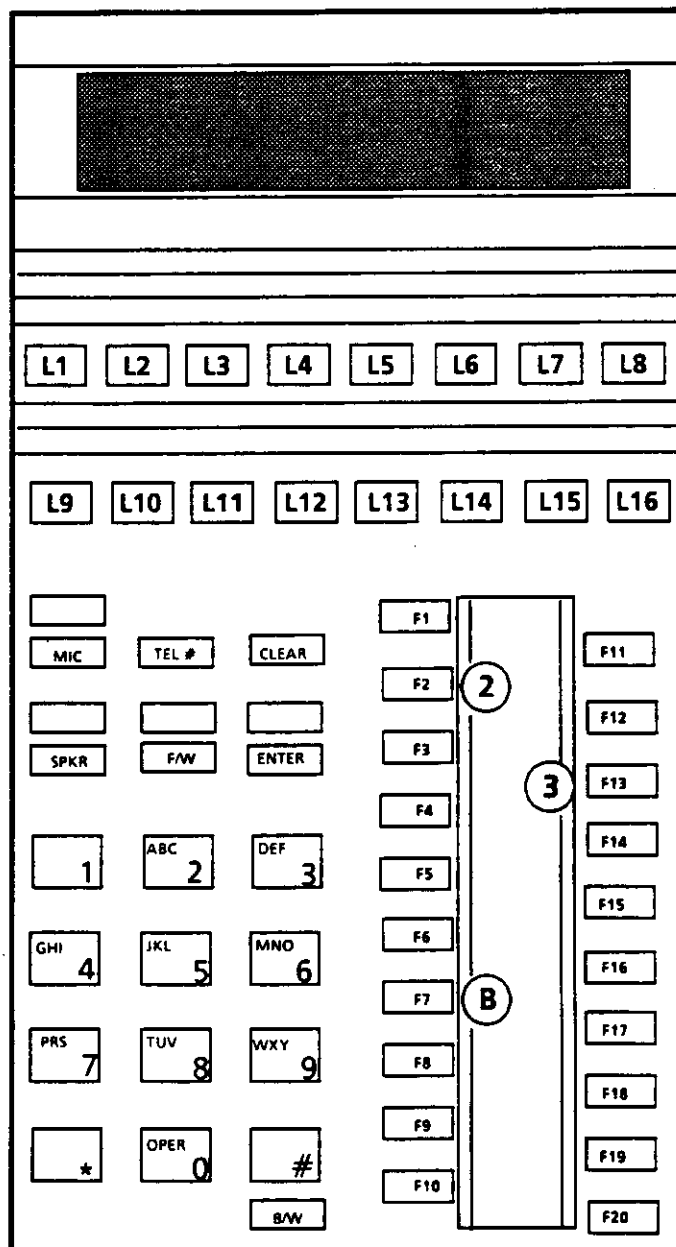

**GENERAL INFORMATION - DIT TRUNK TO TENANT ASSIGNMENT**

This area of the memory block is used to assign DIT trunks to tenants. Each DIT/ANA trunk follows the day/night assignment of its tenant.

**MEMORY BLOCK 2B4 - DIT / ANA ASSIGNMENT**

OPERATION ← AND → DISPLAY

1. Go off line.

	O	F	F	-	L	I	N	E		(	X	.	X	X	)
	P	R	O	G	R	A	M			M	O	D	E		

2. Depress F2, then F7.

S	Y	S	.		F	E	A	T	U	R	E	2			

3. Depress F14.

	D	I	T				D	A	Y		M	O	D	E	
T	R	U	N	K	?	?									

4. Enter the trunk number to be assigned (01~40).  
 Example: Trunk 2. (See Note 1).

	D	I	T				D	A	Y		M	O	D	E	
T	R	U	N	K	0	2			E	X	T	X	X	X	X

5. Enter the extension or station hunting number to be assigned to the chosen trunk. Example: Extension 140. (See Note 3).

	D	I	T				D	A	Y		M	O	D	E	
T	R	U	N	K	0	2			E	X	T	1	4	0	

6. Depress ENTER key. (See Note 2).

	D	I	T				D	A	Y		M	O	D	E	
T	R	U	N	K	0	3			E	X	T	X	X	X	X

7. Repeat Steps 5 and 6 for each DIT trunk required, or depress TEL # to assign a specific trunk.

8. Depressing LK16 alternates the display between DAY and NIGHT modes.

	D	I	T				N	I	G	H	T		M	O	D	E
T	R	U	N	K	0	3			E	X	T	X	X	X	X	

9. Depress SPKR key to go back on line.

**KEY FUNCTION (OFF LINE)**

<b>SPKR</b> - ON/OFF Line
<b>TEL #</b> - Selects trunk to be assigned
<b>F/W</b> - Increments trunk number
<b>CLEAR</b> - Clears previous assignment
<b>ENTER</b> - Enters each assignment
<b>B/W</b> - Decrements trunk number

**GUIDE TO FEATURE PROGRAMMING**

MEMORY BLOCK BEING PROGRAMMED	MEMORY BLOCK THAT MUST BE PROGRAMMED	MEMORY BLOCK THAT MAY HAVE TO BE PROGRAMMED
<b>2B4</b>		1D8, 2B3, 3A4

CPU-EB2 or higher.

**NOTES:**

1. There is no default assignment but any previous extension number that was set will be displayed.
2. Depressing the ENTER key will increment the display to the next trunk.
3. Extension numbers available = 100 ~ 899  
1000 ~ 8999
4. DIT trunks and the terminals where they are terminated should be assigned to the same tenant.
5. DIT trunks do not have to be assigned to line keys (LK1 ~ LK15) unless the trunk is also being used for outgoing calls.
6. DIT and ANA can be assigned to primary, secondary, or virtual extensions, however, they cannot be assigned to a uniform dialing number.

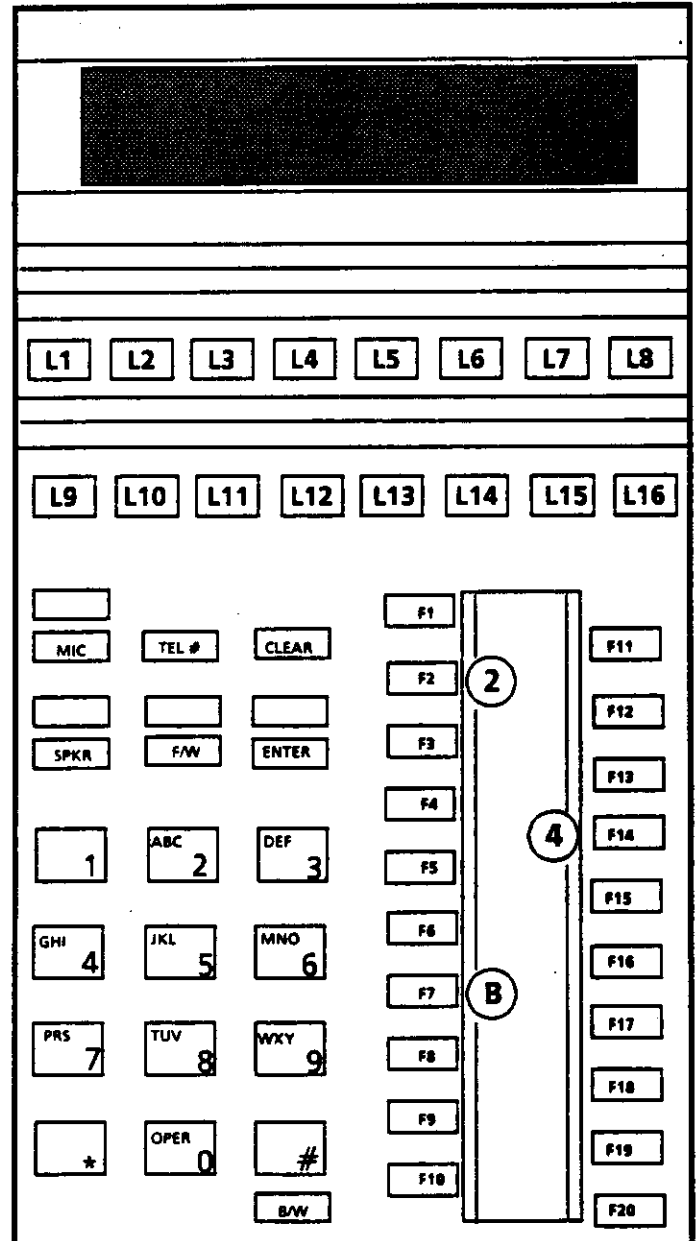

**GENERAL INFORMATION - DIT / ANA ASSIGNMENT**

This area of the memory block is used to independently assign day mode and night mode (ANA) extension terminations to incoming trunk calls. A trunk can terminate at one extension only, but several trunks can be terminated at the same extension.

**MEMORY BLOCK 2B5 - LCR 1+ DIALING ASSIGNMENT**

OPERATION ← AND → DISPLAY

1. Go off line.

	O	F	F	-	L	I	N	E		(	X	.	X	X	)
	P	R	O	G	R	A	M		M	O	D	E			

2. Depress F2, then F7.

S	Y	S	.		F	E	A	T	U	R	E	2			

3. Depress F15. (See Note 1).

	L	C	R			1	+	D	I	A	L				

4. Depress L1 to assign whether or not 1+ dialing is used:  
 L1 LED ON = LCR 1+ Dialing is used  
 L1 LED OFF = LCR 1+ Dialing is *not* used

	L	C	R			1	+	D	I	A	L				

5. Depress the ENTER key.

	L	C	R			1	+	D	I	A	L				

6. Depress the SPKR key to go back on line.



**KEY FUNCTION (OFF LINE)**

SPKR - ON/OFF Line
TEL # -
F/W -
CLEAR -
ENTER - Enter assignment
B/W -

**GUIDE TO FEATURE PROGRAMMING**

MEMORY BLOCK BEING PROGRAMMED	MEMORY BLOCK THAT MUST BE PROGRAMMED	MEMORY BLOCK THAT MAY HAVE TO BE PROGRAMMED
2B5	1D7	2B6, 2B5

All CPU levels.  
 NOTES:

- After step 3, line key L1 LED will display the current assignment.

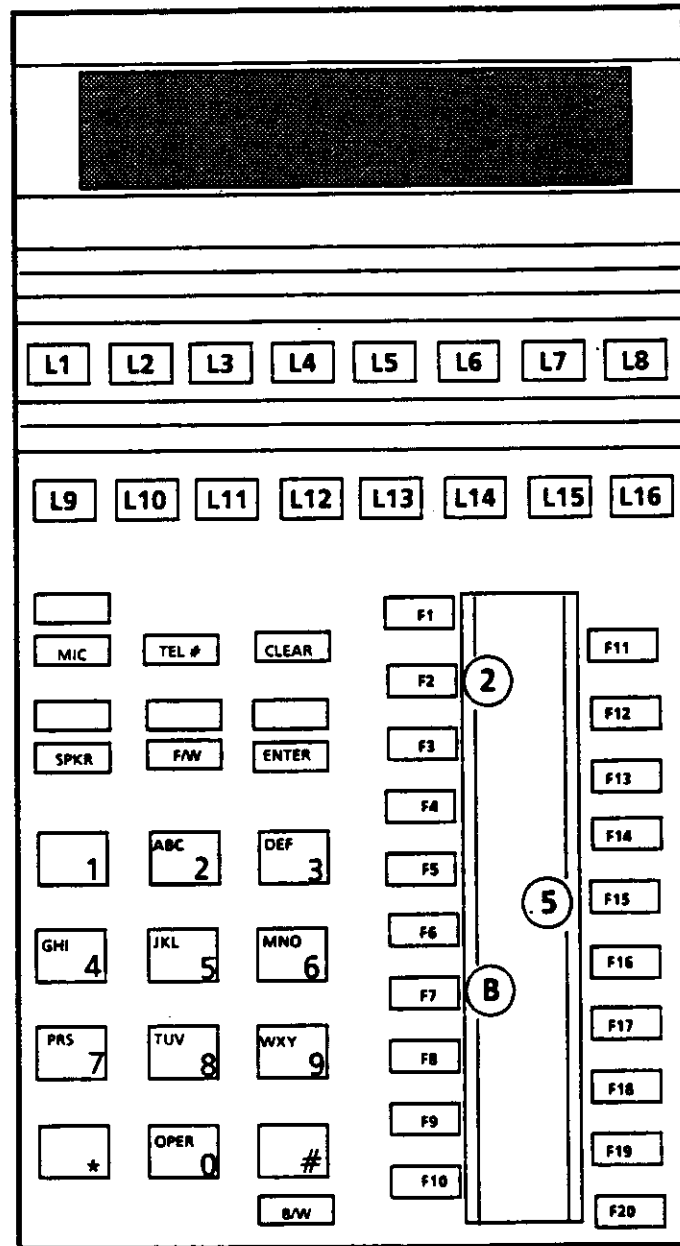

**GENERAL INFORMATION - LCR 1 + DIALING ASSIGNMENT**

This area of the memory block is used to provide the LCR-E ETU with the information whether or not the system is in a 1+ dialing area.

### MEMORY BLOCK 2B6 - LCR LOCAL CALL OVERRIDE ASSIGNMENT

OPERATION ← AND → DISPLAY

1. Go off line.

	O	F	F	-	L	I	N	E		(	X	.	X	X	)
	P	R	O	G	R	A	M		M	O	D	E			

2. Depress F2, then F7.

S	Y	S	.		F	E	A	T	U	R	E	2			

3. Depress F16. (See Note 1).

L	C	R		L	O	C		C	A	L	L		O	V	E

4. a. Depress L1 to assign whether or not local calls will override LCR:  
 L1 LED ON = Local calls route through LCR  
 L1 LED OFF = Local calls override (by-pass) LCR

L	C	R		L	O	C		C	A	L	L		O	V	E

- b. Depress L2 to assign whether or not local calls dialed without a 1+ prefix, in a 1+ area, will bypass LCR:  
 L2 LED ON = Local calls in 1+ area bypass LCR.  
 L2 LED OFF = Local calls do not bypass LCR. (CPU-EB or higher.)

5. Depress ENTER key.

L	C	R		L	O	C		C	A	L	L		O	V	E

6. Depress SPKR key to go back on line.

**KEY FUNCTION (OFF LINE)**

SPKR - ON/OFF Line
TEL # -
F/W -
CLEAR -
ENTER - Enter assignment
B/W -

**GUIDE TO FEATURE PROGRAMMING**

MEMORY BLOCK BEING PROGRAMMED	MEMORY BLOCK THAT MUST BE PROGRAMMED	MEMORY BLOCK THAT MAY HAVE TO BE PROGRAMMED
2B6	1D7	2B5, 2B9

All CPU levels. (See Step 4b.)  
**NOTES:**

1. After step 3, L1 LED will display the previous assignment.

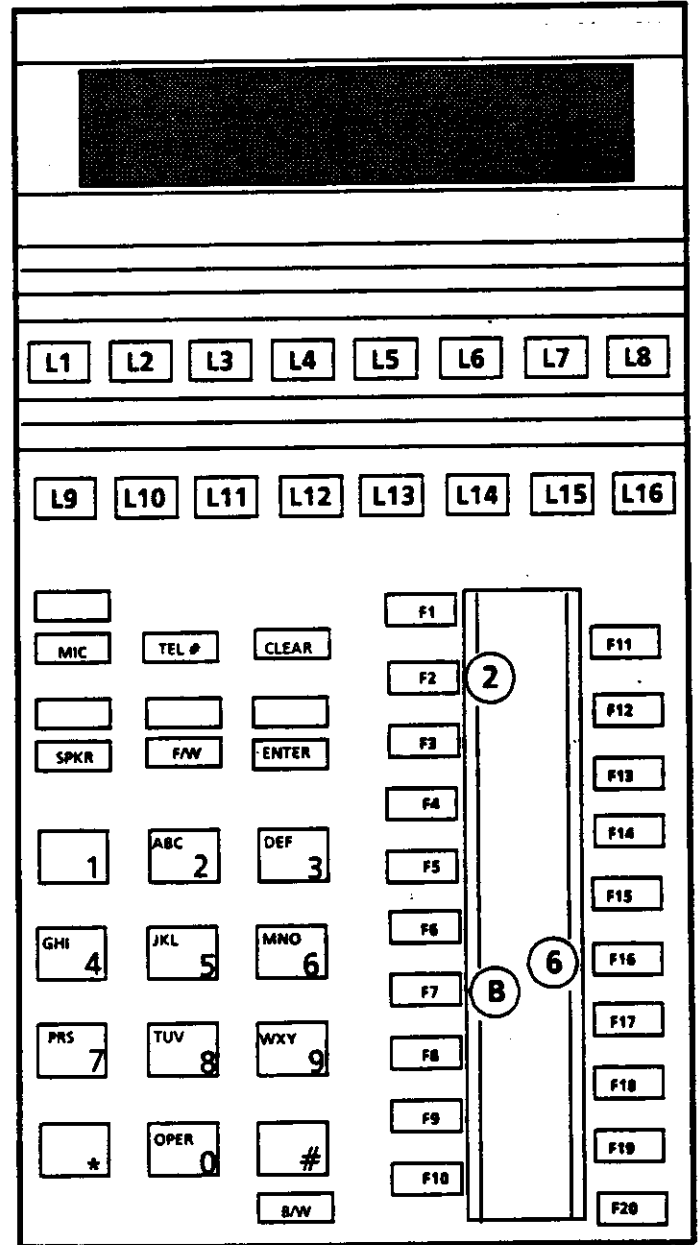

**GENERAL INFORMATION - LCR LOCAL CALL OVERRIDE ASSIGNMENT**

This area of the memory block is used to assign (on a system wide basis) whether or not local calls will override (bypass) LCR. This memory block is also used to assign whether or not the dialing pattern NNX + XXXX is routed through LCR, in a 1 + dial area.

## MEMORY BLOCK 2B7 - MODEM POOL ASSIGNMENTS

OPERATION ← AND → DISPLAY

1. Go off line.
 

	O	F	F	-	L	I	N	E		(	X	.	X	X	)
	P	R	O	G	R	A	M		M	O	D	E			
  
2. Depress F2, then F7.
 

S	Y	S	.		F	E	A	T	U	R	E	2			
  
3. Depress F17.
 

M	O	D	E	M		P	O	O	L		A	S	G	N	
M	O	D	E	M	?										
  
4. Enter the device number of the modem to be assigned (1~4). Example: MODEM 2. (See Note 1).
 

M	O	D	E	M		2		A	S	S	I	G	N		
S	L	T	?	?	?			T	E	R	M	?	?	?	
  
5. Dial the Single Line Telephone station number associated with an SLI port to be assigned to this modem for modem pooling. Example: Station 150.
 

M	O	D	E	M		2		A	S	S	I	G	N		
S	L	T	1	5	0			T	E	R	M	?	?	?	
  
6. Dial the Multiline Terminal station number equipped with a DTA-E unit (and associated with an ESI-EB ETU) to be assigned to this modem for modem pooling. Example: Station 110.
 

M	O	D	E	M		2		A	S	S	I	G	N		
S	L	T	1	5	0			T	E	R	M	1	1	0	
  
7. Depress ENTER key. (See Notes 2 and 3).
 

M	O	D	E	M		3		A	S	S	I	G	N		
S	L	T	?	?	?			T	E	R	M	?	?	?	
  
8. Repeat Steps 5 through 7 for all modems to be assigned for modem pooling or depress TEL# to assign a specific modem.
  
9. Depress SPKR key to go back on line.

**KEY FUNCTION (OFF LINE)**

<b>SPKR</b> - ON/OFF Line
<b>TEL #</b> - Enters modem device number
<b>F/W</b> - Increments modem device number
<b>CLEAR</b> - Clears previous assignment
<b>ENTER</b> - Enters each assignment
<b>B/W</b> - Decrements modem device number

**GUIDE TO FEATURE PROGRAMMING**

MEMORY BLOCK BEING PROGRAMMED	MEMORY BLOCK THAT MUST BE PROGRAMMED	MEMORY BLOCK THAT MAY HAVE TO BE PROGRAMMED
<b>2B7</b>		1A, 1D2, 2B1,
		2D1, 4B4

CPU-EB or higher.  
**NOTES:**

1. After Step 4, the display will show any previous assignments.
2. The assignments made cannot be entered unless both an SLT station number and a TERM. station number have been assigned.
3. Depressing the ENTER key will increment the display to the next Modem Device number.
4. Depressing the CLEAR key clears the SLT and TERM assignment and returns the program to step 4.

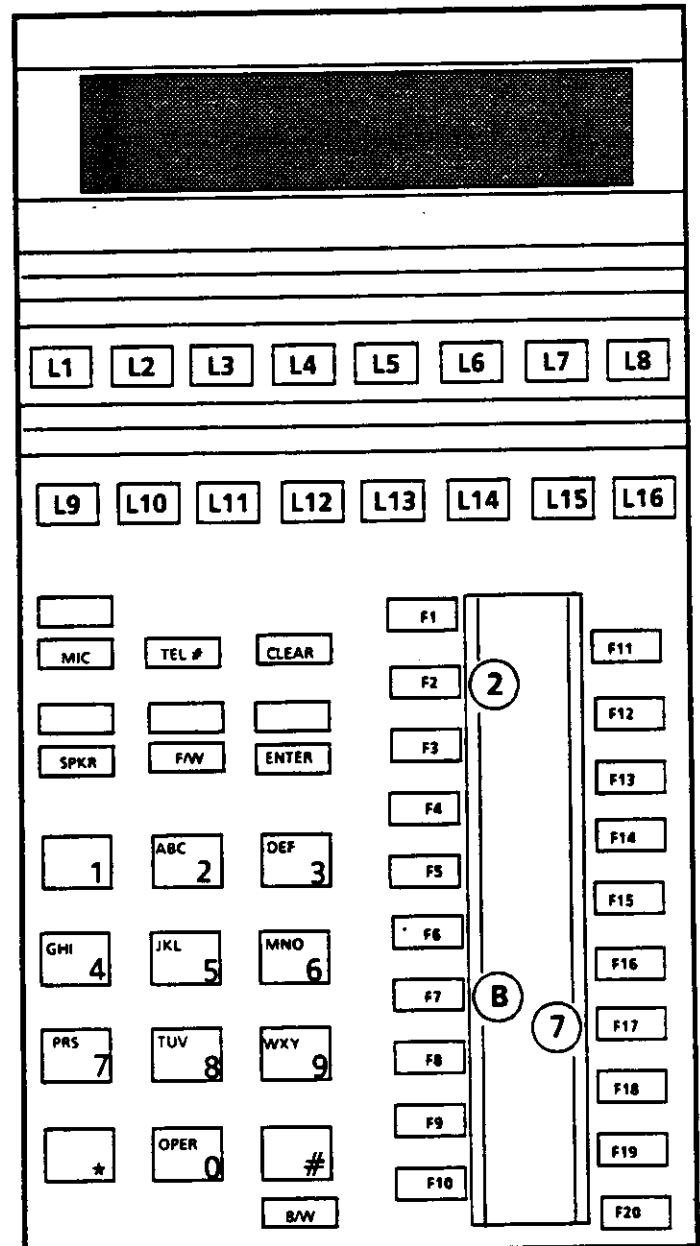

**GENERAL INFORMATION - MODEM POOL ASSIGNMENT**

This area of the memory block is used to assign an SLI or VMI port and a Multiline Terminal equipped with a DTA-E unit (and associated with an ESI-EB ETU) to be used by each modem in the Modem Pool. A maximum of four (4) modems can be assigned to the Modem Pool, with each modem requiring a dedicated SLI or VMI port and Multiline Terminal equipped for data.

## MEMORY BLOCK 2B8 - VMI ASSIGNMENT

OPERATION ← AND → DISPLAY

1. Go off line.

OFF	-	LINE	(	X	.	X	X	)
PROGRAM	MODE							

2. Depress F2, then F7.

S	Y	S	.	F	E	A	T	U	R	E	2		

3. Depress F18.

V	M	I	-	S	L	T	A	S	S	I	G	N
S	E	T	L	I	N	E	K	E	Y	1	-	4

4. Set L1~L4 to assign whether Voice Mail equipment or Single Line Telephones will be connected to each port of the VMI. (See Note 1).

LED ON: Voice Mail (Default)

LED OFF: SLT (CPU-EB or higher)

5. Set L9~L12 to assign whether DTMF tones will, or will not be automatically sent to each of the VMI ports (See Note 2).

LED ON: Send DTMF tones

LED OFF: Do not send DTMF tones (Default) (CPU-EB3 or higher)

6. Depress ENTER key.

7. Depress SPKR key to go back on line.

**KEY FUNCTION (OFF LINE)**

SPKR - ON/OFF Line
TEL # -
F/W -
CLEAR -
ENTER - Enter assignment
B/W -

**GUIDE TO FEATURE PROGRAMMING**

MEMORY BLOCK BEING PROGRAMMED	MEMORY BLOCK THAT MUST BE PROGRAMMED	MEMORY BLOCK THAT MAY HAVE TO BE PROGRAMMED
2B8		4C1

All CPU levels. (See Steps 4 and 5.)

**NOTES:**

1. L1~L4 correspond to VMI ports 1~4 respectively.
2. L9~L12 correspond to VMI ports 1~4 respectively.

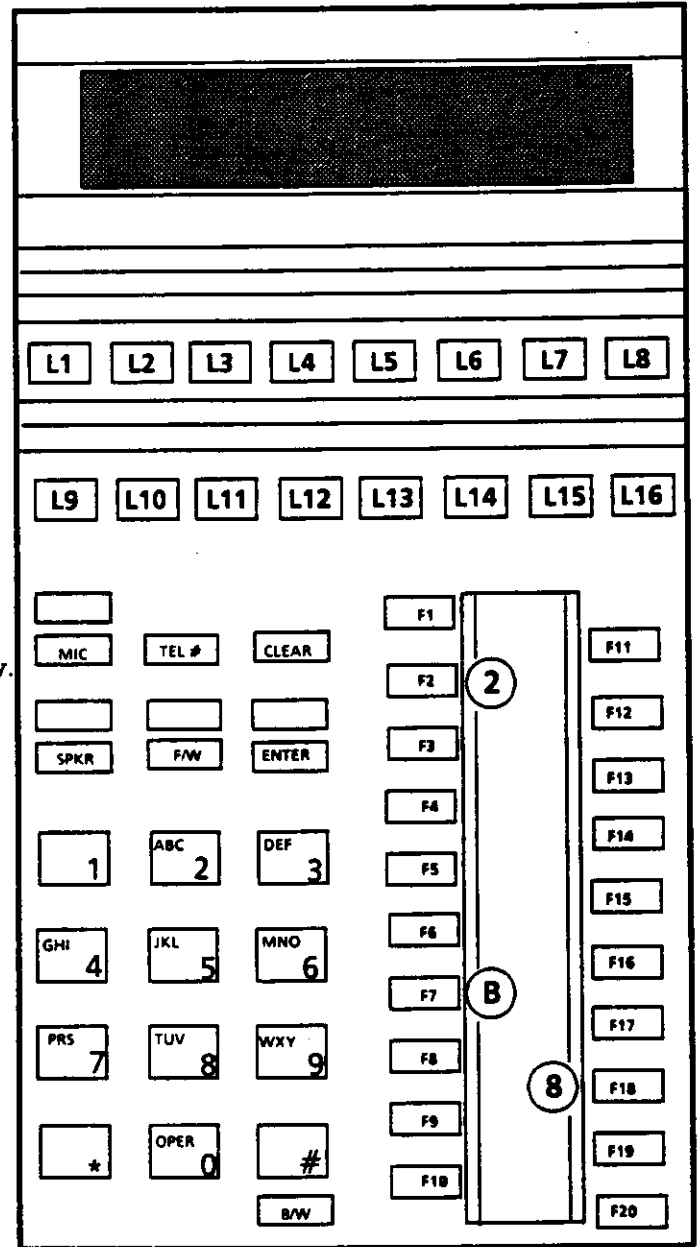

**GENERAL INFORMATION - VMI ASSIGNMENT**

This area of the memory block is used to assign whether Voice Mail equipment or Single Line Telephones will be connected to each of the four (4) VMI ports and whether DTMF tones will be sent or not. The equipment connected determines the dial tone that is provided on hookflash.

**MEMORY BLOCK 2B9 - LCR BYPASS ASSIGNMENT**

OPERATION ← AND → DISPLAY

1. Go off line.

O	F	F	-	L	I	N	E	(	X	.	X	X	)
P	R	O	G	R	A	M		M	O	D	E		

2. Depress F2, then F7.

S	Y	S	.		F	E	A	T	U	R	E	2	

3. Depress F19. (See Note 1).  
 LED ON: Bypass LCR  
 LED OFF: Restricted

	L	C	R		B	Y	P	A	S	S				
S	E	T		L	I	N	E		K	E	Y	2	-	8

4. Depress L2 thru L8 to select which trunk access code groups bypass LCR. (See Note 2).  
 LED ON: Bypass LCR  
 LED OFF: Restricted

5. Depress ENTER key. (See Note 3).

	L	C	R		B	Y	P	A	S	S				
S	E	T		L	I	N	E		K	E	Y	2	-	8

6. Depress SPKR key to go back on line.



**KEY FUNCTION (OFF LINE)**

SPKR - ON/OFF Line
TEL # - Changes Assignment
F/W -
CLEAR -
ENTER - Enters assignment
B/W -

**GUIDE TO FEATURE PROGRAMMING**

MEMORY BLOCK BEING PROGRAMMED	MEMORY BLOCK THAT MUST BE PROGRAMMED	MEMORY BLOCK THAT MAY HAVE TO BE PROGRAMMED
2B9	1D7	2B5, 2B6

CPU-EB or higher.

**NOTES:**

1. After Step 3 line key LED's 2 thru 8 will display the previous assignment. LEDs 2 thru 8 correspond to trunk access code group 2 thru 8.
2. L1 LED is always off and cannot be changed. Attempting to do so results in error tone.
3. Once ENTER is depressed, no further changes can be made. If new changes are required depress F19 again or TEL# key to re-enter the memory block.

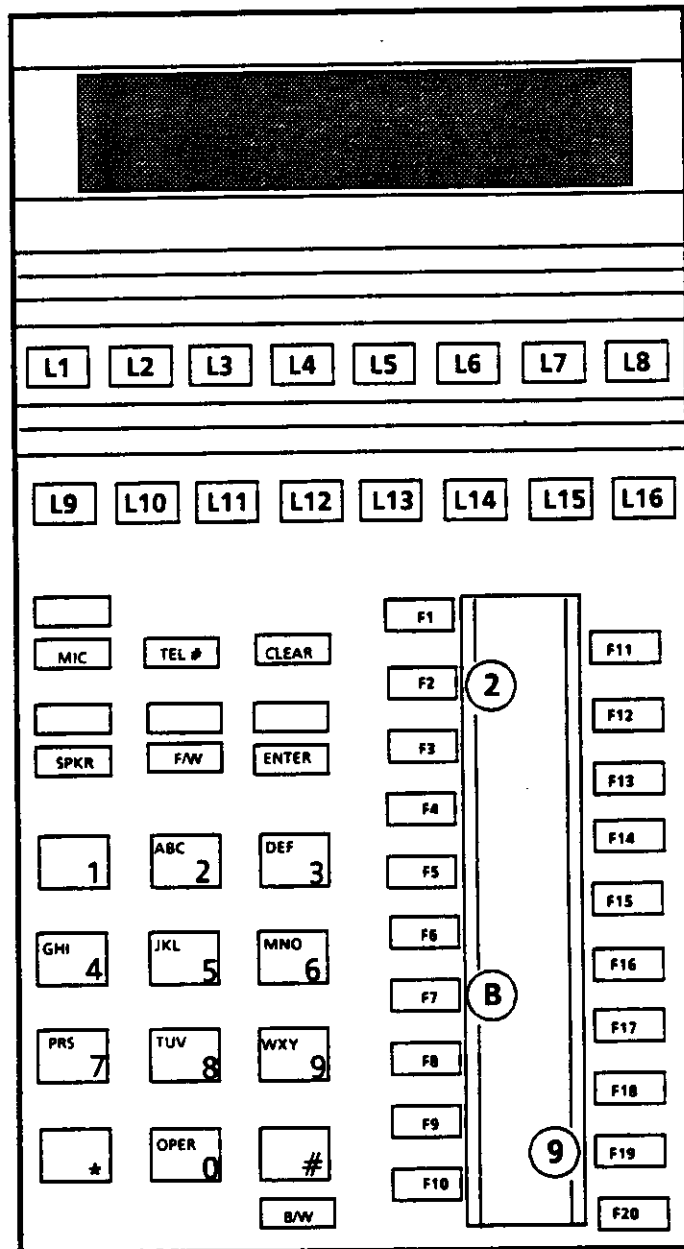

**GENERAL INFORMATION - LCR BYPASS ASSIGNMENT**

When dialing a station assigned for LCR, this area of the memory block is used to assign (system wide) whether or not Trunk Access Code Groups 2 thru 8 will bypass LCR. NOTE: Reorder tone is received by a station assigned for LCR when that station dials an access code not assigned to by-pass LCR.

**MEMORY BLOCK 2B10 - RECALL KEY OPERATION FOR TIE LINES**

OPERATION ← AND → DISPLAY

1. Go off line.

	O	F	F	-	L	I	N	E		(	X	.	X	X	)
	P	R	O	G	R	A	M		M	O	D	E			

2. Depress F2, then F7.

S	Y	S	.		F	E	A	T	U	R	E	2			

3. Depress F20.

	T	I	E		R	E	C	A	L	L		A	S	G	N

4. Set L1 (as required) to receive Tie Line dial tone or extension dial tone. (See Note 1).

LED off = Extension dial tone (Default)

LED on = Tie line dial tone

5. Depress ENTER key.

6. Depress the SPKR key to go back on line.

**KEY FUNCTION (OFF LINE)**

SPKR - ON/OFF Line
TEL # -
F/W -
CLEAR -
ENTER - Enter each assignment
B/W -

**GUIDE TO FEATURE PROGRAMMING**

MEMORY BLOCK BEING PROGRAMMED	MEMORY BLOCK THAT MUST BE PROGRAMMED	MEMORY BLOCK THAT MAY HAVE TO BE PROGRAMMED
<b>2B10</b>		4E1 ~ 4E10

CPU-EB2 or higher.  
 NOTE:

- Stations that access Tie lines via dial access are affected by extension dial tone. Direct access of Tie lines is not affected by extension dial tone.

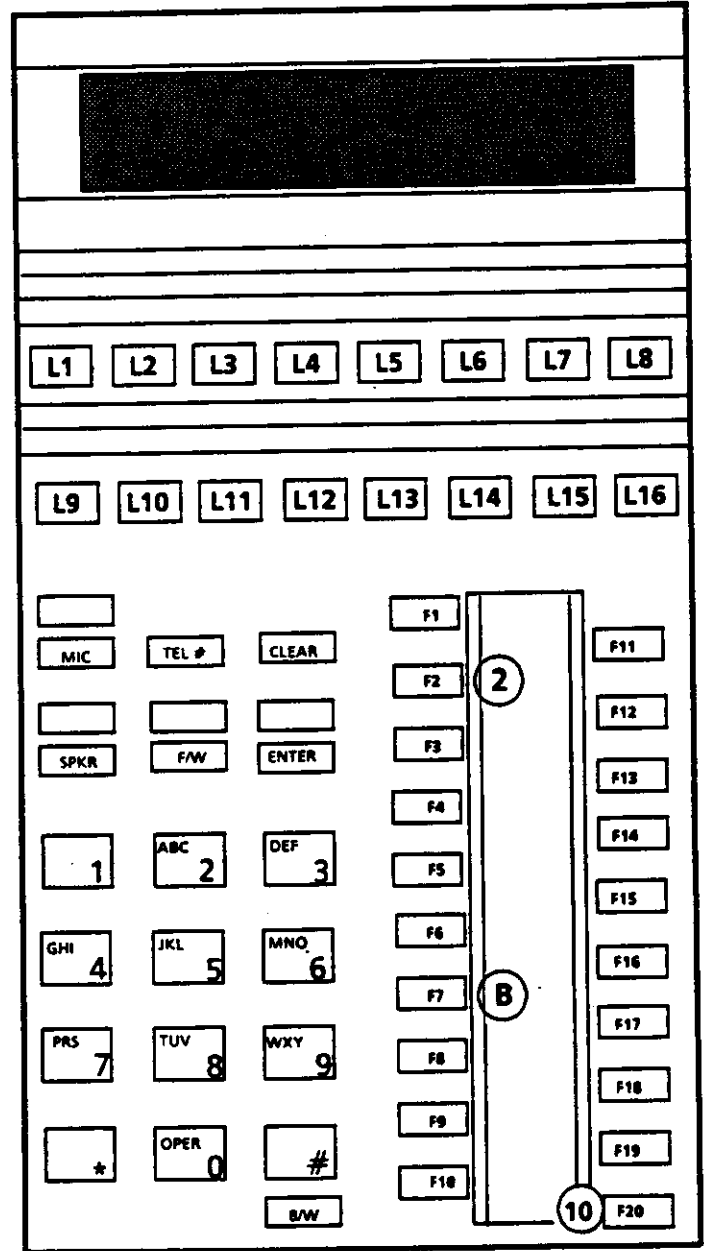

**GENERAL INFORMATION - RECALL KEY OPERATION FOR TIE LINES**

This area of the memory block is used to assign (system wide) the type of dial tone that will be returned when the RECALL key on a multibutton set is depressed while using a Tie Line. If DID trunks are in use, the system should be programmed for extension dial tone.

## MEMORY BLOCK 2C1 - TRUNK TO TRUNK GROUP ASSIGNMENT

OPERATION ← AND → DISPLAY

1. Go off line.

	O	F	F	-	L	I	N	E		(	X	.	X	X	)
	P	R	O	G	R	A	M		M	O	D	E			

2. Depress F2, then F8.

S	Y	S	.		G	R	O	U	P						

3. Depress F11.

	T	R	U	N	K	-	T	R	U	N	K	.	G		
T	R	U	N	K	?	?									

4. Dial the trunk number to be entered.  
 Example: 01 for Trunk 1. (See Note 1).

	T	R	U	N	K	-	T	R	U	N	K	.	G		
T	R	U	N	K	0	1	-	T	R	U	N	K	.	G	X

5. Dial the Trunk Group (1 ~ 8) the trunk is assigned to. Example: 4 for Trunk Group 4. (See Notes 2 & 4).

	T	R	U	N	K	-	T	R	U	N	K	.	G		
T	R	U	N	K	0	1	-	T	R	U	N	K	.	G	4

6. Depress ENTER key. (See Note 3).

	T	R	U	N	K	-	T	R	U	N	K	.	G		
T	R	U	N	K	0	2	-	T	R	U	N	K	.	G	X

7. For each subsequent trunk to be assigned, repeat steps 5 and 6, or depress TEL # key to assign a specific trunk.

8. Depress SPKR key to go back on line.

**KEY FUNCTION (OFF LINE)**

SPKR - ON/OFF Line
TEL # - Enter new trunk number
F/W - Increment trunk number
CLEAR -
ENTER - Enter each assignment
B/W - Decrement trunk number

**GUIDE TO FEATURE PROGRAMMING**

MEMORY BLOCK BEING PROGRAMMED	MEMORY BLOCK THAT MUST BE PROGRAMMED	MEMORY BLOCK THAT MAY HAVE TO BE PROGRAMMED
2C1		1D4, 1D5, 1D7,
		2C2, 2C3, 3C2

All CPU levels.  
**NOTES:**

1. During step 4 any current Trunk Group assignment for the trunk number entered is displayed.
2. When assigning trunks to Trunk Groups, program changes do not take affect until all trunks in the Trunk Group are idle or when a second initialization is performed.
3. Depressing the ENTER key will cause the display to increment the trunk number.
4. If trunks are connected in ascending numerical order, to prevent collisions, it is recommended that high numbered loop start trunks be assigned to unused low numbered Trunk Groups and low numbered loop start trunks be assigned to high numbered Trunk Groups.  
Example: A system with 40 loop start trunks should be programmed as follows:  
Trunk Group 1 → Trunks 36 ~ 40  
Trunk Group 8 → Trunks 1 ~ 5

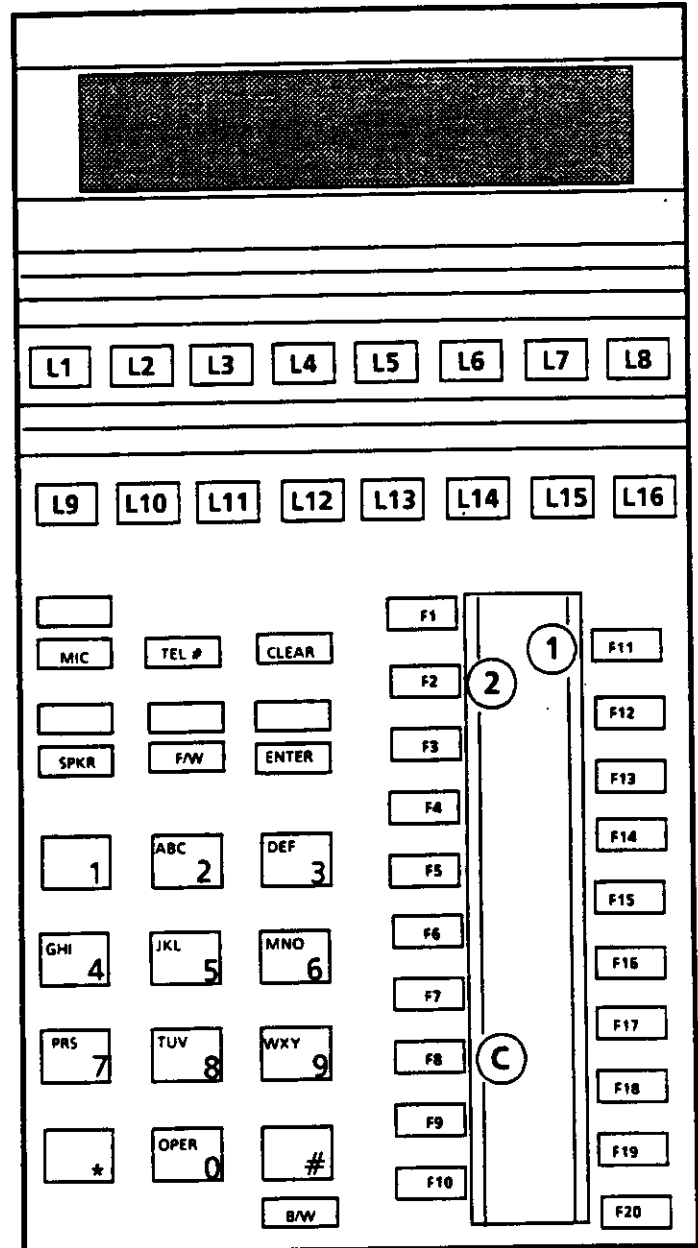

**GENERAL INFORMATION - TRUNK TO TRUNK GROUP ASSIGNMENT**

This area of the memory block is used to program individual trunks into Trunk Groups. This is necessary because system features such as trunk dial access and code restriction are based on Trunk Groups and not individual trunks.

MEMORY BLOCK 2C2 - TRUNK GROUP TO TENANT ASSIGNMENT

OPERATION ← AND → DISPLAY

1. Go off line.

	O	F	F	-	L	I	N	E		(	X	.	X	X	)
	P	R	O	G	R	A	M		M	O	D	E			

2. Depress F2, then F8.

S	Y	S	.		G	R	O	U	P						

3. Depress F12.

	T	R	U	N	K	.	G	-	T	E	N	A	N	T	
T	E	N	A	N	T	?									

4. Dial tenant number (1 ~ 3).  
 Example: Tenant 1. (See Note 1).

	T	R	U	N	K	.	G	-	T	E	N	A	N	T	
T	E	N	A	N	T	1									

5. Depress L1 to L8 to assign the appropriate Trunk Groups to the tenant chosen. (See Note 2).

6. Depress ENTER key. (See Note 3).

	T	R	U	N	K	.	G	-	T	E	N	A	N	T	
T	E	N	A	N	T	2									

7. Repeat steps 5 and 6 for all subsequent tenants, or depress TEL # key to program a specific tenant.

8. Depress the SPKR key to go back on line.

**KEY FUNCTION (OFF LINE)**

SPKR - ON/OFF Line
TEL # - Enters new tenant number
F/W - Increments tenant number
CLEAR -
ENTER - Enters each assignment
B/W - Decrements tenant number

**GUIDE TO FEATURE PROGRAMMING**

MEMORY BLOCK BEING PROGRAMMED	MEMORY BLOCK THAT MUST BE PROGRAMMED	MEMORY BLOCK THAT MAY HAVE TO BE PROGRAMMED
2C2	2C1	2A2, 2B3, 2C3, 3A4, 3C2

All CPU levels.

**NOTES:**

1. During step 4 any previous Trunk Group assignment for the tenant entered is shown by the LED pattern of L1 to L8.
2. In assigning the Trunk Groups to a specific tenant in step 5, the following procedure is used:  
 L1 to L8 correspond to Trunk Groups 1 to 8 respectively.  
 LED on: Assigned to tenant  
 LED off: Not assigned to tenant
3. Depression of the ENTER key will increment the display to the next tenant number.

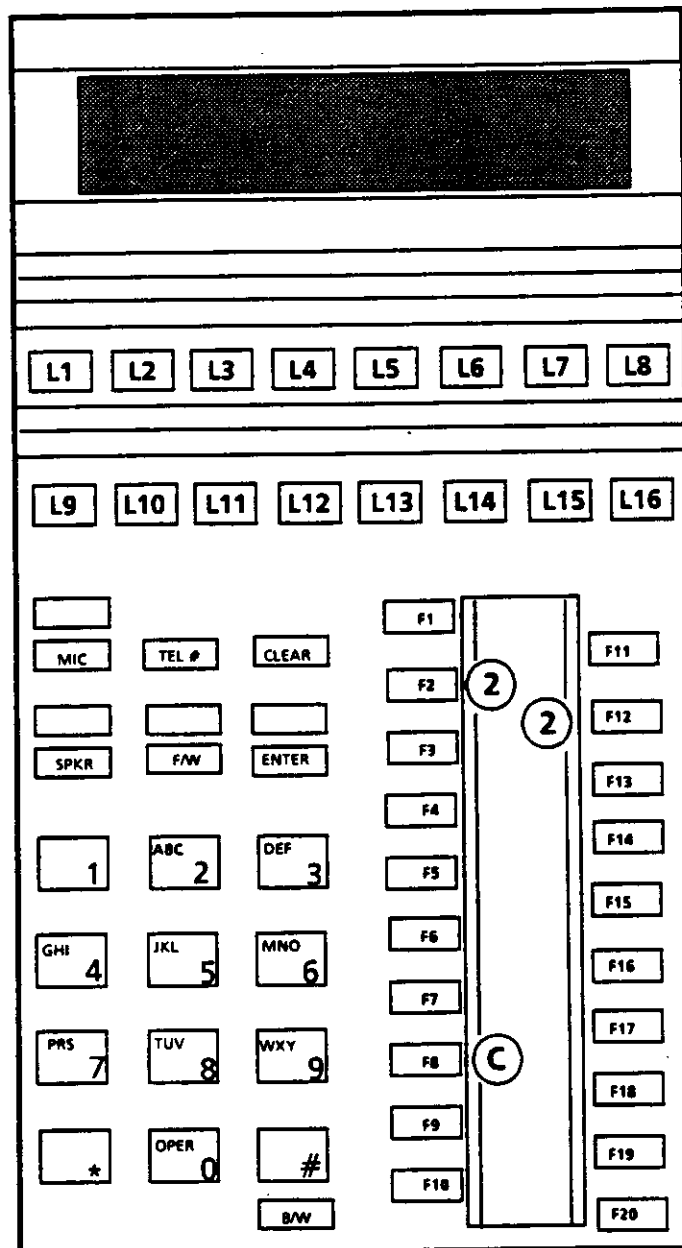

**GENERAL INFORMATION - TRUNK GROUP TO TENANT ASSIGNMENT**

This area of the memory block is used to assign up to eight system Trunk Groups to each of the tenants.

**MEMORY BLOCK 2C3 - TRUNK GROUP TO ACCESS CODE GROUP**

OPERATION ← AND → DISPLAY

1. Go off line.

O	F	F	-	L	I	N	E	(	X	.	X	X	)
P	R	O	G	R	A	M	M	O	D	E			

2. Depress F2, then F8.

S	Y	S	.		G	R	O	U	P				

3. Depress F13.

	T	R	K	.	G	-	A	.	C	.	G		
T	R	K	.	G	?								

4. Dial Trunk Group number (1 ~ 8).  
 Example: 4 for Trunk Group 4. (See Note 1).

	T	R	K	.	G	-	A	.	C	.	G		
T	R	K	.	G	4	-	A	.	C	.	G	X	

5. Dial access item code (A.C.G. 1 ~ 8) to be assigned to the Trunk Group chosen. Example: Dial 3 for item code (A.C.G.) number 3. (See Note 2).

	T	R	K	.	G	-	A	.	C	.	G		
T	R	K	.	G	4	-	A	.	C	.	G	3	

6. Depress ENTER key. (See Note 3).

	T	R	K	.	G	-	A	.	C	.	G		
T	R	K	.	G	5	-	A	.	C	.	G	X	

7. Repeat steps 5 and 6 for all subsequent Trunk Groups required, or depress TEL # key to assign a specific Trunk Group.

8. Depress the SPKR key to go back on line.



**KEY FUNCTION (OFF LINE)**

<b>SPKR</b> - ON/OFF Line
<b>TEL #</b> - Select a new Trunk Group
<b>F/W</b> - Increment Trunk Group
<b>CLEAR</b> - Clear access code group assignment
<b>ENTER</b> - Enter each assignment
<b>B/W</b> - Decrement Trunk Group number

**GUIDE TO FEATURE PROGRAMMING**

MEMORY BLOCK BEING PROGRAMMED	MEMORY BLOCK THAT MUST BE PROGRAMMED	MEMORY BLOCK THAT MAY HAVE TO BE PROGRAMMED
<b>2C3</b>	<b>2C1</b>	<b>2E1</b>

All CPU levels.

**NOTES:**

- During step 4 any current access code group assigned for the Trunk Group chosen is displayed.

**2. ACCESS ITEM CODE (A.C.G.)                      ACCESS DIAL CODE**

1	9 (Fixed)
2	8 (Default)
3	70 (Default)
4	71 (Default)
5	72 (Default)
6	73 (Default)
7	74 (Default)
8	75 (Default)

- Depressing the ENTER key will cause the display to increment to the next Trunk Group.

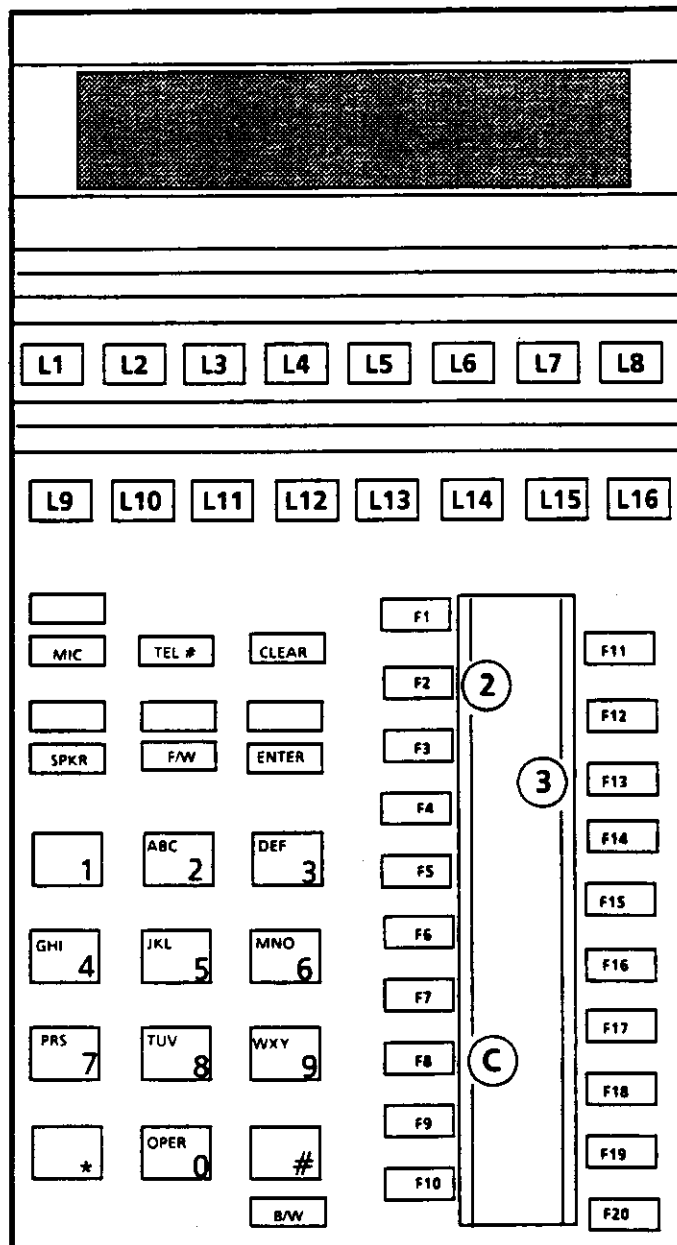

**GENERAL INFORMATION - TRUNK GROUP TO ACCESS CODE GROUP**

This area of the memory block is used to assign access item codes to the system's Trunk Groups. Access item code 1 cannot be changed, as indicated in note 2 above.

**MEMORY BLOCK 2C4 - VOICE MAIL HUNT GROUP ASSIGNMENT**

OPERATION ← AND → DISPLAY

1. Go off line.

	O	F	F	-	L	I	N	E		(	X	.	X	X	)
	P	R	O	G	R	A	M		M	O	D	E			

2. Depress F2, then F8.

S	Y	S	.		G	R	O	U	P						

3. Depress F14. (See Note 1).

	H	U	N	T		G	R	O	U	P					
T	E	L	?	?	?										

4. Enter VMI port extension number to be assigned to the Voice Mail Hunt Group.  
 Example: 147.

	H	U	N	T		G	R	O	U	P					
T	E	L	1	4	7										

5. Depress ENTER key. (See Note 2).

	H	U	N	T		G	R	O	U	P					
T	E	L	X	X	X										

6. Repeat steps 4 and 5 for all VMI ports to be assigned to the Voice Mail Hunt Group. (See Note 3).

7. Depress the SPKR key to go back on line.

**KEY FUNCTION (OFF LINE)**

SPKR - ON/OFF Line
TEL # -
F/W - Increments item number
CLEAR - Clears current assignment
ENTER - Enters each assignment
B/W - Decremens item number

**GUIDE TO FEATURE PROGRAMMING**

MEMORY BLOCK BEING PROGRAMMED	MEMORY BLOCK THAT MUST BE PROGRAMMED	MEMORY BLOCK THAT MAY HAVE TO BE PROGRAMMED
2C4		2B3, 2B4, 4C1

All CPU levels.

**NOTES:**

1. After step 3, the display will show any previous assignment.
2. Depressing the ENTER key causes the display to increment to the next extension number.
3. A maximum of 4 VMI port extension numbers can be programmed into the voice mail hunt group.

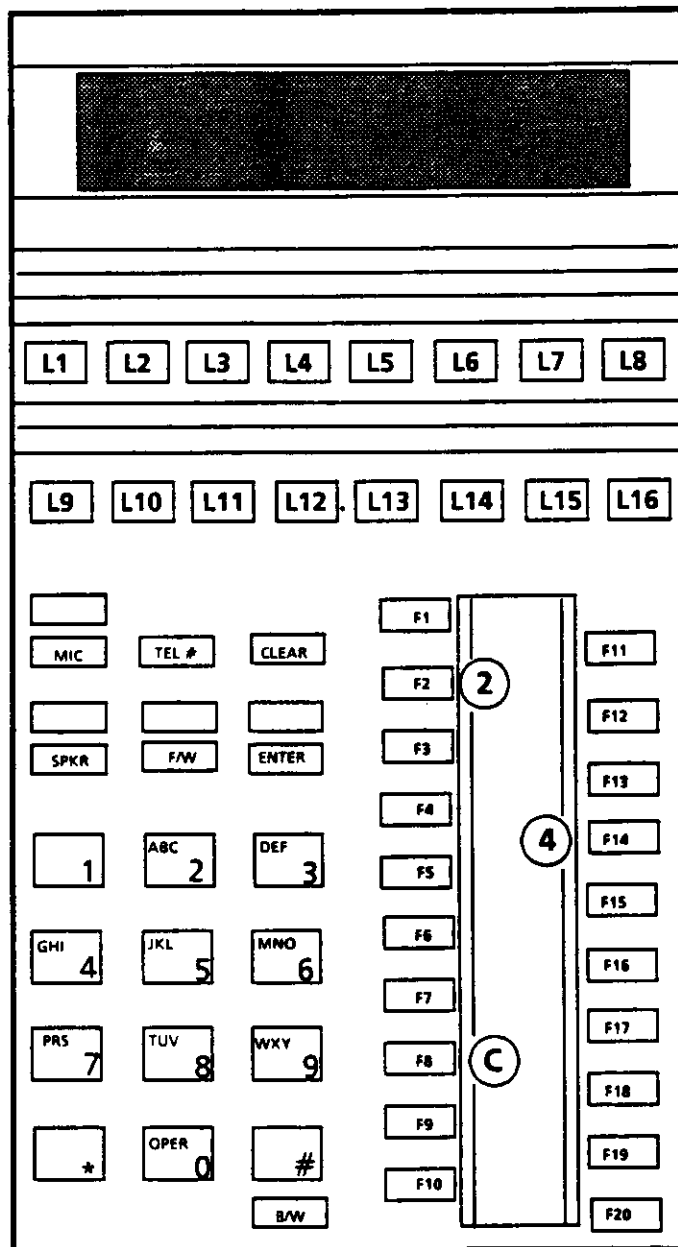

**GENERAL INFORMATION - VOICE MAIL HUNT GROUP ASSIGNMENT**

This area of the memory block is used to assign VMI port extension numbers to the Voice Mail Hunt Group. If no VMI-E ETU is installed, memory block 4C1 should be programmed BEFORE 2C4.

**MEMORY BLOCK 2C5 - DELAY ANNOUNCEMENT ASSIGNMENT**

OPERATION ← AND → DISPLAY

1. Go off line.

	O	F	F	-	L	I	N	E		(	X	.	X	X	)
	P	R	O	G	R	A	M			M	O	D	E		

2. Depress F2, then F8.

S	Y	S	.		G	R	O	U	P						

3. Depress F15.

	D	E	L	A	Y		A	N	N	O	U	N	C	E	
T	R	U	N	K	?	?									

4. Enter the trunk number to be assigned (01~40).  
 Example: Trunk 2.

	D	E	L	A	Y		A	N	N	O	U	N	C	E	
T	R	U	N	K	0	2									

5. Depress L1 as required to allow or disallow Delay Announcement.
6. Depress ENTER key (See Note 1).
7. Depress SPKR key to go back on line.

**KEY FUNCTION (OFF LINE)**

<b>SPKR</b> - ON/OFF Line
<b>TEL #</b> - Select trunk to be programmed
<b>F/W</b> - Increments item number
<b>CLEAR</b> -
<b>ENTER</b> - Enters each assignment
<b>B/W</b> - Decrements trunk number

**GUIDE TO FEATURE PROGRAMMING**

MEMORY BLOCK BEING PROGRAMMED	MEMORY BLOCK THAT MUST BE PROGRAMMED	MEMORY BLOCK THAT MAY HAVE TO BE PROGRAMMED
<b>2C5</b>	2C9	2D1, 2D2

CPU-EB3 or higher.  
**NOTES**

1. Depressing the ENTER key causes the display to increment to the next trunk number.

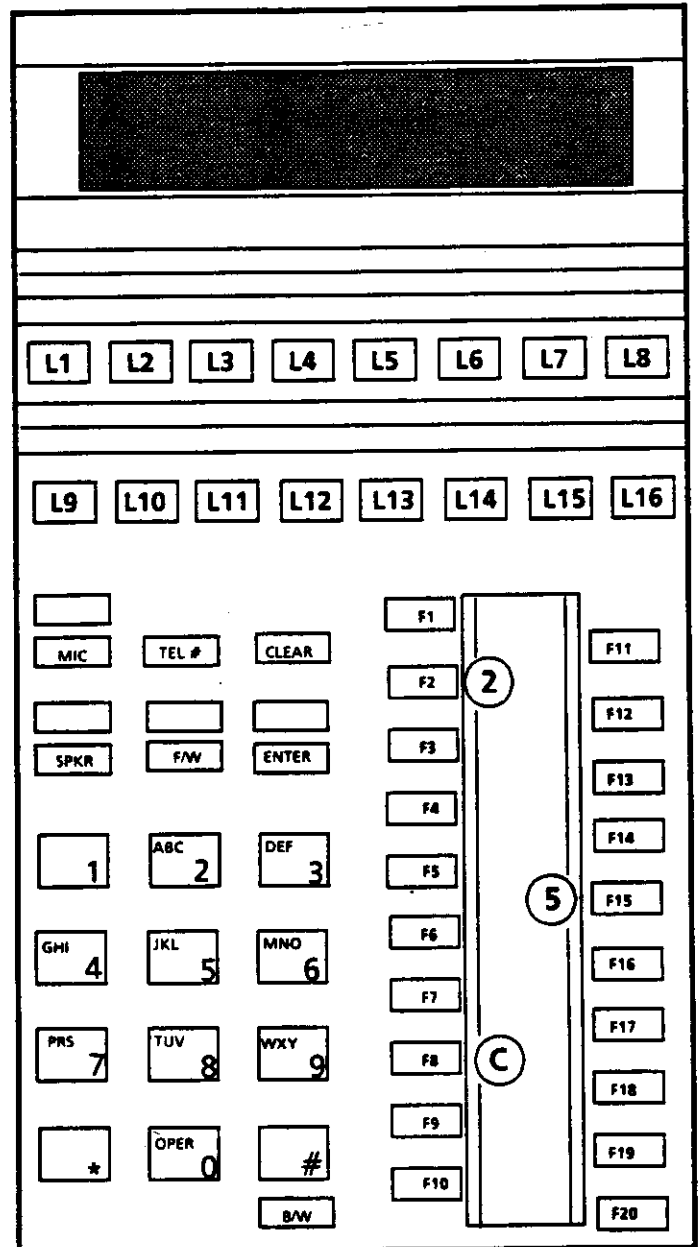

**GENERAL INFORMATION - DELAY ANNOUNCEMENT ASSIGNMENT**

This area of memory block is used to program the Delay Announcement feature for each desired trunk.

**MEMORY BLOCK 2C8 - UNIFORM DIAL TO TRUNK ACCESS CODE GROUP ASSIGNMENT**

OPERATION ← AND → DISPLAY

1. Go off line.

	O	F	F	-	L	I	N	E		(	X	.	X	X	)
	P	R	O	G	R	A	M			M	O	D	E		

2. Depress F2, then F8.

S	Y	S	.		G	R	O	U	P						

3. Depress F16.

U	.	D	.		-		T	R	K	.	A	.	C	.	G
U	.	D	.	?	?										

4. Enter the uniform dial item number to be assigned (01 ~ 20). Example: 02. (See Note 1).

U	.	D	.		-		T	R	K	.	A	.	C	.	G
U	.	D	.	0	2		-		A	.	C	.	G	X	

5. Enter Trunk Access Code Group Number to be assigned to Uniform Dial Number chosen (2 ~ 8). Example: Dial 4 for Trunk Access Code Group 4.

U	.	D	.		-		T	R	K	.	A	.	C	.	G
U	.	D	.	0	2		-		A	.	C	.	G	4	

6. Depress ENTER key. (See Note 2).

U	.	D	.		-		T	R	K	.	A	.	C	.	G
U	.	D	.	0	3		-		A	.	C	.	G	X	

7. Repeat Steps 4 and 5 to assign all Uniform Dial Numbers required, or depress TEL # to assign a specific Uniform Dial Number.

8. Depress SPKR key to go back on line.

**KEY FUNCTION (OFF LINE)**

<b>SPKR</b> - ON/OFF Line
<b>TEL #</b> - Selects Uniform Dial Number
<b>F/W</b> - Increments Uniform Dial Number
<b>CLEAR</b> - Clears previous assignment
<b>ENTER</b> - Enters each assignment
<b>B/W</b> - Decrements Uniform Dial Number

**GUIDE TO FEATURE PROGRAMMING**

MEMORY BLOCK BEING PROGRAMMED	MEMORY BLOCK THAT MUST BE PROGRAMMED	MEMORY BLOCK THAT MAY HAVE TO BE PROGRAMMED
<b>2C6</b>	2E1	2C1, 2C3 4E1 ~ 4E10

CPU-EB2 or higher.  
**NOTES:**

1. By default, Uniform Dial Numbers are assigned to Trunk Access Code Group 2.
2. Depressing the ENTER key causes the display to increment to the next Uniform Dial Item Number.

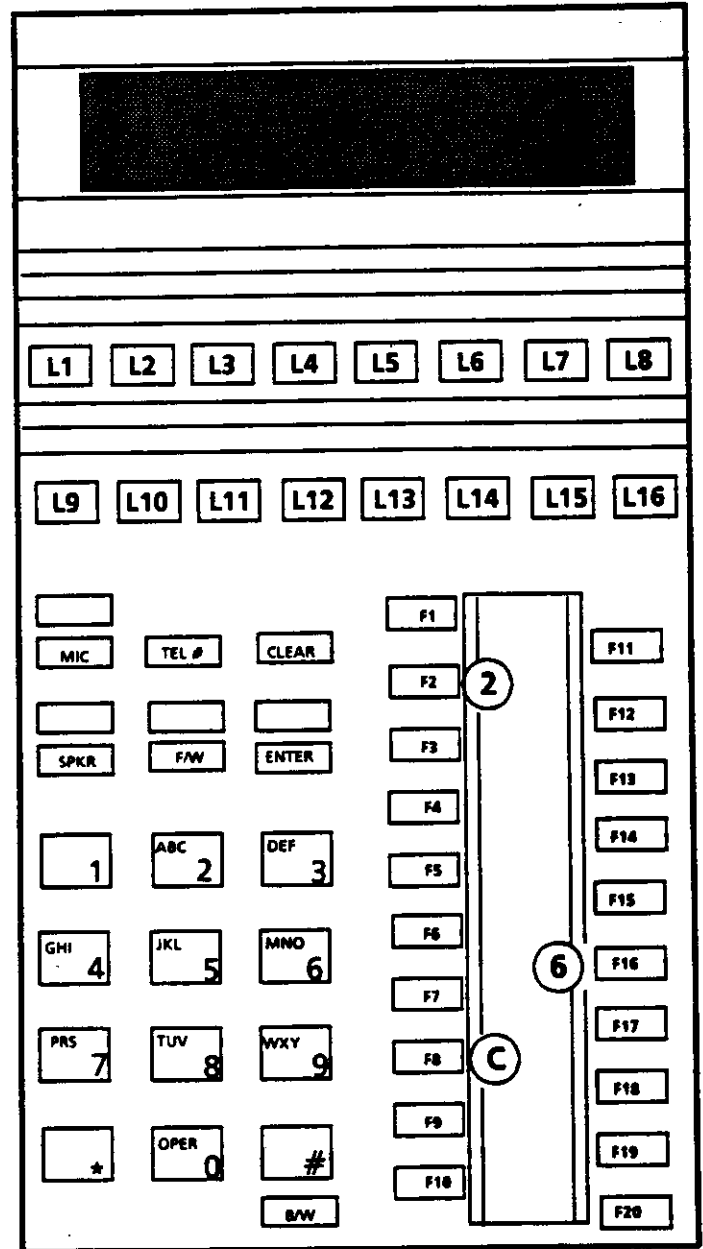

**GENERAL INFORMATION - UNIFORM DIAL TO TRUNK ACCESS CODE GROUP ASSIGNMENT**

This area of the memory block is used to assign Trunk Access Code Groups to the various Uniform Dial Numbers required. With Tie Line service, this assignment determines which trunks will be used when accessing uniform dialing.

**MEMORY BLOCK 2C7 - NIGHT CHIME ASSIGNMENT**

OPERATION ← AND → DISPLAY

1. Go off line.

	O	F	F	-	L	I	N	E		(	X	.	X	X	)
	P	R	O	G	R	A	M		M	O	D	E			

2. Depress F2, then F8.

S	Y	S	.		G	R	O	U	P						

3. Depress F17.

N	I	G	H	T		C	H	I	M	E					
N	O	.			?										

4. Dial the night chime number being assigned (1~3).  
 Example: Night Chime 1. (See Note 1).

N	I	G	H	T		C	H	I	M	E					1

5. Depress L1 to L8 to assign the appropriate Trunk Groups to the night chime selected. (See Note 2).

6. Depress ENTER key. (See Note 3).

N	I	G	H	T		C	H	I	M	E					2

7. Repeat steps 5 and 6 for all night chimes to be assigned.

8. Depress the SPKR key to go back on line.



**KEY FUNCTION (OFF LINE)**

<b>SPKR</b> - ON/OFF Line
<b>TEL #</b> - Enter new Night Chime number
<b>F/W</b> - Increment Night Chime number
<b>CLEAR</b> -
<b>ENTER</b> - Enters each assignment
<b>B/W</b> - Decrement Night Chime number

**GUIDE TO FEATURE PROGRAMMING**

MEMORY BLOCK BEING PROGRAMMED	MEMORY BLOCK THAT MUST BE PROGRAMMED	MEMORY BLOCK THAT MAY HAVE TO BE PROGRAMMED
<b>2C7</b>	2C1, 2C9	

All CPU levels.  
 NOTES:

- There are 3 Night Chimes (1 ~ 3) that are assigned to tenants (1 ~ 3).
- When assigning the Trunk Groups to the Night Chimes, line keys 1 ~ 8 correspond to Trunk Groups 1 ~ 8 respectively.
 

LED ON : Assigned to Night Chime  
 LED OFF : Not assigned to Night Chime
- Depressing the ENTER key will cause the display to increment to the next Night Chime.
- Trunk groups associated with DIT or DID trunks will not activate the external chime contacts.

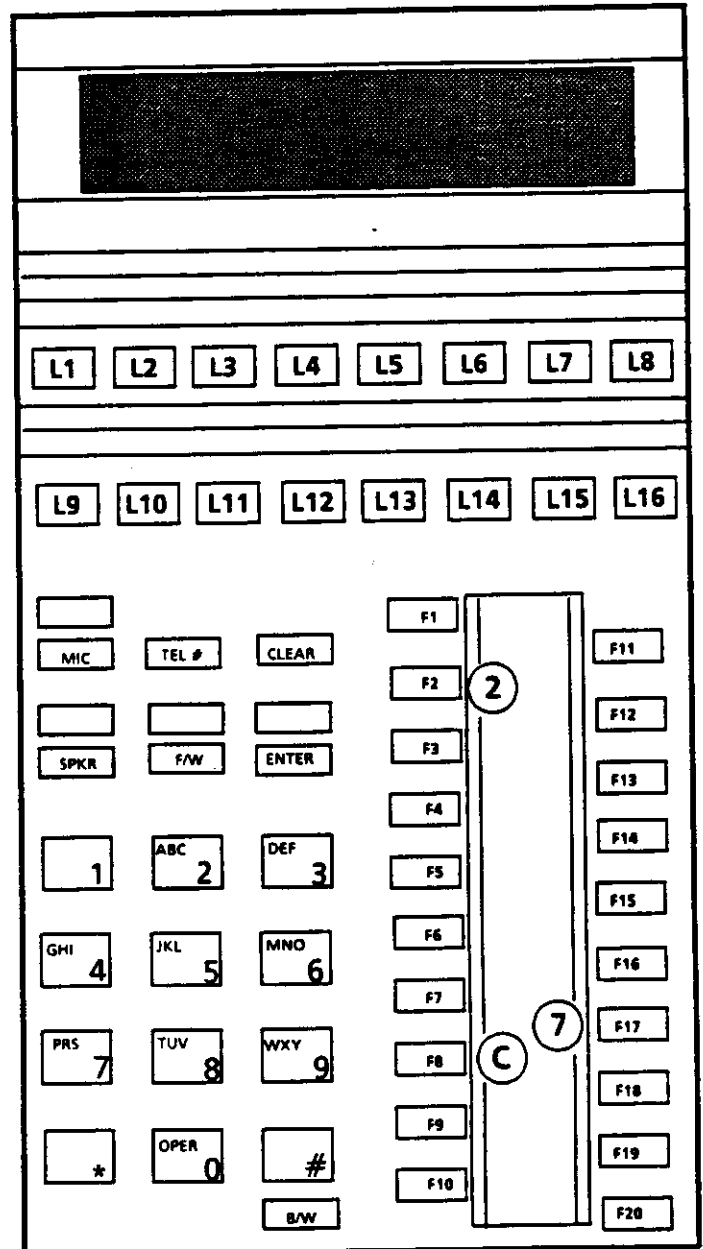

**GENERAL INFORMATION - NIGHT CHIME ASSIGNMENT**

This area of the memory block is used to assign the Trunk Groups to any or all of the 3 available Night Chime circuits to provide a relay contact closure to connect external common audible ringing, when the tenant is in night mode.

## MEMORY BLOCK 2C8 - EXTERNAL RINGING CONTROL ASSIGNMENT

OPERATION ← AND → DISPLAY

1. Go off line.
 

	O	F	F	.	L	I	N	E		(	X	.	X	X	)
	P	R	O	G	R	A	M		M	O	D	E			
  
2. Depress F2, then F8.
 

S	Y	S	.		G	R	O	U	P						
  
3. Depress F18.
 

E	X	T		R	I	N	G								
N	O	.			?										
  
4. Dial the number of the External Ringing Control circuit being assigned (1~4).  
 Example: Ext Ring 1. (See Note 1).
 

E	X	T		R	I	N	G								1
I	N	T	E	R	V	A	L	X							
  
5. Dial the number of the desired ringing interval (1~5) to be assigned to this External Ringing Control circuit. Example: Interval 2. (See Note 2).
 

E	X	T		R	I	N	G								1
I	N	T	E	R	V	A	L	2							
  
6. Depress L1 to L8 to assign the appropriate Trunk Groups to the External Ringing Control circuit selected. (See Note 3).
  
7. Depress ENTER key. (See Note 4).
 

E	X	T		R	I	N	G								2
I	N	T	E	R	V	A	L	2							
  
8. Repeat steps 5~ 7 for all subsequent External Ringing Controls to be assigned, or depress TEL # key to program a specific External Ringing Control circuit.
  
9. Depress the SPKR key to go back on line.

**KEY FUNCTION (OFF LINE)**

<b>SPKR - ON/OFF Line</b>
<b>TEL # - Enter new Ext. Ring Control circuit #</b>
<b>F/W - Increment Ext. Ring Control circuit #</b>
<b>CLEAR - Clears the interval assignment</b>
<b>ENTER - Enters each assignment</b>
<b>B/W - Decrement Ext. Ring Control circuit #</b>

**GUIDE TO FEATURE PROGRAMMING**

MEMORY BLOCK BEING PROGRAMMED	MEMORY BLOCK THAT MUST BE PROGRAMMED	MEMORY BLOCK THAT MAY HAVE TO BE PROGRAMMED
<b>2C8</b>	2C1, 2C9	

All CPU levels.

**NOTES:**

1. There are 4 External Ringing Control circuits (1~4) that any or all of the Trunk Groups (1~8) can be assigned to.
2. Each External Ringing Control circuit can be assigned one of five ringing intervals (1~5). During step 4, the previous interval assignment is displayed.

**INTERVAL NUMBER**

INTERVAL NUMBER	RINGING PATTERN
1	0.5 sec.ON / 0.5 sec. OFF
2	1 sec.ON / 1 sec. OFF
3	2 sec.ON / 2sec. OFF
4	0.5 sec.ON / 0.5 sec. OFF
5	0.5 sec.ON / 2.5 sec. OFF
	Continuous (Always ON)

3. When assigning Trunk Groups to the External Ringing Control circuits, L1~L8 correspond to Trunk Groups 1~8 respectively.

LED ON = Assigned  
LED OFF = Not assigned

4. Depressing the ENTER key will cause the display to increment to the next External Ring Control circuit.

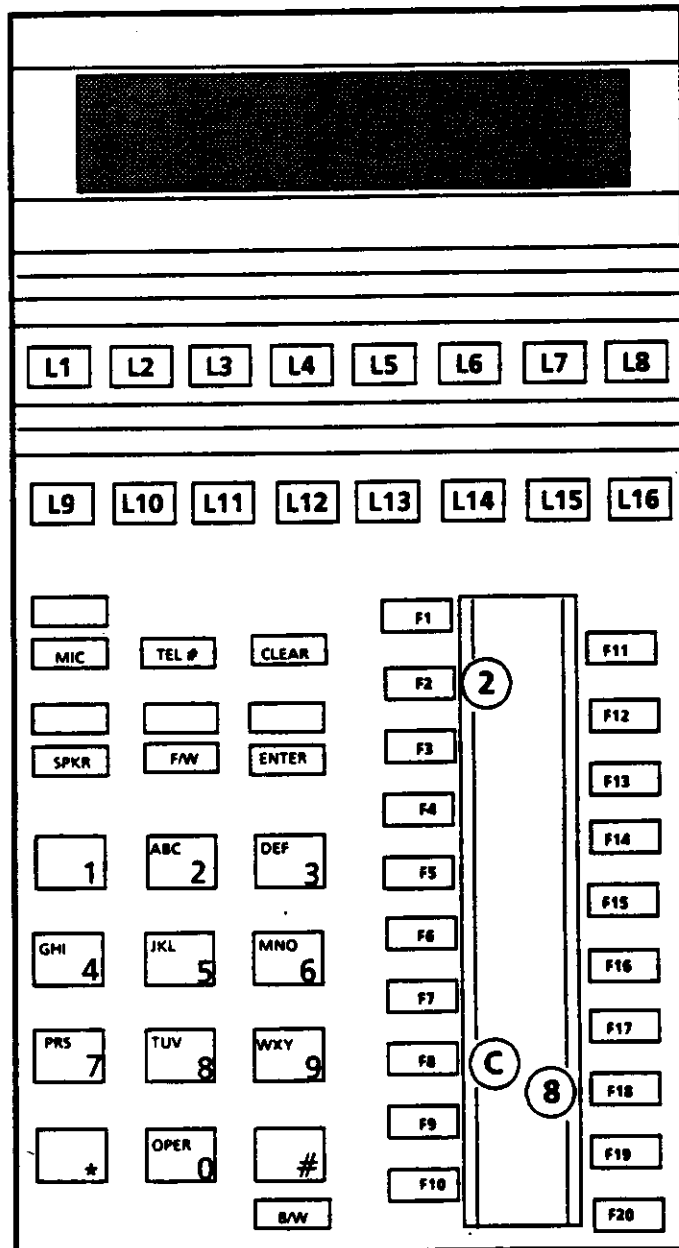

5. Trunk groups associated with DIT or DID trunks will not activate the external ring contacts.

**GENERAL INFORMATION - EXTERNAL RINGING CONTROL ASSIGNMENT**

This area of the memory block is used to assign Trunk Groups to any or all of the 4 available External Ring Control circuits and to assign each of these circuits distinctive ringing control/intervals (1 of 5 available patterns).

### MEMORY BLOCK 2C9 - ECR RELAY ASSIGNMENT

OPERATION ← AND → DISPLAY

1. Go off line.

O	F	F	-	L	I	N	E		(	X	.	X	X	)
P	R	O	G	R	A	M		M	O	D	E			

2. Depress F2, then F8.

S	Y	S	.		G	R	O	U	P					

3. Depress F19.

	R	E	L	A	Y		A	S	S	I	G	N	.	
R	E	L	A	Y	?	?								

4. Dial the number of the relay being assigned (04~10). Example: Relay 04. (See Note 1).

R	.		A	S	G	N		R	E	L	A	Y	0	4
			V	A	C	A	N	T						

5. Depress L1, L2, or L3 to assign the selected relay to Night Chime, External Ring or Delay Announcement respectively. Example: L1 (Night Chime). See Note 2.

R	.		A	S	G	N		R	E	L	A	Y	0	4
N	I	G	H	T		C	H	I	M	E		?		

6. Dial the number of the Night Chime (1~3) to be assigned to this relay. Example: Night Chime 2.

R	.		A	S	G	N		R	E	L	A	Y	0	4
N	I	G	H	T		C	H	I	M	E		2		

7. Depress ENTER key. (See Note 3).

R	.		A	S	G	N		R	E	L	A	Y	0	5
			V	A	C	A	N	T						

8. Repeat steps (5~7) for all subsequent relays to be assigned.
9. Depress SPKR key to go back on line.

**KEY FUNCTION (OFF LINE)**

<b>SPKR</b> - ON/OFF Line
<b>TEL #</b> - Enters new relay number
<b>F/W</b> - Increments relay number
<b>CLEAR</b> - Clears assignment (See Note 1)
<b>ENTER</b> - Enters each assignment
<b>B/W</b> - Decrements relay number

**GUIDE TO FEATURE PROGRAMMING**

MEMORY BLOCK BEING PROGRAMMED	MEMORY BLOCK THAT MUST BE PROGRAMMED	MEMORY BLOCK THAT MAY HAVE TO BE PROGRAMMED
<b>2C9</b>	<b>2C7, 2C8</b>	<b>2C5</b>

All CPU levels. (See Note 2.)

**NOTES:**

1. Although there are a total of 10 relays (1~ 10), relays 1~3 are permanently assigned to External Pagezones 1~3.

During step 4, any previously assigned function for the selected relay will appear. If there was no previous assignment, the display will show VACANT.

2. If L2 (External Ring) is depressed, a number from 1 to 4 has to be entered. If L3 (Delay Announce) is depressed, no additional digits are required, and you proceed with step 7. (CPU-EB3 or higher.)
3. Depressing the ENTER key will cause the display to increment to the next relay number.
4. Trunk groups associated with DIT or DID trunks will not activate the External Chime or External Ring contacts.

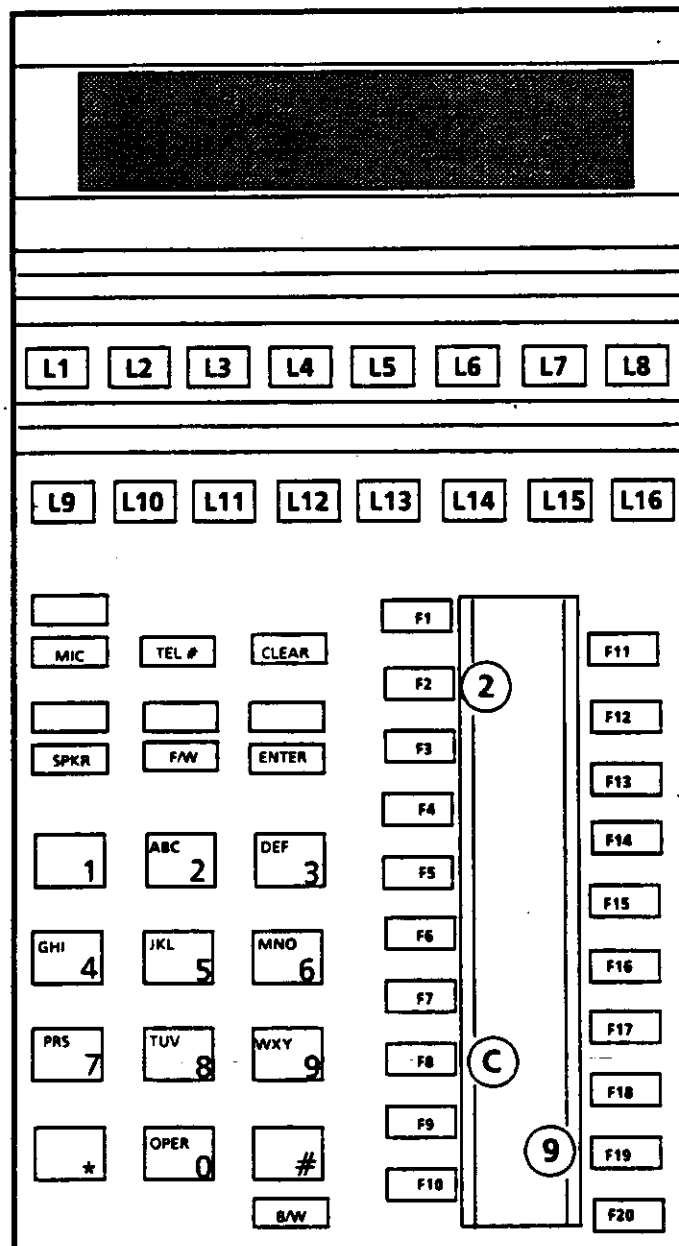

**GENERAL INFORMATION - ECR RELAY ASSIGNMENT**

This area of the memory block is used to assign either Night Chime (1~3), External Ringing Control (1~4) or Delay Announcement functions to control relays 4~10. Relays 1~3 have a fixed assignment to External Page zones 1~3.

**MEMORY BLOCK 2C10 - VIRTUAL EXTENSION ASSIGNMENT**

OPERATION ← AND → DISPLAY

1. Go off line.
 

	O	F	F	-	L	I	N	E		(	X	.	X	X	)	
	P	R	O	G	R	A	M		M	O	D	E				
  
2. Depress F2, then F8.
 

S	Y	S	.		G	R	O	U	P		A	S	E			
  
3. Depress F20.
 

	V	E		A	S	S	I	G	N							
V	E		?	?												
  
4. Dial number of VE (01 ~ 48) being assigned.  
 Example: VE 01. (See Note 1).
 

	V	E		A	S	S	I	G	N			V	E	0	1	
E	X	T	E	N	S	I	O	N	-	?	?	?				
  
5. Dial extension number to be assigned to the VE number chosen.  
 Example: Extension 200. (See Note 2).
 

	V	E		A	S	S	I	G	N			V	E	0	1	
E	X	T	E	N	S	I	O	N	-	2	0	0				
  
6. Depress ENTER key. (See Notes 3 & 4).
 

	V	E		A	S	S	I	G	N			V	E	0	2	
E	X	T	E	N	S	I	O	N	-	X	X	X				
  
7. Repeat steps 5 and 6 for all subsequent VE numbers to be assigned or go to step 3 to assign a specific Virtual Extension.
8. Depress the SPKR key to go back on line.

**KEY FUNCTION (OFF LINE)**

<b>SPKR</b> - ON/OFF Line
<b>TEL #</b> - Select a new VE
<b>F/W</b> - Increment VE
<b>CLEAR</b> - Clear extension number
<b>ENTER</b> - Enter each assignment
<b>B/W</b> - Decrement VE

**GUIDE TO FEATURE PROGRAMMING**

MEMORY BLOCK BEING PROGRAMMED	MEMORY BLOCK THAT MUST BE PROGRAMMED	MEMORY BLOCK THAT MAY HAVE TO BE PROGRAMMED
<b>2C10</b>		

All CPU levels.

**NOTES:**

1. During step 4 any previous extension number assigned to a VE number chosen is displayed. Total number of VE numbers is 48 regardless of the number of stations installed.
2. Extension number entered in step 5 cannot be already assigned to a port or to another VE number.
3. Depressing the ENTER key will cause the display to increment the VE number.
4. If a particular VE is busy, programming for that extension number cannot be done until the extension is idle.

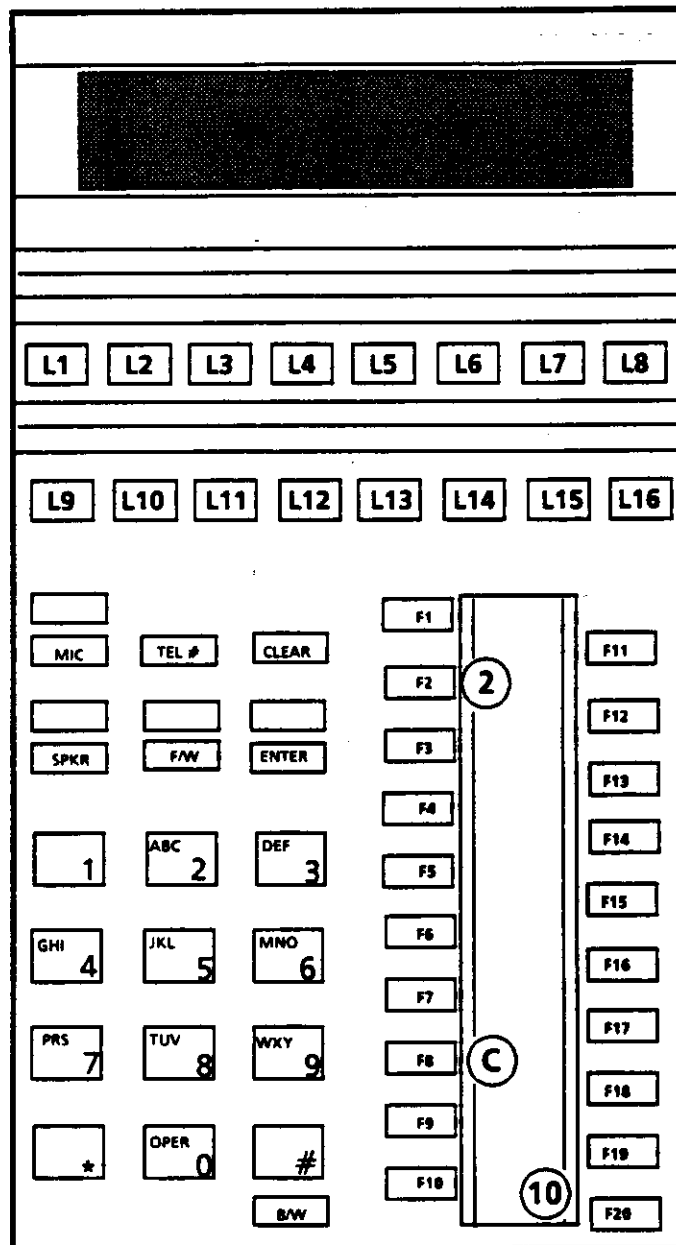

**GENERAL INFORMATION - VIRTUAL EXTENSION ASSIGNMENT**

This area of the memory block is used to assign Virtual Extension numbers. The total number of Virtual Extensions is 48, which are extensions 200~247 in system default.

**MEMORY BLOCK 2D1 - TIME BASE ASSIGNMENT I**

OPERATION ← AND → DISPLAY

1. Go off line.
 

	O	F	F	-	L	I	N	E		(	X	.	X	X	)	
	P	R	O	G	R	A	M		M	O	D	E				
  
2. Depress F2, then F9.
 

S	Y	S	.		T	I	M	E		B	A	S	E			
  
3. Depress F11.
 

T	I	M	E		B	A	S	E		1	0	S	E	C		
D	E	P	R	E	S	S		L	I	N	E		K	E	Y	
  
4. Depress line key associated with the item to be changed (associated LED lights).  
 Example : LK 8 - Call Forward No Answer.  
 (See Note 1).
 

T	I	M	E		B	A	S	E		1	0	S	E	C	
F	W	D		N	O		A	N	S			-	X	X	
  
5. Dial count value to be entered (01~99).  
 Example: Time Count 02, for a total of 20 seconds. (See Note 3).
 

T	I	M	E		B	A	S	E		1	0	S	E	C	
F	W	D		N	O		A	N	S			-	0	2	
  
6. Depress ENTER key. (See Note 2).
 

T	I	M	E		B	A	S	E		1	0	S	E	C		
E	X	H	O	L	D		R	E	C	A	L	L	-	X	X	
  
7. Repeat steps 5 and 6 for all items required.
  
8. Depress the SPKR key to go back on line.



**KEY FUNCTION (OFF LINE)**

SPKR - ON/OFF Line
TEL # - Selects line key
F/W - Increment to next timer
CLEAR -
ENTER - Enters each timer count
B/W - Decrements to previous timer

**GUIDE TO FEATURE PROGRAMMING**

MEMORY BLOCK BEING PROGRAMMED	MEMORY BLOCK THAT MUST BE PROGRAMMED	MEMORY BLOCK THAT MAY HAVE TO BE PROGRAMMED
2D1		

All CPU levels. (See Note 1.)

**NOTES:**

1. During step 4 the display shows the current count of the timer chosen.

LINE	KEY TIMER	DEFAULT
L1	Call Park Recall	3 min.
L3	Delay Announce Auto Release (CPU-EB3 or higher)	10 min.
L4	Start time (SMDR)	20 sec.
L5	DSS/BLF camp-on recall (Att. recall)	50sec.
L6	Non Ex-Hold/Transfer (Camp-On) recall	50 sec.
L7	Auto callback/Trunk Queuing cancel	20 sec.
L8	Call forward/no answer	20 sec.
L9	Exclusive hold recall	1 min.
L10	External page access	5 min.
L11	Internal page access	1 min.
L13	Valid call timer (SMDR)	40 sec.
L14	Modem Reserve Timer (CPU-EB2)	10 min.
L15	Conference Park recall (CPU-EB3)	5 min.

2. Depressing the ENTER key causes the programming to move to the next item associated with the next line key.

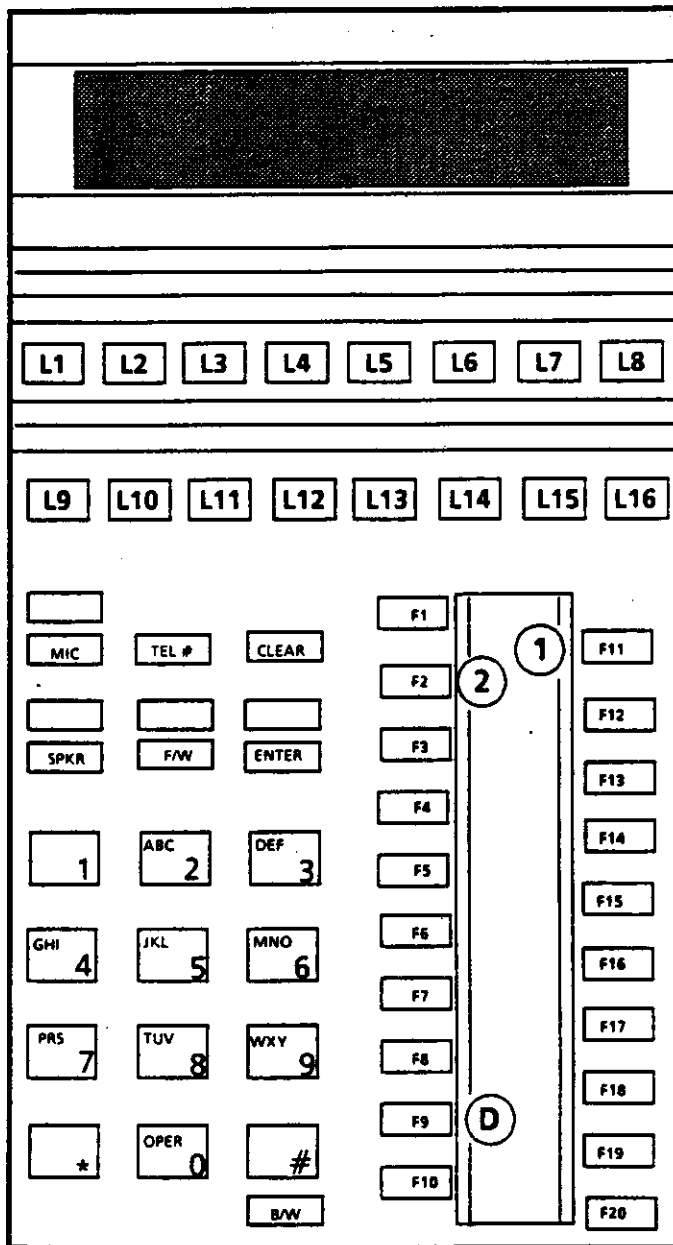

3. Time out = time base (10 seconds) X count (01 ~ 99).

**GENERAL INFORMATION - TIME BASE ASSIGNMENT I**

This area of the memory block is used to assign time out counts to various system base timers. Refer to Section 350 for explanation of each timer.

BASE x COUNT = VALUE

**MEMORY BLOCK 2D2 - TIME BASE ASSIGNMENT II**

OPERATION ← AND → DISPLAY

1. Go off line.

O	F	F	-	L	I	N	E		(	X	.	X	X	)
P	R	O	G	R	A	M		M	O	D	E			

2. Depress F2, then F9.

S	Y	S	.		T	I	M	E		B	A	S	E	

3. Depress F12.

T	I	M	E		B	A	S	E		1	S	E	C	
D	E	P	R	E	S		L	I	N	E		K	E	Y

4. Depress line key associated with the item to be changed. Example: LK1 - MFR Time Out. LK1 LED lights. (See Note 1).

T	I	M	E		B	A	S	E		1	S	E	C		
M	F	R		T	I	M	E		O	U	T		-	X	X

5. Dial count value to be entered (01 ~ 99).  
 Example: Time Count 10 for a total of 10 seconds (See Note 3).

T	I	M	E		B	A	S	E		1	S	E	C		
M	F	R		T	I	M	E		O	U	T		-	1	0

6. Depress ENTER key. (See Note 2).

T	I	M	E		B	A	S	E		1	S	E	C		
T	A	L	K		S	T	A	R	T				-	X	X

7. Repeat steps 5 and 6 for all items required.

8. Depress the SPKR key to go back on line.

**KEY FUNCTION (OFF LINE)**

<b>SPKR</b> - ON/OFF Line
<b>TEL #</b> - Select line key
<b>F/W</b> - Toggles between the two timers
<b>CLEAR</b> -
<b>ENTER</b> - Enter each timer count value
<b>B/W</b> - Toggles between the two timers

**GUIDE TO FEATURE PROGRAMMING**

MEMORY BLOCK BEING PROGRAMMED	MEMORY BLOCK THAT MUST BE PROGRAMMED	MEMORY BLOCK THAT MAY HAVE TO BE PROGRAMMED
<b>2D2</b>		

All CPU levels. (See Note 1.)

**NOTES:**

1. During step 4 the display shows the current count of the timer chosen.

LINE KEY	TIMER	DEFAULT
L1	MFR Timeout	10 sec.
L2	Talk Start Timer	18 sec.
L3	Delayed Ringing (CO line) (CPU-EB3)	15 sec.
L4	Delayed Ringing (Extension) (CPU-EB3)	10 sec.
L5	Voice Mail Automatic Dial Send Start (CPU-EB3)	2 sec.
L6	Delay Announce Start (CPU-EB3)	20sec.

2. Depressing the ENTER key causes the programming to move to the next item associated with the next line key.

3. Time Out = Time Base (1 sec.) X count (01~99).

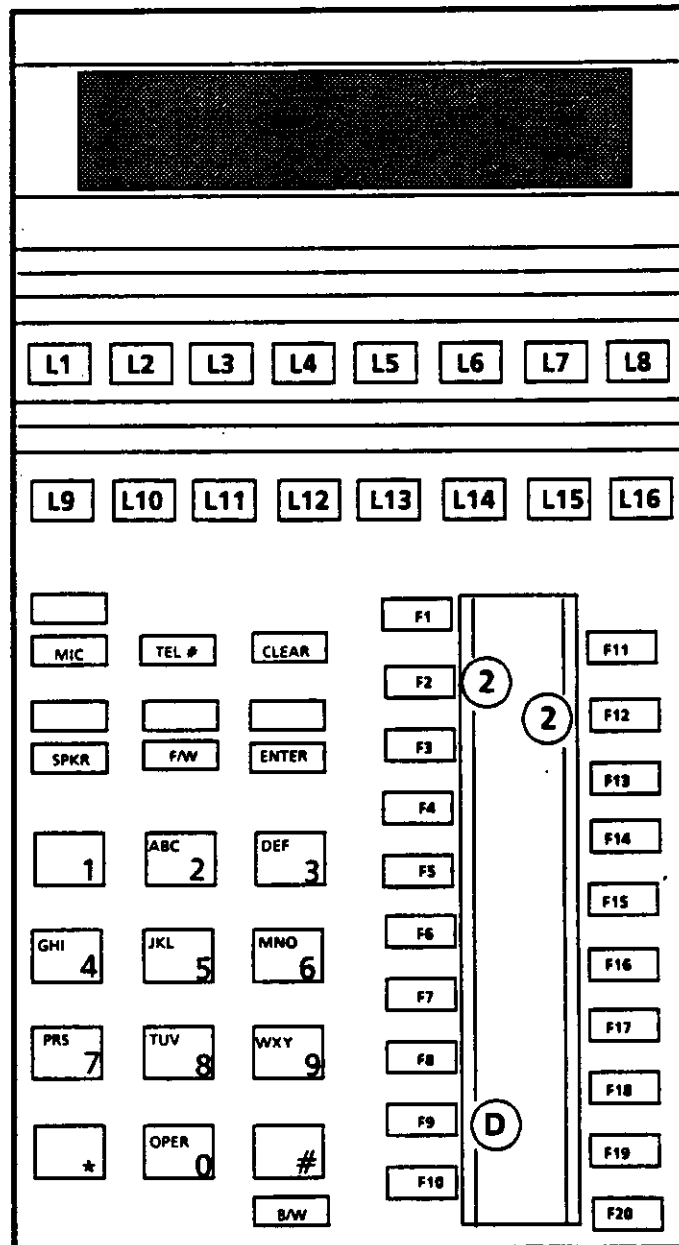

**GENERAL INFORMATION - TIME BASE ASSIGNMENT II**

This area of the memory block is used to assign time out counts to MFR and Talk Start base timers. Refer to Section 350 for explanation of each timer.

**BASE x COUNT = VALUE**

**MEMORY BLOCK 2D3 - TIME BASE ASSIGNMENT III**

OPERATION ← AND → DISPLAY

1. Go off line.

	O	F	F	-	L	I	N	E		(	X	.	X	X	)
	P	R	O	G	R	A	M		M	O	D	E			

2. Depress F2, then F9.

S	Y	S	.		T	I	M	E		B	A	S	E		

3. Depress F13.

T	I	M	E		B	A	S	E		1	0	M	I	N	
D	E	P	R	E	S		L	I	N	E		K	E	Y	

4. Depress line key LK1 - Automatic Disconnect Timer. LK 1 LED lights. (See Note 1).

T	I	M	E		B	A	S	E		1	0	M	I	N	
A	U	T	O	.	D	I	S	C	O	N	.		-	0	6

5. Dial count value to be entered (01 ~ 99).  
 Example: Time Count 04 for a total of 40 minutes. (See Note 2).

T	I	M	E		B	A	S	E		1	0	M	I	N	
A	U	T	O	.	D	I	S	C	O	N	.		-	0	4

6. Depress ENTER key.

7. Depress the SPKR key to go back on line.

**KEY FUNCTION (OFF LINE)**

SPKR - ON/OFF Line
TEL # - Selects line key
F/W -
CLEAR -
ENTER - Enters timer count value
B/W -

**GUIDE TO FEATURE PROGRAMMING**

MEMORY BLOCK BEING PROGRAMMED	MEMORY BLOCK THAT MUST BE PROGRAMMED	MEMORY BLOCK THAT MAY HAVE TO BE PROGRAMMED
2D3		

CPU-EB-2 or higher level.

**NOTES:**

1. During step 4 the display shows the current time count.

LINE KEY	TIMER	DEFAULT
L1	Automatic Disconnect	60 min.

2. Time Out = Time Base (10 min.) x count (01~99)

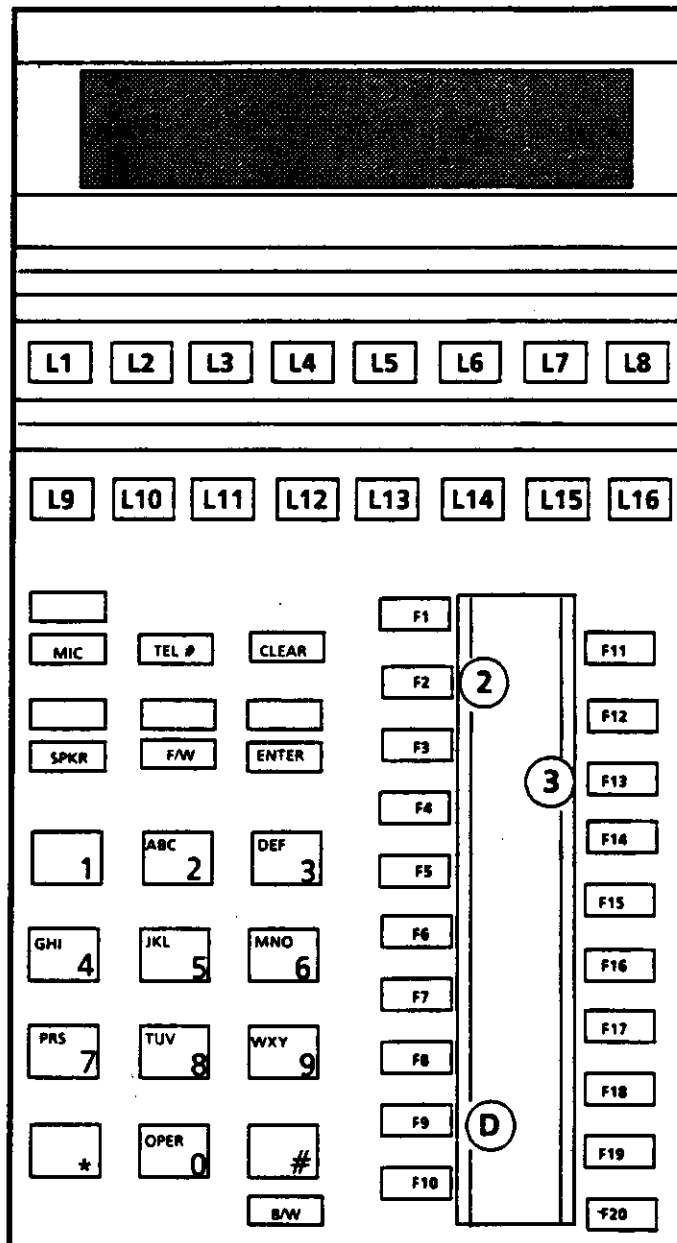

**GENERAL INFORMATION - TIME BASE ASSIGNMENT III**

This area of the memory block is used to assign the time out count for Trunk to Trunk Transfer Automatic Disconnect. Refer to Section 350 for an explanation.

**BASE x COUNT = VALUE**

**MEMORY BLOCK 2E1 - SYSTEM ACCESS CODE ASSIGNMENT**

OPERATION ← AND → DISPLAY

1. Go off line.
 

	O	F	F	-	L	I	N	E		(	X	.	X	X	)
	P	R	O	G	R	A	M		M	O	D	E			
  
2. Depress F2, then F10.
 

S	Y	S	.		A	C	C	E	S	S		C	O	D	E
  
3. Depress F11. See System Feature (Access) Code List of this section.
 

A	C	C	E	S	S		C	O	D	E					
I	T	E	M		N	U	M	B	E	R	?	?			
  
4. Dial the number of the item to be set.  
 Example: Item 23. (See Note 1).
 

A	C	C	E	S	S	.	C			I	T	E	M	2	3	
I	N	T	E	R	N	A	L			P	A	G	E	-	X	X
  
5. Dial new access code, or depress CLEAR key for VACANT.  
 Example: Access code 55. (See Note 2).
 

A	C	C	E	S	S	.	C			I	T	E	M	2	3	
I	N	T	E	R	N	A	L			P	A	G	E	-	5	5
  
6. Depress ENTER key. (See Note 3).
 

A	C	C	E	S	S	.	C			I	T	E	M	2	4	
E	X	T	E	R	N	A	L			P	A	G	E	-	X	X
  
7. Repeat steps 5 and 6 for all subsequent items required, or depress TEL # key to assign a specific item.
  
8. Depress the SPKR key to go back on line.

**KEY FUNCTION (OFF LINE)**

SPKR - ON/OFF Line
TEL # - Allows item number selection
F/W - Increment item number
CLEAR - Clear access code
ENTER - Enter each assignment
B/W - Decrement item number

**GUIDE TO FEATURE PROGRAMMING**

MEMORY BLOCK BEING PROGRAMMED	MEMORY BLOCK THAT MUST BE PROGRAMMED	MEMORY BLOCK THAT MAY HAVE TO BE PROGRAMMED
2E1		

All CPU levels. (See Code List on next page.)  
**NOTES:**

1. During step 4 the display shows the previous Access Code assigned to the item chosen.
2. The Access Code entered in step 5 cannot already be assigned to another Access Code number or be associated with the Station Numbering Plan.
3. Depressing the ENTER key causes the display to increment to the next item number.

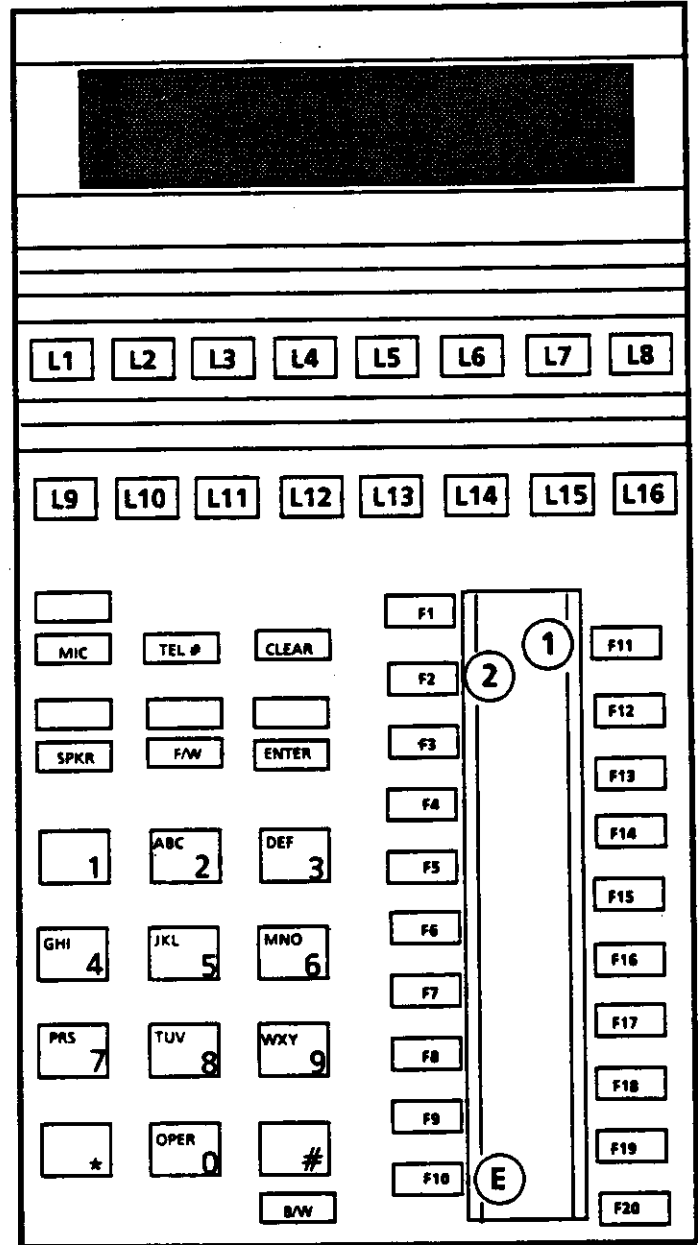

**GENERAL INFORMATION - SYSTEM ACCESS CODE ASSIGNMENT**

This area of the memory block is used to reassign the feature Access Codes of the System. For a list of the Access Codes, refer to the page immediately following.

## SYSTEM FEATURE (ACCESS) CODE LIST

**FLEXIBLE CODES:**

ITEM	FEATURE	DEFAULT
03	BGM over station speaker	49
04	Call Forward All/Originator	41
05	Call Forward All/Destination	47
06	Call Forward All/Attendant	44
07	Call Forward Busy No Answer/Originator	42
08	Call Forward Busy No Answer/Destination	48
09	Call Forward Busy No Answer/Attendant	45
13	Call Park	4*
14	Call Pickup/Directed	6#
15	Call Pickup/Group	6*
17	Ex-Hold, SLT	4#
23	Internal All Call (Non tenant)	55
	Internal Call Zone 1 (Non tenant)	
	Internal Call Zone 2 (Non tenant)	
	Internal Call Zone 3 (Non tenant)	
	Internal Meet-Me Answer (Non tenant)	
24	External Call Zone 1 (Non tenant)	56
	External Call Zone 2 (Non tenant)	
	External Call Zone 3 (Non tenant)	
	External All Zone (Non tenant)	
	External Meet-Me Answer (Non tenant)	
26	Night Call Pickup	60
27	Night Mode	68
29	Station Speed Dial Program for SLT	58
30	Station Lockout	61
31	Station Lockout Cancel from Attendant (CPU-EB or higher)	62
32	Special Code Program Change (Station Lockout)	59
34	Trunk and MFR Select/Test	67
35	Trunk and MFR Busy Out/Restore	57
36	Extension Number	1
37	Extension Number	2
38	Extension Number	3



39	Trunk Access Code 2	8
40	Trunk Access Code 3	70
41	Trunk Access Code 4	71
42	Trunk Access Code 5	72
43	Trunk Access Code 6	73
44	Trunk Access Code 7	74
45	Trunk Access Code 8	75
46	Automatic Call Back/Trunk Queue	* 1
47	Callback Request Message	#
50	Tone Override/Attendant Override	* 0
60 - 79	Uniform Dial (CPU-EB2 or higher)	Not Assigned
90	Voice Mail Hunt	63
91	Voice Mail Message Waiting	54
92	Hookflash to CO (SLT only) (CPU-EB2 or higher)	Not Assigned
93	CO Release (SLT only) (CPU-EB2 or higher)	Not Assigned
94	Account Code-Forced/Verified (CPU-EB3 or higher)	Not Assigned

**FIXED CODES:**

Attendant Call	0
Trunk Access Code 1	9
Last Number Redial	*
Off-Line for System Programming	# * 0
Speed Dial (Station)	# 00 ~ #19
Speed Dial (System)	# 20 ~ #99
Internal Voice/Ring Signaling	1
Callback Request/Message Retrieve	1
Account Code Entry	# #
Callback Request Message/Cancel	*

**MEMORY BLOCK 3A2 - ATTENDANT 3rd AND 4th ASSIGNMENT**

OPERATION ← AND → DISPLAY

1. Go off line.

	O	F	F	-	L	I	N	E		(	X	.	X	X	)
	P	R	O	G	R	A	M		M	O	D	E			

2. Depress F3.

S	Y	S	T	E	M		2								

3. Depress F6.

S	Y	S	.		A	T	T	E	N	D	A	N	T		

4. Depress F12. (See Note 1).

A	T	T	3		&		A	T	4		A	S	G	N	
D	E	P	R	E	S	S		L	I	N	E		K	E	Y

5. Depress L3 and/or L4 to assign or eliminate the 3rd. and/or 4th. Attendant, as needed.

6. Depress ENTER key.

7. Depress SPKR key to go back on line.

**KEY FUNCTION (OFF LINE)**

SPKR - ON/OFF Line
TEL # -
F/W -
CLEAR -
ENTER - Enters attendant assignment
B/W -

**GUIDE TO FEATURE PROGRAMMING**

MEMORY BLOCK BEING PROGRAMMED	MEMORY BLOCK THAT MUST BE PROGRAMMED	MEMORY BLOCK THAT MAY HAVE TO BE PROGRAMMED
3A2	1D8	3A3, 3A4,
		1C1

All CPU levels.

**NOTES:**

1. During step 3, L3 and L4 display any previous attendant assignment.

L3 LED ON = Third Attendant assigned  
 OFF = Third Attendant not assigned

L4 LED ON = Fourth Attendant assigned  
 OFF = Fourth Attendant not assigned

(L1 and L2 LEDs show ON to indicate attendants 1 and 2 are assigned.)

2. When assigned, these attendants are automatically assigned to TENANT 1.
3. 3rd and 4th Attendant positions can not be removed when:
  - Any stations are assigned to it for dial 0 (1D8).
  - When any DSS/BLF console is assigned to it (1C1).
4. 3rd and 4th Attendant Assignments must be assigned on the first ESI ETU, (ports 3 and 4 respectively).

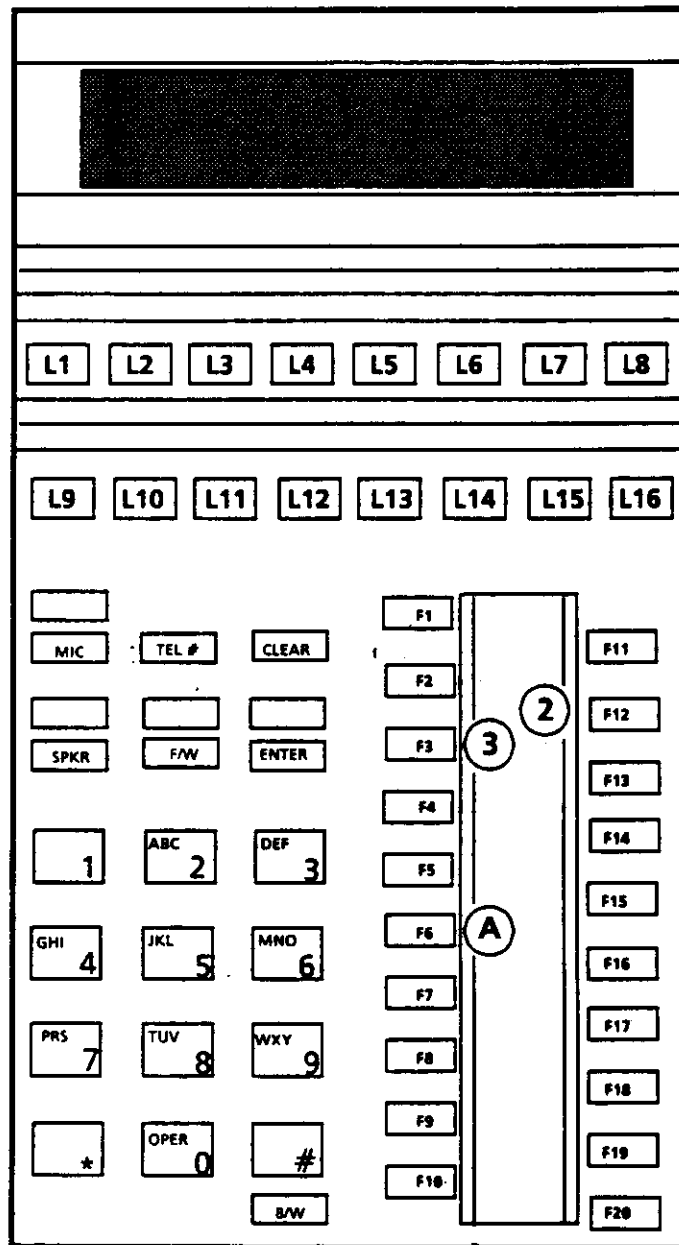

**GENERAL INFORMATION - ATTENDANT 3rd & 4th ASSIGNMENT**

This area of the memory block is used to allow a 3rd and 4th Attendant to be assigned to the system. An ATTENDANT Multiline Terminal must be an ETE-16D- ( ).

### MEMORY BLOCK 3A3 - ATTENDANT OVERFLOW ASSIGNMENT

OPERATION ← AND → DISPLAY

1. Go off line.

O	F	F	.	L	I	N	E		(	X	.	X	X	)
P	R	O	G	R	A	M		M	O	D	E			

2. Depress F3, then F6.

S	Y	S	.		A	T	T	E	N	D	A	N	T	

3. Depress F13.

	A	T	T		O	V	E	R	F	L	O	W		
	A	T	T	?										

4. Enter attendant number (1 ~ 4) to set.  
 Example: Attendant 2. (See Note 1).

	A	T	T		O	V	E	R	F	L	O	W		
A	T	T	2		—	→		A	T	T	?			

5. Enter second attendant number (1 ~ 4) where calls are to overflow to. Example: Attendant 4.

	A	T	T		O	V	E	R	F	L	O	W		
A	T	T	2		—	→		A	T	T	4			

6. Depress ENTER key. (See Note 2).

	A	T	T		O	V	E	R	F	L	O	W		
A	T	T	3		—	→		A	T	T	?			

7. Repeat steps 5 and 6 for other attendants as required.

8. Depress the SPKR key to go back on line.

**KEY FUNCTION (OFF LINE)**

<b>SPKR</b> - ON/OFF Line
<b>TEL #</b> - Enters new attendant
<b>F/W</b> - Increments attendant number
<b>CLEAR</b> - Clears overflow assignment
<b>ENTER</b> - Enters each assignment
<b>B/W</b> - Decrements attendant number

**GUIDE TO FEATURE PROGRAMMING**

MEMORY BLOCK BEING PROGRAMMED	MEMORY BLOCK THAT MUST BE PROGRAMMED	MEMORY BLOCK THAT MAY HAVE TO BE PROGRAMMED
<b>3A3</b>		<b>3A2</b>

All CPU levels.

**NOTES:**

1. During step 4 the display shows any previous assignment for the attendant to be set.
2. Depressing the ENTER key causes the display to increment to the next attendant number.

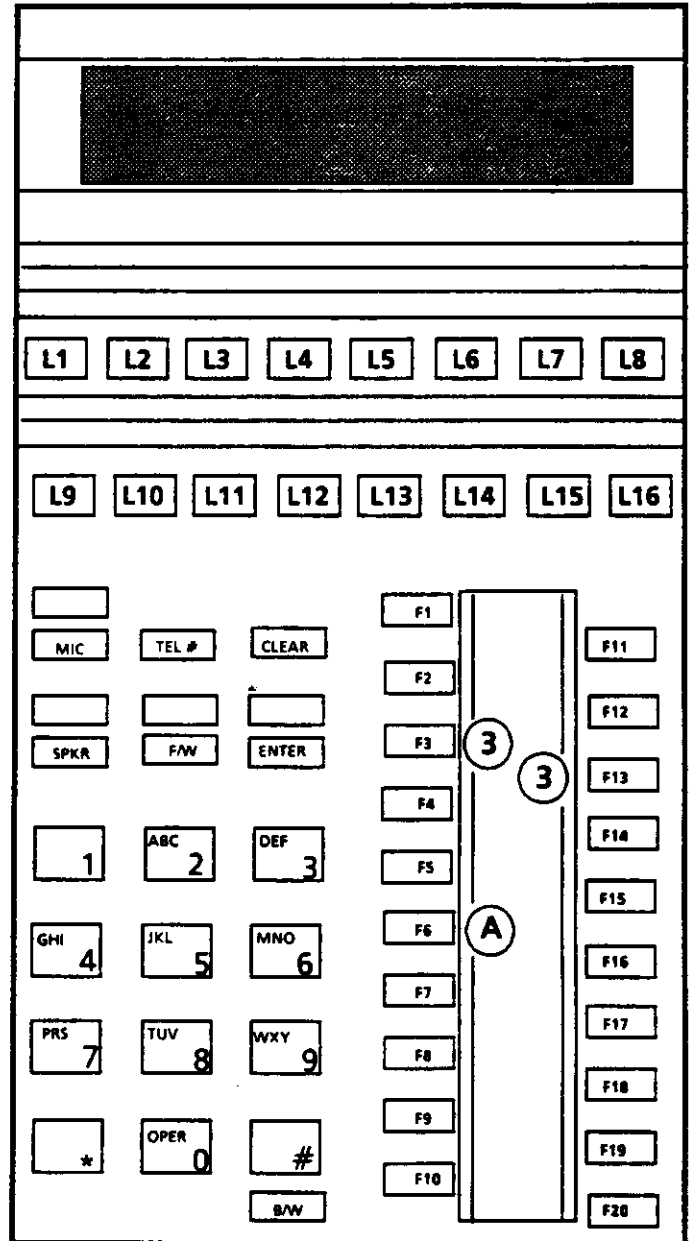

**GENERAL INFORMATION - ATTENDANT OVERFLOW ASSIGNMENT**

This area of the memory block is used to program the Overflow feature on the attendant positions.

### MEMORY BLOCK 3A4 - ATTENDANT TO TENANT ASSIGNMENT

OPERATION ← AND → DISPLAY

1. Go off line.

	O	F	F	-	L	I	N	E		(	X	.	X	X	)
	P	R	O	G	R	A	M		M	O	D	E			

2. Depress F3, then F6.

S	Y	S	.		A	T	T	E	N	D	A	N	T		

3. Depress F14. (See Note 1).

A	T	T	-	T	E	N	A	N	T		A	S	G	N	
A	T	T	1		-	-		T	E	N	A	N	T	1	

4. Depress F/W key. (See Note 3).

A	T	T	-	T	E	N	A	N	T		A	S	G	N	
A	T	T	2		-	-		T	E	N	A	N	T	X	

5. Dial the number corresponding to the Tenant (1 ~ 3) to be assigned. Example: Tenant 2. (See Note 4).

A	T	T	-	T	E	N	A	N	T		A	S	G	N	
A	T	T	2		-	-		T	E	N	A	N	T	2	

6. Depress ENTER key.

A	T	T	-	T	E	N	A	N	T		A	S	G	N	
A	T	T	X		-	-		T	E	N	A	N	T	X	

7. Repeat steps 5 and 6 for all attendants required. (See Note 2).

8. Depress the SPKR key to go back on line.

**KEY FUNCTION (OFF LINE)**

<b>SPKR</b> - ON/OFF Line
<b>TEL #</b> - Returns to attendant 1
<b>F/W</b> - Increments attendant number set
<b>CLEAR</b> -
<b>ENTER</b> - Enters each assignment
<b>B/W</b> - Decrements attendant number set

**GUIDE TO FEATURE PROGRAMMING**

MEMORY BLOCK BEING PROGRAMMED	MEMORY BLOCK THAT MUST BE PROGRAMMED	MEMORY BLOCK THAT MAY HAVE TO BE PROGRAMMED
<b>3A4</b>		3A2, 3A3
		1C1, 1D8

All CPU levels.

**NOTES:**

1. During step 3 the display shows any current assignment for the attendant to be set.
2. The 3rd and/or 4th attendants must first be allowed in memory block 3A2 before assigning them to a tenant.
3. ATTENDANT 1 is always assigned to TENANT 1.
4. This assignment cannot be made when:
  - any station is assigned to this attendant (1D8).
  - any DSS/BLF console is assigned to this attendant (1C1).

Therefore, all related assignments must first be cleared to allow this assignment to be made.

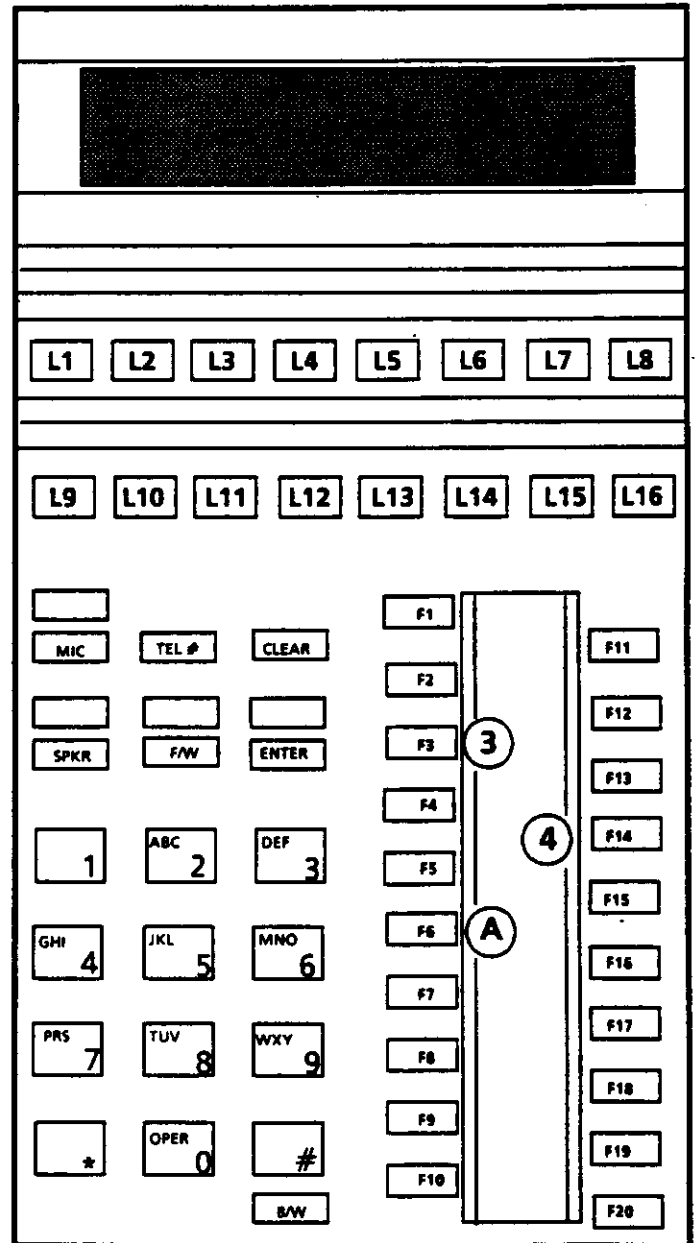

**GENERAL INFORMATION - ATTENDANT TO TENANT ASSIGNMENT**

This area of the memory block is used to assign the four possible system attendants to a particular tenant(s). A maximum of three Tenants are available.

### MEMORY BLOCK 3B1 - FIRST RING PATTERN ASSIGNMENT

OPERATION ← AND → DISPLAY

1. Go off line.

O	F	F	.	L	I	N	E		(	X	.	X	X	)
P	R	O	G	R	A	M		M	O	D	E			

2. Depress F3, then F7.

S	Y	S	2	.		F	E	A	T	U	R	E	1	

3. Depress F11.

1	S	T		R	I	N	G		P	A	T	T	E	R	N
D	E	P	R	E	S	S		L	I	N	E		K	E	Y

4. Depress L1 to L8 to assign the appropriate first ring pattern to the desired Trunk Groups.  
 Repetitive depression of those line keys toggles corresponding LED indications between ON and OFF.

LED ON: 1Hz interrupted tone (0.5 sec. ON,  
 0.5 sec. OFF)

LED OFF: 2 secs ON, 4 secs OFF (Default)  
 (See Notes 1 and 2).

5. Depress ENTER key.

1	S	T		R	I	N	G		P	A	T	T	E	R	N
D	E	P	R	E	S	S		L	I	N	E		K	E	Y

6. Depress SPKR key to go back on line.



**KEY FUNCTION (OFF LINE)**

SPKR - ON/OFF Line
TEL # -
F/W (Forward) -
CLEAR -
ENTER - Assigns desired 1st. ring pattern
B/W (Backward) -

**GUIDE TO FEATURE PROGRAMMING**

MEMORY BLOCK BEING PROGRAMMED	MEMORY BLOCK THAT MUST BE PROGRAMMED	MEMORY BLOCK THAT MAY HAVE TO BE PROGRAMMED
<b>3B1</b>		3B2, 4B6

CPU-EB3 or higher.  
 NOTES:

1. Line key and Trunk Group correspondence.

- LK1 = Trunk Group 1
- LK2 = Trunk Group 2
- LK3 = Trunk Group 3
- LK4 = Trunk Group 4
- LK5 = Trunk Group 5
- LK6 = Trunk Group 6
- LK7 = Trunk Group 7
- LK8 = Trunk Group 8

2. This assignment is valid for COI-EB as well as for COI-E and TLI-E ( ).

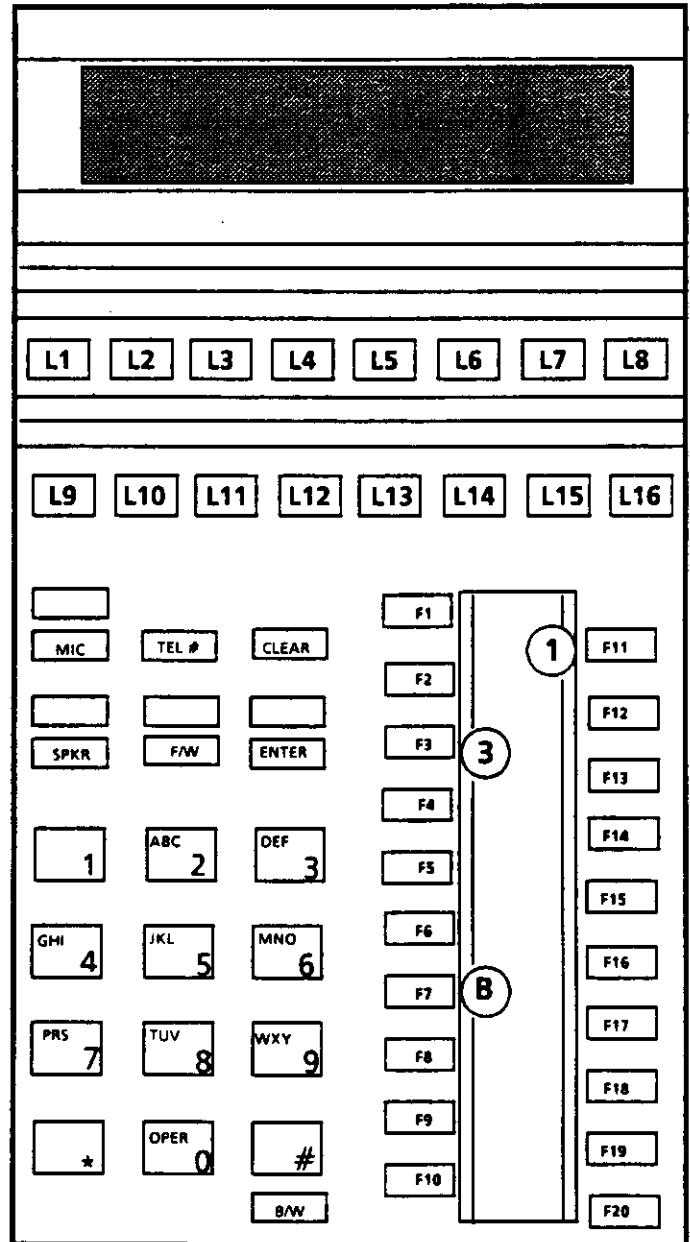

**GENERAL INFORMATION - FIRST RING PATTERN ASSIGNMENT**

This area of the memory block is used to assign in a Trunk Group basis, one of the 2 available ring patterns, to the 1st. ring cycle, after an incoming call is detected.

**MEMORY BLOCK 3B2 - CENTREX RINGING ASSIGNMENT**

OPERATION ← AND → DISPLAY

1. Go off line.

	O	F	F	-	L	I	N	E		(	X	.	X	X	)		
	P	R	O	G	R	A	M		M	O	D	E					

2. Depress F3, then F7.

S	Y	S	2	.		F	E	A	T	U	R	E	1				

3. Depress F12.

C	E	N	T	R	E	X		R	I	N	G	I	N	G			
T	R	U	N	K		G	R	O	U	P	?						

4. Dial Trunk Group number (1~8) to be assigned.  
 Example: Trunk Group 1

C	T	X		R	I	N	G			T	R	K	.	G	1		
D	E	P	R	E	S	S		L	I	N	E		K	E	Y		

5. Depress L1 to L8 to assign the appropriate ring pattern and detection time(s) to the Trunk Group selected. (See Note 1.)

LED ON: 1 Hz interrupted tone (0.5 sec. ON, 0.5 sec. OFF)

LED OFF: 2 sec ON, 4 sec OFF tone (Default)

6. Depress ENTER key. (See Note 2).

C	T	X		R	I	N	G			T	R	K	.	G	2		
D	E	P	R	E	S	S		L	I	N	E		K	E	Y		

7. Repeat steps 5 and 6 to assign all Trunk Groups required, or depress TEL# to assign a specific Trunk Group.

8. Depress SPKR key to go back on line.

**KEY FUNCTION (OFF LINE)**

SPKR - ON/OFF Line
TEL # - Selects Trunk Group number
F/W - Increments Trunk Group number
CLEAR -
ENTER - Enters each assignment
B/W - Decrements Trunk Group number

**GUIDE TO FEATURE PROGRAMMING**

MEMORY BLOCK BEING PROGRAMMED	MEMORY BLOCK THAT MUST BE PROGRAMMED	MEMORY BLOCK THAT MAY HAVE TO BE PROGRAMMED
3B2	4B6	3B1

CPU-EB3 or higher.

**NOTES:**

- Line key and incoming ring duration time correspondence.
  - LK1 = Less than 0.1 sec
  - LK2 = More than 0.1 sec but less than 0.3 sec
  - LK3 = More than 0.3 sec but less than 0.45 sec
  - LK4 = More than 0.45 sec but less than 0.65 sec
  - LK5 = More than 0.65 sec but less than 0.9 sec
  - LK6 = More than 0.9 sec but less than 1.5 sec
  - LK7 = More than 1.5 sec but less than 2.5 sec
  - LK8 = More than 2.5 sec
- Depressing the ENTER key increments the display to the next Trunk Group number.
- The Trunk Group number is incremented or decremented with the F/W and B/W keys.
- This assignment is valid for CENTREX or PBX Lines connected to COI-EB ETUs.

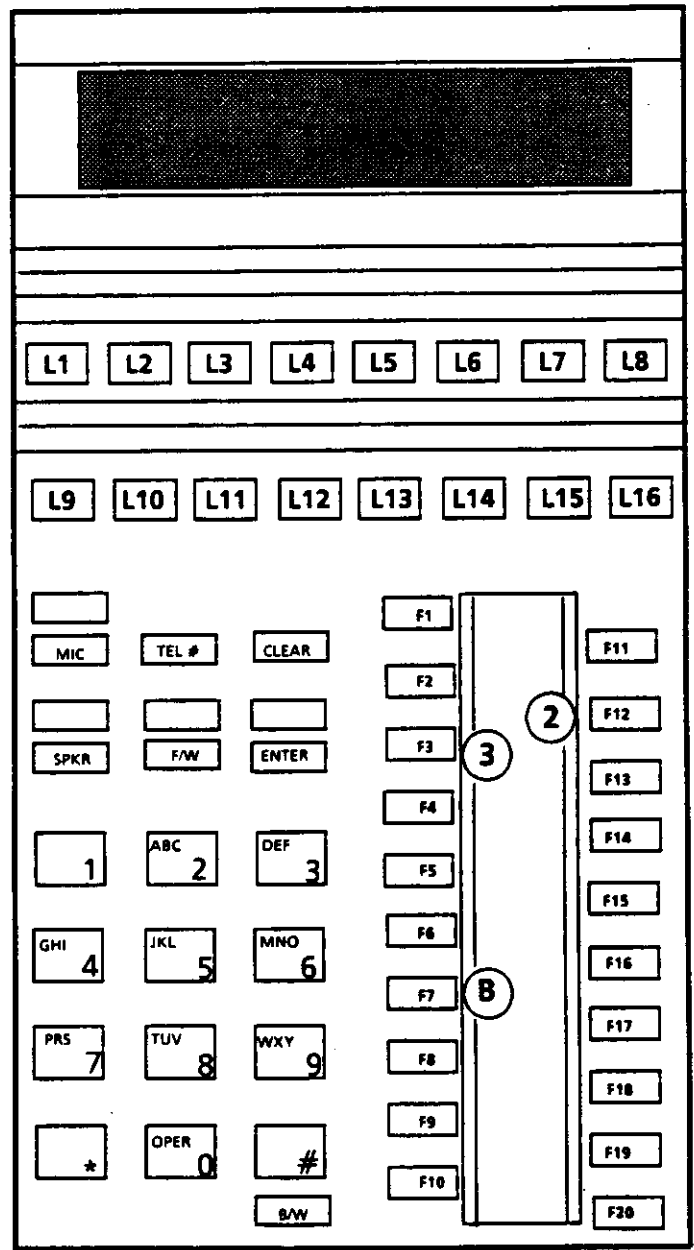

**GENERAL INFORMATION - CENTREX RINGING ASSIGNMENT**

This area of the memory block is used to assign one of the two Ring Patterns available to particular types of incoming ring signals. The assignments correspond to the duration of the incoming ring signals and are programmed in a Trunk Group basis.

**MEMORY BLOCK 3B3 - FORCED ACCOUNT CODE DIGIT ASSIGNMENT**

OPERATION      ← AND →      DISPLAY

1. Go off line.

	O	F	F	-	L	I	N	E		(	X	.	X	X	)
	P	R	O	G	R	A	M		M	O	D	E			

2. Depress F3, then F7.

S	Y	S	2	.		F	E	A	T	U	R	E	1		

3. Depress F13.  
 (See Note 1).

F	O	R	C	E	D		A	C	C		C	O	D	E	
N	O	.		O	F		D	I	G	I	T	S		1	0

4. Enter number of digits for the Forced Account Codes. Example: 12  
 (See Note 2)

F	O	R	C	E	D		A	C	C		C	O	D	E	
N	O	.		O	F		D	I	G	I	T	S		1	2

5. Depress ENTER key.  
 (See Note 3).

F	O	R	C	E	D		A	C	C		C	O	D	E	
N	O	.		O	F		D	I	G	I	T	S		1	2

6. Depress SPKR key to go back on line.

**KEY FUNCTION (OFF LINE)**

<b>SPKR</b> - ON/OFF Line
<b>TEL #</b> - Select number of Forced Account Code digits
<b>F/W</b> -
<b>CLEAR</b> -
<b>ENTER</b> - Enters each assignment
<b>B/W</b> -

**GUIDE TO FEATURE PROGRAMMING**

MEMORY BLOCK BEING PROGRAMMED	MEMORY BLOCK THAT MUST BE PROGRAMMED	MEMORY BLOCK THAT MAY HAVE TO BE PROGRAMMED
<b>3B3</b>	2E1	1D7

CPU-EB3 or higher.  
**NOTES:**

1. During step 3, any previous value already set is displayed.
2. Forced Account Code digit count assignment is 1 to 13 digits. Default assignment is 10 digits.
3. A change in the number of digits cannot be made unless all the previous Forced Account Code entries are cleared first at an Attendant position.

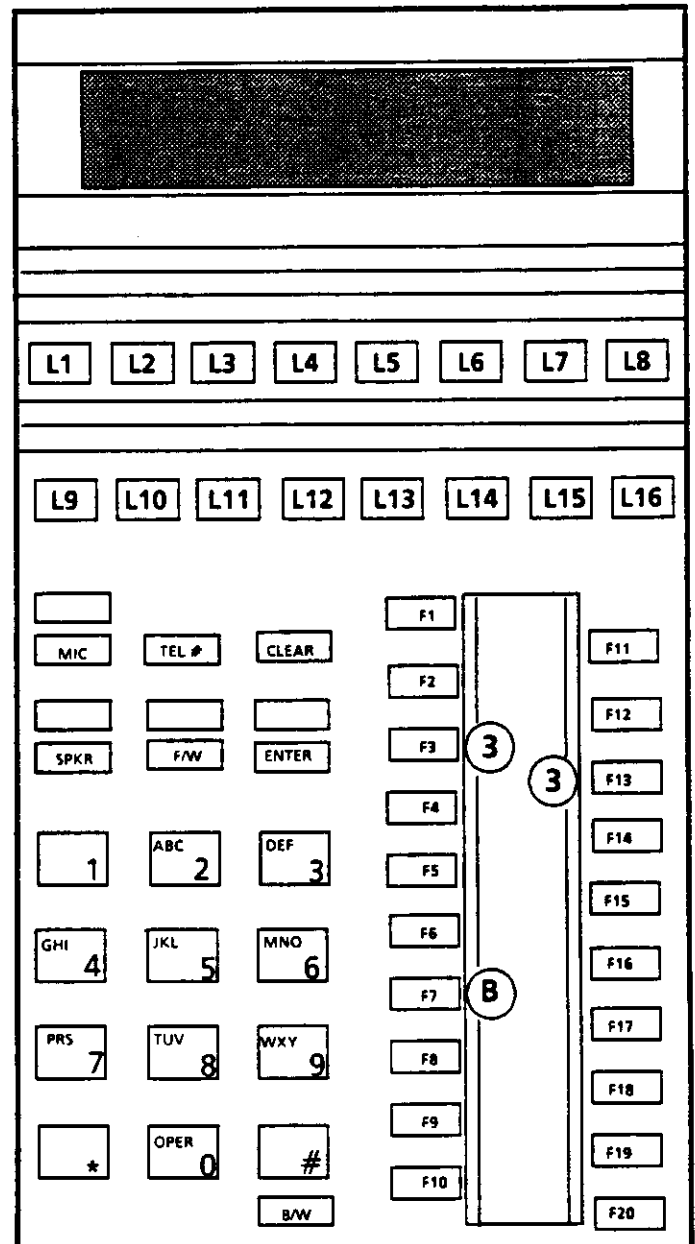

**GENERAL INFORMATION - FORCED ACCOUNT CODE DIGIT ASSIGNMENT**

This area of the memory block is used to assign the number of digits (1~13) for the Forced Account Codes.

**MEMORY BLOCK 3B4 - RAA SLT ASSIGNMENT**

OPERATION ← AND → DISPLAY

1. Go off line.

O	F	F	-	L	I	N	E		(	X	.	X	X	)
P	R	O	G	R	A	M		M	O	D	E			

2. Depress F3, then F7.

S	Y	S	2	.		F	E	A	T	U	R	E	1	

3. Depress F14.

	R	A	A	-	S	L	T		A	S	S	I	G	N	.
S	L	T	?	?	?			T	E	R	M	?	?	?	

4. Dial station number of the SLT port associated with the RAA and then station number of RAA.  
 Example: Station No. of SLT = 150  
 Station No. of RAA = 104

	R	A	A	-	S	L	T		A	S	S	I	G	N	.
S	L	T	1	5	0			T	E	R	M	1	0	4	

5. Depress ENTER key.
6. Depress SPKR key to go back on line.

**KEY FUNCTION (OFF LINE)**

SPKR - ON/OFF Line
TEL # - Select Station numbers
F/W (Forward) -
CLEAR - Clears station numbers
ENTER - Enter RAA SLT assignment
B/W (Backward) -

**GUIDE TO FEATURE PROGRAMMING**

MEMORY BLOCK BEING PROGRAMMED	MEMORY BLOCK THAT MUST BE PROGRAMMED	MEMORY BLOCK THAT MAY HAVE TO BE PROGRAMMED
<b>3B4</b>		1E2

CPU-EB3 or higher.  
 NOTES:

1. Default assignment is No Correspondence.
2. To clear the setting, during step 3 depress the CLEAR key and then the ENTER key.

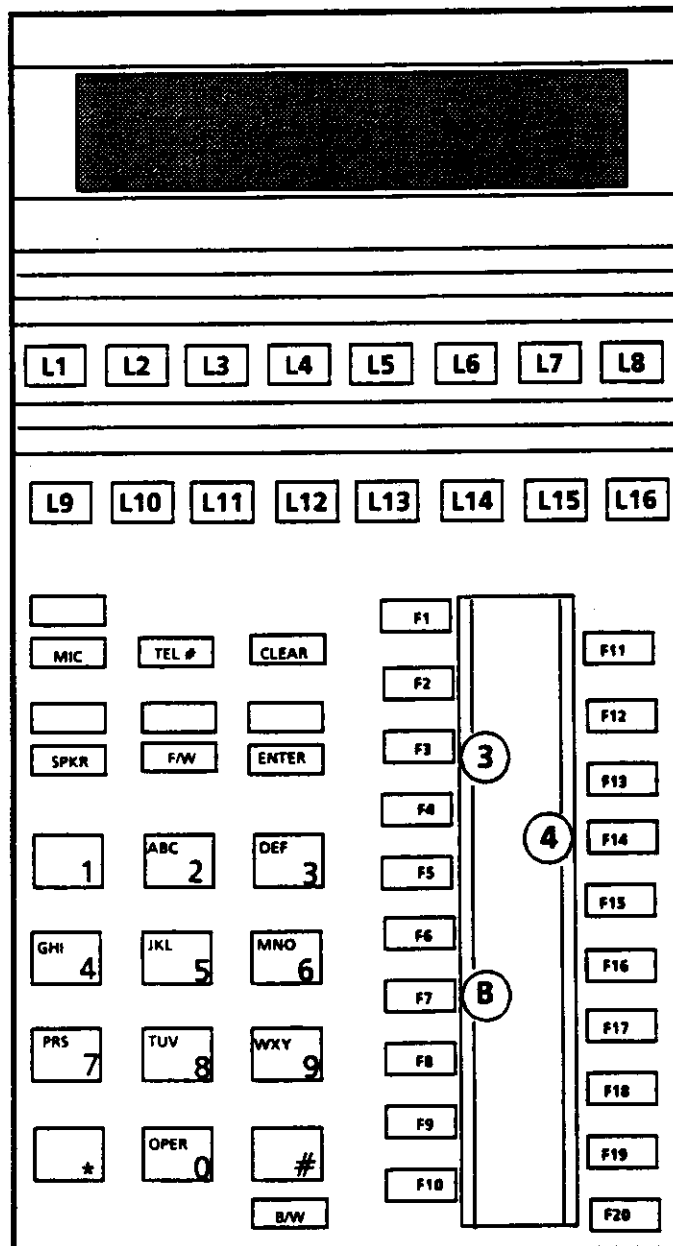

**GENERAL INFORMATION - RAA SLT ASSIGNMENT**

This area of the memory block is used to assign a guaranteed connection between the RAA and an SLT modem port. Remote maintenance operation is guaranteed by this assignment.

## MEMORY BLOCK 3B5 - STATION HUNTING PILOT NUMBER ASSIGNMENT

OPERATION ← AND → DISPLAY

1. Go off line.
 

	O	F	F	-	L	I	N	E		(	X	.	X	X	)	
	P	R	O	G	R	A	M		M	O	D	E				
  
2. Depress F3, then F7.
 

S	Y	S	2	.		F	E	A	T	U	R	E	1			
  
3. Depress F15.
 

H	U	N	T	.	G	-	P	I	L	O	T		N	O	.	
H	U	N	T	.	G	?										
  
4. Dial the STATION HUNT GROUP NO. (1-8).  
 Example: HUNT G. No. = 2
 

H	U	N	T	.	G	-	P	I	L	O	T		N	O	.	
H	N	T	.	G	2	-	P	I	L	O	T	?	?	?		
  
5. Dial the HUNT GROUP PILOT NO. (EXT NO. other than PE and VE).  
 Example: PILOT NO. = 190
 

H	U	N	T	.	G	-	P	I	L	O	T		N	O	.	
H	N	T	.	G	2	-	P	I	L	O	T	1	9	0		
  
6. Depress ENTER key. (See Note 1).
 

H	U	N	T	.	G	-	P	I	L	O	T		N	O	.	
H	N	T	.	G	3	-	P	I	L	O	T	?	?	?		
  
7. Repeat Steps 3 to 5 for the HUNT GROUPS to be specified.
  
8. Depress SPKR key to go back on line.



**KEY FUNCTION (OFF LINE)**

<b>SPKR - ON/OFF Line</b>
<b>TEL # - Selects a new Hunt Group number</b>
<b>F/W - Increments the Hunt Group number</b>
<b>CLEAR - Clears Pilot Number Assignment</b>
<b>ENTER - Enters each assignment</b>
<b>B/W - Decrements Hunt Group number</b>

**GUIDE TO FEATURE PROGRAMMING**

MEMORY BLOCK BEING PROGRAMMED	MEMORY BLOCK THAT MUST BE PROGRAMMED	MEMORY BLOCK THAT MAY HAVE TO BE PROGRAMMED
<b>3B5</b>	<b>3B6</b>	<b>3B7, 3B8</b>

CPU-EB3 or higher.  
**NOTES:**

1. Depressing the ENTER key shifts the assignment HUNT GROUP to the next group number.

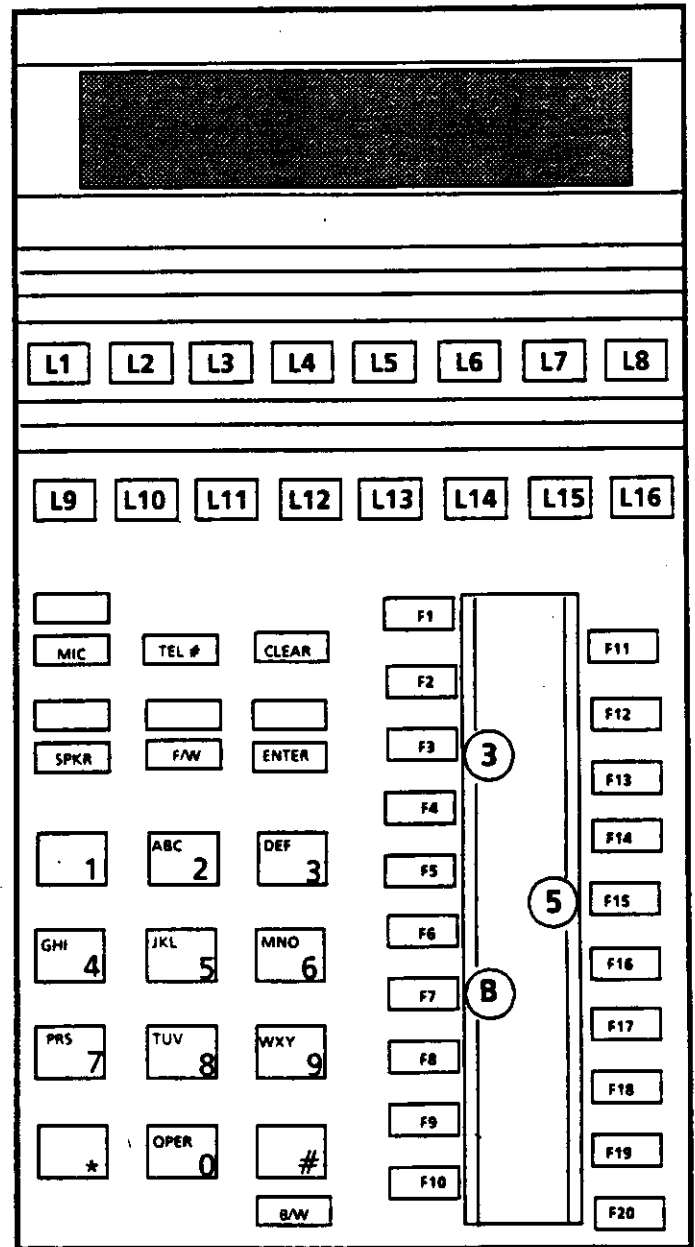

**GENERAL INFORMATION - STATION TO HUNT GROUP PILOT NUMBER ASSIGNMENT**

This area of the memory block is used to assign the Pilot No. to the Hunt Group No. (1-8).

### MEMORY BLOCK 3B6 - STATION TO HUNT GROUP ASSIGNMENT

OPERATION ← AND → DISPLAY

1. Go off line.
 

	O	F	F	-	L	I	N	E		(	X	.	X	X	)	
	P	R	O	G	R	A	M		M	O	D	E				
  
2. Depress F3, then F7.
 

S	Y	S	2	.		F	E	A	T	U	R	E	1			
  
3. Depress F16.
 

S	T	A	T	I	O	N		H	U	N	T	.	G			
H	U	N	T	.	G	?										
  
4. Dial the required STATION HUNT GROUP NO. (1-8).  
 Example: HUNT GROUP No. = 2
 

S	T	A	T	I	O	N		H	U	N	T	.	G	2		
0	1	-	E	X	T	E	N	S	I	O	N	?	?	?		
  
5. Dial an EXT NO. to be assigned as a member of this STATION HUNT GROUP.  
 Example: EXT No. = 100 (See Notes 1)
 

S	T	A	T	I	O	N		H	U	N	T	.	G			
0	1	-	E	X	T	E	N	S	I	O	N	1	0	0		
  
6. Depress ENTER key. (See Notes 2)
 

S	T	A	T	I	O	N		H	U	N	T	.	G	2		
0	2	-	E	X	T	E	N	S	I	O	N	?	?	?		
  
7. Repeat Steps 3 to 5 for the HUNT GROUPS to be assigned.
 

S	T	A	T	I	O	N		H	U	N	T	.	G			
H	U	N	T	.	G	?										
  
8. Depress SPKR key to go back on line.

**KEY FUNCTION (OFF LINE)**

<b>SPKR</b> - ON/OFF Line
<b>TEL #</b> - Selects a new Hunt Group number
<b>F/W</b> - Increments extension number
<b>CLEAR</b> - Clears extension assignment
<b>ENTER</b> - Enters each assignment
<b>B/W</b> - Decrements extension number

**GUIDE TO FEATURE PROGRAMMING**

MEMORY BLOCK BEING PROGRAMMED	MEMORY BLOCK THAT MUST BE PROGRAMMED	MEMORY BLOCK THAT MAY HAVE TO BE PROGRAMMED
<b>3B6</b>	3B5	3B7, 3B8

CPU-EB3 or higher.

**NOTES:**

1. Only VEs and telephone numbers can be programmed as members of a HUNT GROUP (16 max.). Pilot numbers or uniform numbers are not accepted. The same extension can be programmed to appear on more than one HUNT GROUP. The same extension can be programmed to appear more than once on a HUNT GROUP.
2. Depressing the ENTER key advances this program to the next extension entry within the same hunt group.

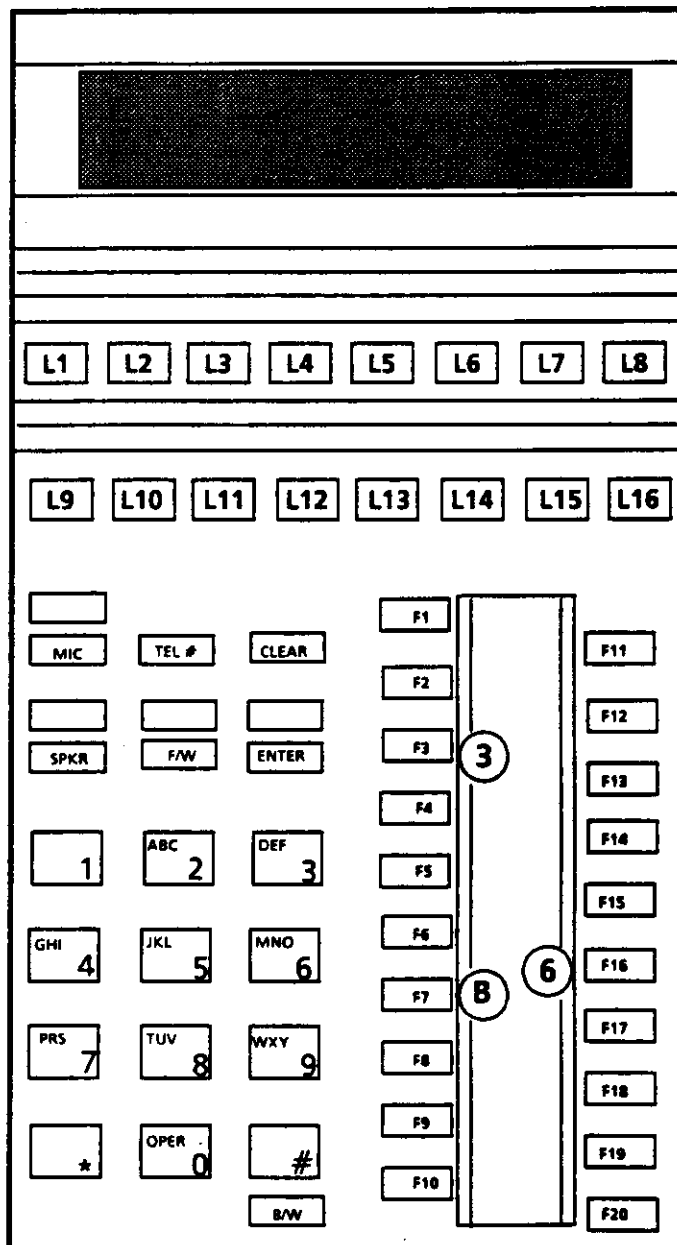

**GENERAL INFORMATION - STATION TO HUNT GROUP ASSIGNMENT**

This area of the memory block is used to assign extension numbers to the various Hunt groups (1-8).

**MEMORY BLOCK 3B7 - STATION HUNT TYPE ASSIGNMENT**

OPERATION ← AND → DISPLAY

1. Go off line.

	O	F	F	-	L	I	N	E		(	X	.	X	X	)
	P	R	O	G	R	A	M		M	O	D	E			

2. Depress F3, then F7.

S	Y	S	2	.		F	E	A	T	U	R	E	1		

3. Depress F17.

H	U	N	T		S	E	A	R	C	H					
H	U	N	T	.	G	?									

4. Dial the HUNT GROUP NO. (1-8) for which the search method is to be assigned.  
 Example: HUNT GROUP NO.=1

H	U	N	T		S	E	A	R	C	H					
H	U	N	T	.	G	1		L	I	N	E	A	R		

5. Assign the search method.  
 Depress LK1 key.  
 LED OFF: LINEAR (Default)  
 LED ON: CIRCULAR

H	U	N	T		S	E	A	R	C	H					
H	U	N	T	.	G	1		C	I	R	C	U	L	A	R

6. Depress ENTER key (See Note 1).

H	U	N	T		S	E	A	R	C	H					
H	U	N	T	.	G	2		L	I	N	E	A	R		

7. Depress SPKR key to go back on line.

**KEY FUNCTION (OFF LINE)**

<b>SPKR</b> - ON/OFF Line
<b>TEL #</b> - Selects a new Hunt Group number
<b>F/W</b> - Increments Hunt Group number
<b>CLEAR</b> -
<b>ENTER</b> - Enters each assignment
<b>B/W</b> - Decrements Hunt Group number

**GUIDE TO FEATURE PROGRAMMING**

MEMORY BLOCK BEING PROGRAMMED	MEMORY BLOCK THAT MUST BE PROGRAMMED	MEMORY BLOCK THAT MAY HAVE TO BE PROGRAMMED
<b>3B7</b>	3B5, 3B6	3B8

CPU-EB3 or higher.

**NOTES:**

1. Depressing the ENTER key advances this program to the next HUNT GROUP.

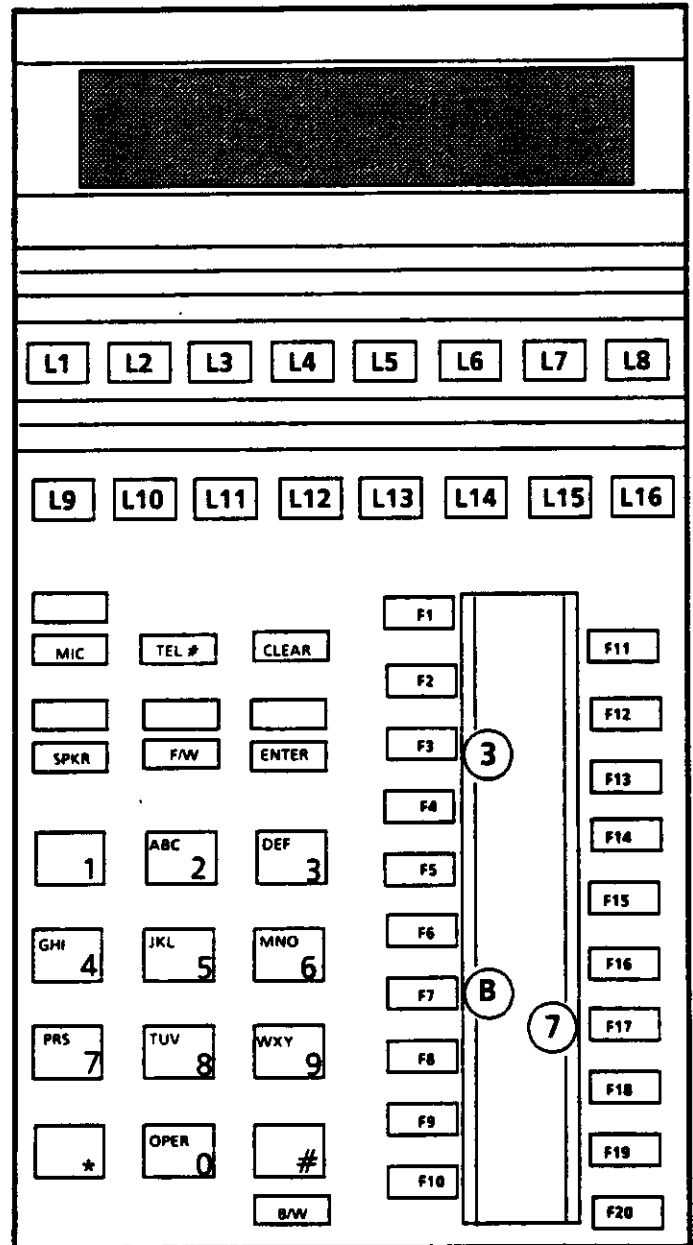

**GENERAL INFORMATION - STATION HUNT TYPE ASSIGNMENT**

This area of the memory block is used to assign the Hunt Search method for each Hunt Group.

- Linear (Default)
- Circular

**MEMORY BLOCK 3B8 - STATION HUNT GROUP FORWARD ASSIGNMENT**

OPERATION ← AND → DISPLAY

1. Go off line.

	O	F	F	-	L	I	N	E		(	X	.	X	X	)
	P	R	O	G	R	A	M		M	O	D	E			

2. Depress F3, then F7.

S	Y	S	2	.		F	E	A	T	U	R	E	1		

3. Depress F18.

H	U	N	T	.	G		F	W	D		A	S	G	N	
H	U	N	T	.	G	?									

4. Dial the STATION HUNT GROUP NO. (1-8) for which the HUNT FORWARD destination is to be assigned.

Example: HUNT G. NO. = 1.

H	U	N	T	.	G		F	W	D		A	S	G	N	
H	U	N	T	.	G	1	-	F	W	D	?	?	?		

5. Dial an EXT NO. or HUNT PILOT NO. as the HUNT FORWARD NO.

Example: EXT No. = 300

H	U	N	T	.	G		F	W	D		A	S	G	N	
H	U	N	T	.	G	1	-	F	W	D	3	0	0		

6. Depress ENTER key. (See Note 1).

H	U	N	T	.	G		F	W	D		A	S	G	N	
H	U	N	T	.	G	2	-	F	W	D	?	?	?		

7. Repeating Steps 3 to 5 until station hunt forward destinations can be registered for all the HUNT GROUPS.

8. Depress SPKR key to go back on line.

**KEY FUNCTION (OFF LINE)**

<b>SPKR</b> - ON/OFF Line
<b>TEL #</b> - Selects a new Hunt Group number
<b>F/W</b> - Increments Hunt Group number
<b>CLEAR</b> - Clears FWD destination assignment
<b>ENTER</b> - Enters each assignment
<b>B/W</b> - Decrements Hunt Group number

**GUIDE TO FEATURE PROGRAMMING**

MEMORY BLOCK BEING PROGRAMMED	MEMORY BLOCK THAT MUST BE PROGRAMMED	MEMORY BLOCK THAT MAY HAVE TO BE PROGRAMMED
<b>3B8</b>	385, 3B6	3B7

CPU-EB3 or higher.

**NOTES:**

1. Depressing the ENTER key advances this program to the next HUNT GROUP.

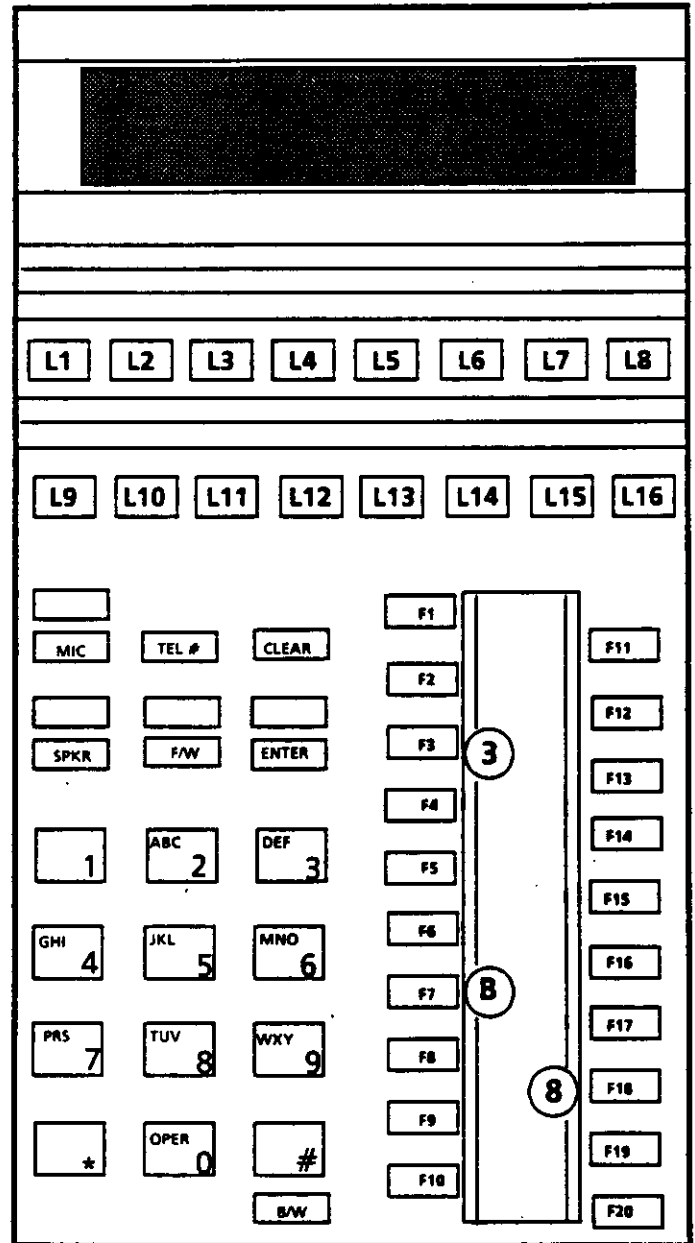

**GENERAL INFORMATION - STATION HUNT GROUP FORWARD ASSIGNMENT**

This area of the memory block is used to assign an extension No. or Hunt Group Pilot No. as the Forward destination of a DIT or DID incoming call when all extensions in the Hunt Group are busy..

## MEMORY BLOCK 3B9 - TRUNK GROUP TO LINE POOL GROUP ASSIGNMENT

OPERATION ← AND → DISPLAY

1. Go off line.

O	F	F	-	L	I	N	E		(	X	.	X	X	)
P	R	O	G	R	A	M		M	O	D	E			

2. Depress F3, then F7.

S	Y	S	2	.		F	E	A	T	U	R	E	1	

3. Depress F19.

	T	R	U	N	K	.	G	-	P	O	O	L	.	G
L	I	N	E		P	O	O	L		G	R	P	-	?

4. Dial Pool Group number (1 to 8).  
 Example: Pool Group 2. (See Note 1).

	T	R	U	N	K	.	G	-	P	O	O	L	.	G
L	I	N	E		P	O	O	L		G	R	P	-	2

5. Depress L1 to L8 to assign the appropriate trunk groups to the Pool Group chosen. (See Note 2).
6. Depress ENTER key. (See Note 3).
7. Repeat Steps 5 and 6 to assign Trunk Groups to all the desired Pool Groups, or depress TEL# key to program a specific Pool Group.
8. Depress SPKR key to go back on line.



**KEY FUNCTION (OFF LINE)**

<b>SPKR - ON/OFF Line</b>
<b>TEL # - Enters new pool group number</b>
<b>F/W (Forward) - Increments pool group number</b>
<b>CLEAR -</b>
<b>ENTER - Enters each assignment</b>
<b>B/W (Backward) - Decrements pool group number</b>

**GUIDE TO FEATURE PROGRAMMING**

MEMORY BLOCK BEING PROGRAMMED	MEMORY BLOCK THAT MUST BE PROGRAMMED	MEMORY BLOCK THAT MAY HAVE TO BE PROGRAMMED
<b>3B9</b>	<b>1A</b>	<b>3B10</b>

CPU-EB3 or higher.

**NOTES:**

1. During Step 3, any previous Trunk Group assignment for the Pool Group entered is shown by the LED pattern of L1 to L8.
2. In assigning the Trunk Groups to a specific Pool Group in Step 4, the following procedure is used: L1 to L8 correspond to Trunk Groups 1 to 8 respectively.  
 LED ON: Assigned to Pool Group  
 LED OFF: Not assigned to Pool Group
3. Depression of the ENTER key will increment the display to the next Pool Group number.

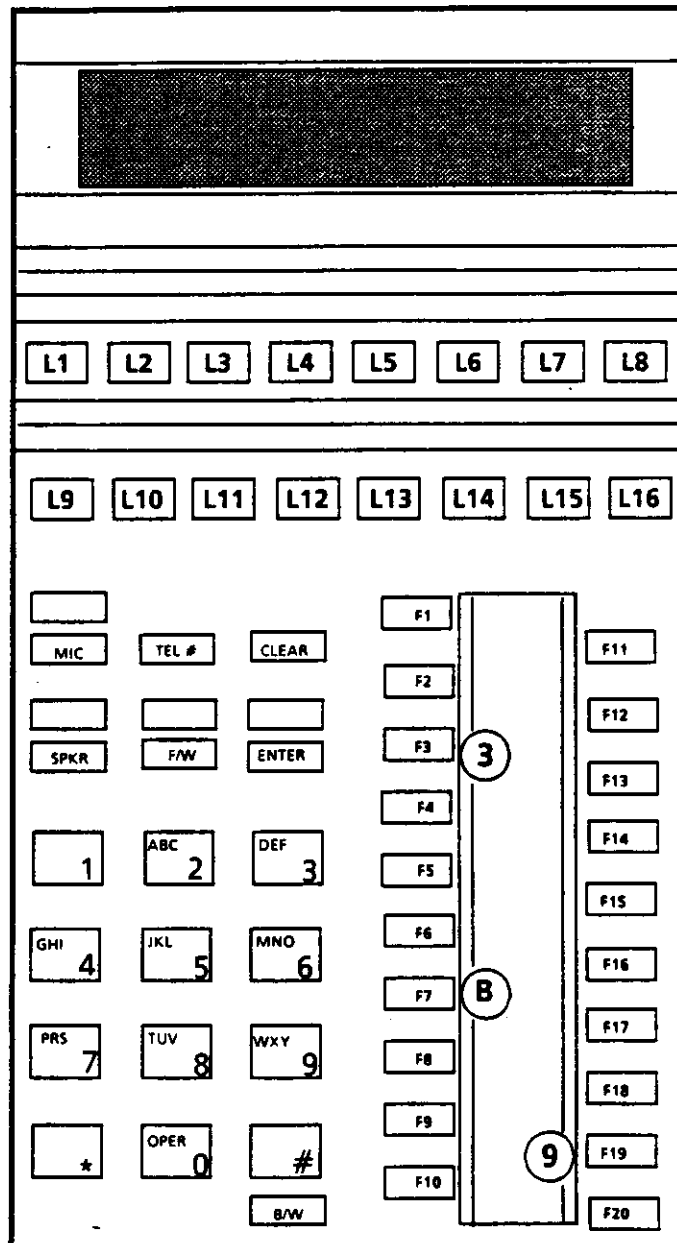

**GENERAL INFORMATION - TRUNK GROUP TO LINE POOL GROUP ASSIGNMENT**

This area of the memory block is used to assign up to eight system trunk groups to each of the pool groups.

## MEMORY BLOCK 3B10 - LINE POOL GROUP AUTO EXTENSION ASSIGNMENT

OPERATION ← AND → DISPLAY

1. Go off line.

	O	F	F	-	L	I	N	E		(	X	.	X	X	)
	P	R	O	G	R	A	M		M	O	D	E			

2. Depress F3, then F7.

S	Y	S	2	.		F	E	A	T	U	R	E	1		

3. Depress F20.

	P	O	O	L		A	U	T	O		E	X	T		
T	E	L	?	?	?										

4. Dial station number being assigned.  
 Example: Station 104

	P	O	O	L		A	U	T	O		E	X	T		
T	E	L	1	0	4										

5. Each extension line position L1 to L15 required to be a Pool Auto Extension (PAE) for the station chosen in Step 3 should be selected. (See Notes 1 & 2).  
 LED ON = Assign Pool Auto Extension  
 LED OFF = Do Not Assign pool auto extension

6. Depress ENTER key. (See Note 3).

7. Repeat Steps 5 and 6 until all desired Multiline Terminals are programmed or depress the TEL # key to program a particular station.

8. Depress SPKR key to go back on line.

**KEY FUNCTION (OFF LINE)**

SPKR - ON/OFF Line
TEL # - Select station to be assigned
F/W (Forward) - Increment station number
CLEAR -
ENTER - Entry to each station assigned
B/W (Backward) - Decrement station number

**GUIDE TO FEATURE PROGRAMMING**

MEMORY BLOCK BEING PROGRAMMED	MEMORY BLOCK THAT MUST BE PROGRAMMED	MEMORY BLOCK THAT MAY HAVE TO BE PROGRAMMED
<b>3B10</b>	1A	

CPU-EB3 or higher.

**NOTES:**

1. When programming appearances for a 6 button station, L1 ~ L5 are selected on the programming station.
2. The primary extension of the specified TEL is always set as a Pool Auto Extension and cannot be changed. (LED always ON)
3. Depressing the ENTER key causes the assignment to advance to the next station number.

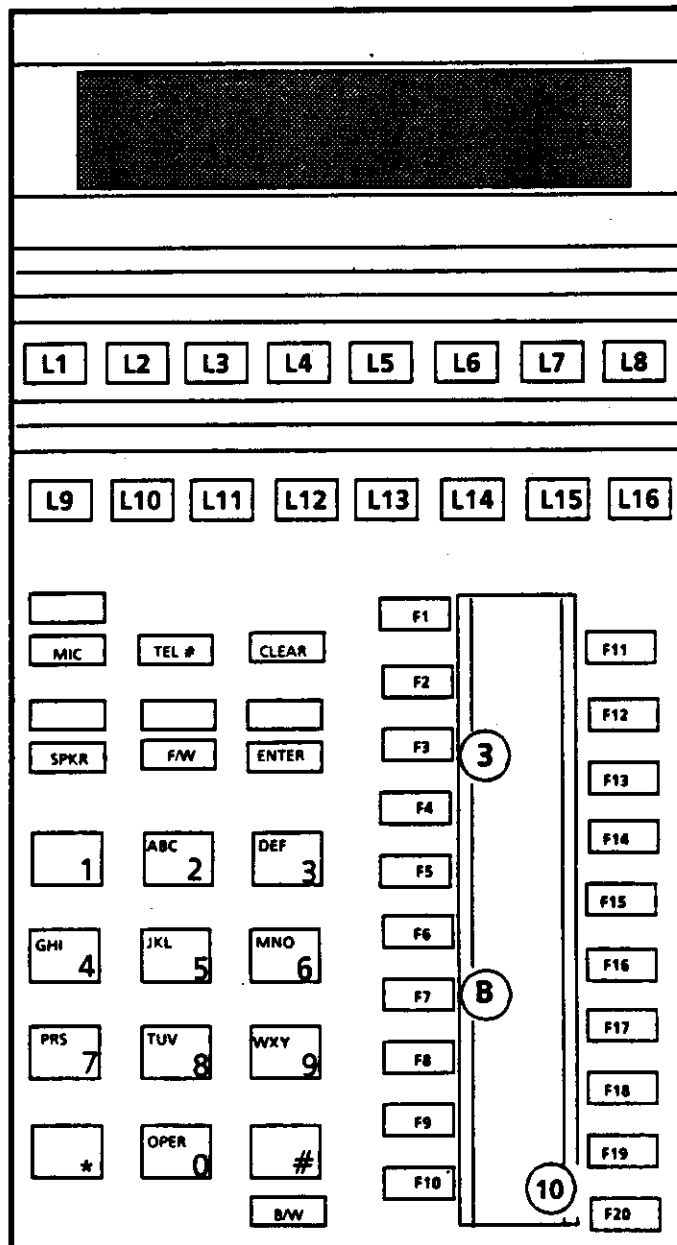

**GENERAL INFORMATION - LINE POOL GROUP AUTO EXTENSION ASSIGNMENT**

This area of the memory block is used to assign Line Pool Group Auto Extensions (PAEs) at line key appearance of Multiline Terminals. Primary extensions are automatically assigned as PAEs.

ATTENDANT STATIONS

101-02-102

ND-20292  
CHAPTER 3  
SEPTEMBER, 1988

MEMORY BLOCK 3C1 - TELEPHONE NAME ASSIGNMENT

OPERATION ← AND → DISPLAY

1. Go off line.

- 1. PRESS L16
- 2. PRESS SPKR
- 3. DIAL #\*0 LCD SHOWS OFF LINE.

	O	F	F	-	L	I	N	E		(	X	.	X	X	)
	P	R	O	G	R	A	M		M	O	D	E			

2. Depress F3, then F8.

S	Y	S	.		N	A	M	E		A	S	S	I	G	N

3. Depress F11.

T	E	L		N	A	M	E								
T	E	L	?	?	?										

4. Dial station number to be set.  
Example: Station 104. (See Note 1).

T	E	L		N	A	M	E	-	T	E	L	1	0	4	
N	A	M	E	;	X	X	X	X	X	X	X				

5. To enter the name STEVE: Enter the first letter to be set, depress the 7 dial key five times. (See Note 2).

T	E	L		N	A	M	E	-	T	E	L	1	0	4	
N	A	M	E	;	S										

6. Enter the second letter to be set, depress the 8 dial key twice. (See Note 2).

T	E	L		N	A	M	E	-	T	E	L	1	0	4	
N	A	M	E	;	S	T									

7. Repeat dialing sequence for all letters required. (See Note 3).

8. Depress ENTER key. (See Note 4).

T	E	L		N	A	M	E	-	T	E	L	1	0	5	
N	A	M	E	;	X	X	X	X	X	X	X				

9. Repeat from step 5 thru 7 for all stations required.

10. Depress the SPKR key to go back on line.

### KEY FUNCTION (OFF LINE)

<b>SPKR</b> - ON/OFF Line
<b>TEL #</b> - Enters station number
<b>F/W</b> - Increments to next character
<b>CLEAR</b> - Clears name
<b>ENTER</b> - Enters name assigned
<b>B/W</b> - Removes last character entered

### GUIDE TO FEATURE PROGRAMMING

MEMORY BLOCK BEING PROGRAMMED	MEMORY BLOCK THAT MUST BE PROGRAMMED	MEMORY BLOCK THAT MAY HAVE TO BE PROGRAMMED
<b>3C1</b>		

ALL CPU levels.

#### NOTES:

1. During step 4 the display shows any previous name assigned to the station chosen.
2. Each character is entered by selecting a dial key and depressing it a number of times. Use the table below as a guide. The F/W and B/W keys are used to move to the next or previous entry.

		DIAL PAD KEYS											
		1	2	3	4	5	6	7	8	9	0	*	#
DEPRESSIONS	1	1	2	3	4	5	6	7	8	9	0	*	#
	2	•	A	D	G	J	M	P	T	W	S	*	#
	3	•	B	E	H	K	N	Q	U	X	P	*	#
	4	•	C	F	I	L	O	R	V	Y	A	*	#
	5	SPACE						S	↑	Z	SPACE		

SPACE →

These Dial Pad Key patterns are repeated every six depressions.

3. The character string is limited to seven digits including spaces.
4. Depressing the ENTER key causes the display to increment to the next station number.

### GENERAL INFORMATION - TELEPHONE NAME ASSIGNMENT

This area of the memory block is used to assign user names to each station, and/or voice mail box.

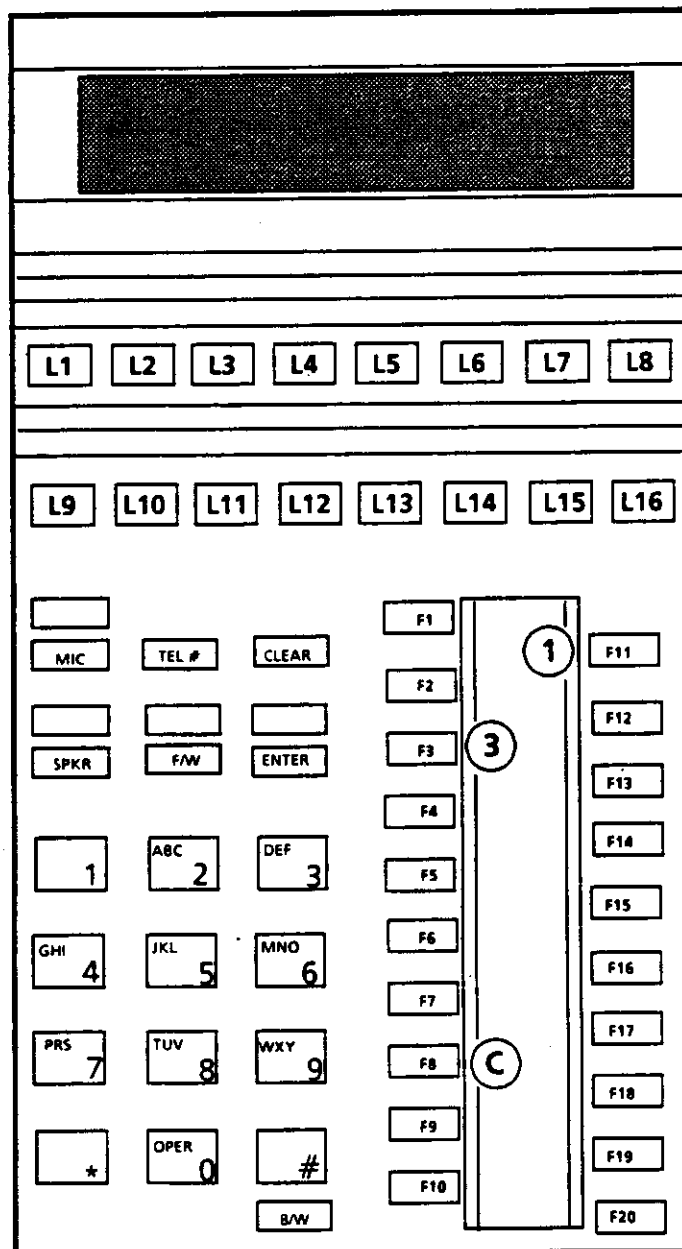

**MEMORY BLOCK 3C2 - TRUNK GROUP NAME ASSIGNMENT**

OPERATION ← AND → DISPLAY

1. Go off line.

O	F	F	-	L	I	N	E		(	X	.	X	X	)
P	R	O	G	R	A	M		M	O	D	E			

2. Depress F3, then F8.

S	Y	S	.		N	A	M	E		A	S	S	I	G	N

3. Depress F12.

T	R	U	N	K		G	R	O	U	P		N	A	M	E
T	R	U	N	K		G	R	O	U	P	?				

4. Dial the number of the trunk group (1~8) to be assigned. Example: Trunk Group 3. (See Note 1).

N	A	M	E		T	R	K		G	R	O	U	P	3	
N	A	M	E	;	-	-	-	-	-	-	-	-	-	-	

5. Using the dial pad, enter the desired name for the selected trunk group. Example: New York. (See Note 2).

N	A	M	E		T	R	K		G	R	O	U	P	3	
N	A	M	E	;	N	E	W		Y	O	R	K			

6. Depress ENTER key. (See Note 3).

T	R	U	N	K		G	R	O	U	P		N	A	M	E
T	R	U	N	K		G	R	O	U	P	?				

7. Repeat steps 4 and 6 for all trunk groups to be assigned names.

8. Depress SPKR key to go back on line.

**KEY FUNCTION (OFF LINE)**

<b>SPKR - ON/OFF Line</b>
<b>TEL # -</b>
<b>F/W - Skips to the next letter position</b>
<b>CLEAR - Clears current name assignment</b>
<b>ENTER - Enters each assignment</b>
<b>B/W - Moves back one letter position</b>

**GUIDE TO FEATURE PROGRAMMING**

MEMORY BLOCK BEING PROGRAMMED	MEMORY BLOCK THAT MUST BE PROGRAMMED	MEMORY BLOCK THAT MAY HAVE TO BE PROGRAMMED
<b>3C2</b>	<b>2C1</b>	

CPU-EB or higher.

**NOTES:**

1. After a trunk group has been selected, the display will show any previous name assignment. (Default name: COCALL).
2. The name assigned to each trunk group is limited to eight (8) characters, including spaces.

Each character is entered by selecting a dial key and depressing it a number of times. Use the table below as a guide. The F/W and B/W keys are used to move to the next or previous entry.

		DIAL PAD KEYS															
		1	2	3	4	5	6	7	8	9	0	*	#				
DEPRESSIONS	1	1	2	3	4	5	6	7	8	9	0	*	#				
	2	•	A	D	G	J	M	P	T	W	S	P	A	C	E	*	#
	3	•	B	E	H	K	N	Q	U	X						*	#
	4	•	C	F	I	L	O	R	V	Y						*	#
	5		SPACE						S	▲	Z	SPACE					

The dial pad key patterns repeat ever six depressions.

3. Depressing the ENTER key automatically advances the display to step 3.

**GENERAL INFORMATION - TRUNK GROUP NAME ASSIGNMENT**

This area of the memory block is used to assign names (of up to eight (8) characters, including spaces) to each trunk group. These names will appear in the displays of Multiline Terminals so equipped, when receiving ring transfered, DID, Tie line or DIT calls, to an idle extension.

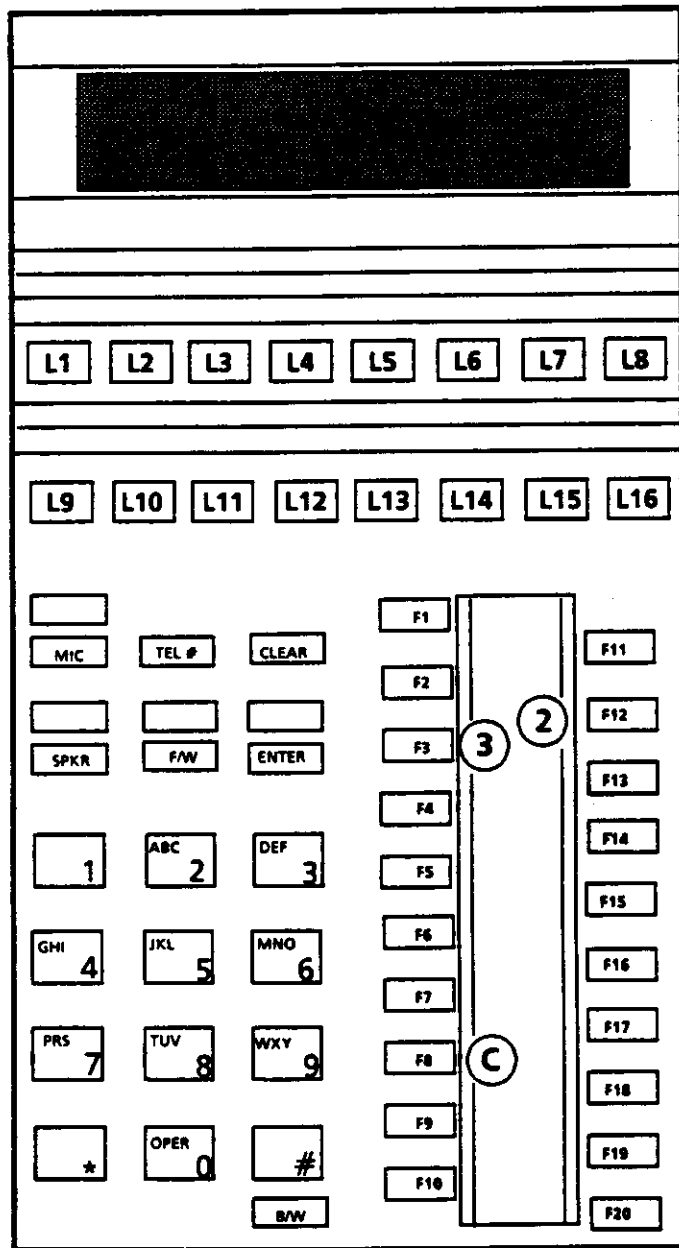

**MEMORY BLOCK 3D1 - FIRST INITIALIZATION**

OPERATION ← AND → DISPLAY

1. Go off line.

	O	F	F	-	L	I	N	E		(	X	.	X	X	)
	P	R	O	G	R	A	M		M	O	D	E			

2. Depress F3, then F9.

S	Y	S	.																

3. Depress F11.

	1	S	T																
	D	E	P	R	E	S	S												

4. Depress L1, L3, L5, L7, L9, L11, L13, and L15.

5. Depress the ENTER key. (See Notes 1 & 2).

**NOTE:** Briefly, the display on all stations will go blank, then INITIALIZE will be displayed momentarily before returning to the default values of time and date.





**KEY FUNCTION (OFF LINE)**

SPKR - ON/OFF Line
TEL # -
F/W -
CLEAR -
ENTER - First initialization command
B/W -

**GUIDE TO FEATURE PROGRAMMING**

MEMORY BLOCK BEING PROGRAMMED	MEMORY BLOCK THAT MUST BE PROGRAMMED	MEMORY BLOCK THAT MAY HAVE TO BE PROGRAMMED
<b>3D1</b>		

ALL CPU levels.

**NOTES:**

1. Depressing the ENTER key causes the system to reset and initialize. All current system and user programming is lost and the system data is returned to default. The programming station automatically returns to the ON LINE mode.
2. The initialization process causes all traffic in the system to be cut off.

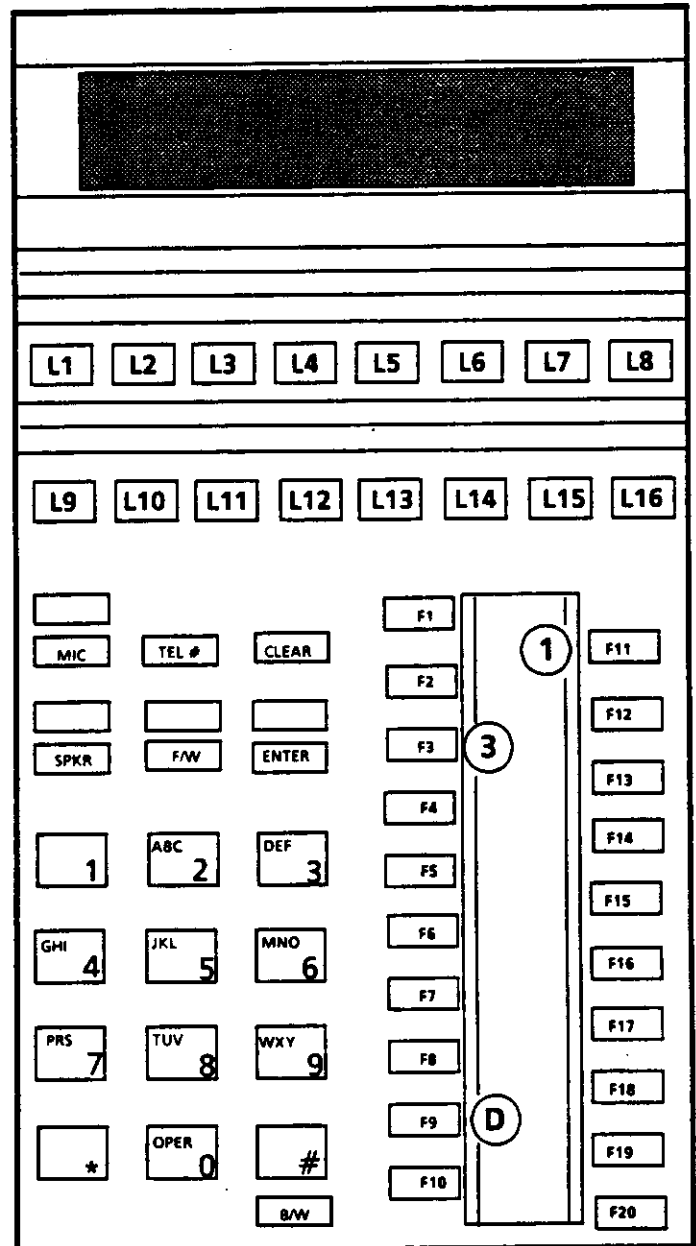

**GENERAL INFORMATION - FIRST INITIALIZATION**

This area of the memory block is used to reinitialize the system software and hardware. The system program is returned to default and all calls in progress are dropped.

**MEMORY BLOCK 3D2 - SECOND INITIALIZATION**

OPERATION ← AND → DISPLAY

1. Go off line.

	O	F	F	-	L	I	N	E		(	X	.	X	X	)
	P	R	O	G	R	A	M		M	O	D	E			

2. Depress F3, then F9.

S	Y	S	.		I	N	I	T	I	A	L	I	Z	E	

3. Depress F12.

	2	N	D		I	N	I	T	I	A	L	I	Z	E	

4. Depress ENTER key. (See Notes 1 and 2).

				I	N	I	T	I	A	L	I	Z	E		
				I	N	P	R	O	G	R	E	S	S		

**NOTE:** Briefly, the display on all stations will go blank, then INITIALIZE will be displayed momentarily before returning to time and date.

				I	N	I	T	I	A	L	I	Z	E		

0	4	:	1	5		N	O	V		2	5		T	U	E

**KEY FUNCTION (OFF LINE)**

SPKR - ON/OFF Line
TEL # -
F/W -
CLEAR -
ENTER - Second initialization command
B/W -

**GUIDE TO FEATURE PROGRAMMING**

MEMORY BLOCK BEING PROGRAMMED	MEMORY BLOCK THAT MUST BE PROGRAMMED	MEMORY BLOCK THAT MAY HAVE TO BE PROGRAMMED
3D2		

ALL CPU levels.

**NOTES:**

1. Depressing the ENTER key causes the system hardware to reset. Any traffic occurring at this time is released.
2. Make sure that all battery switches on the ETU's are turned on before performing a second initialization. Failure to do so may result in program loss.

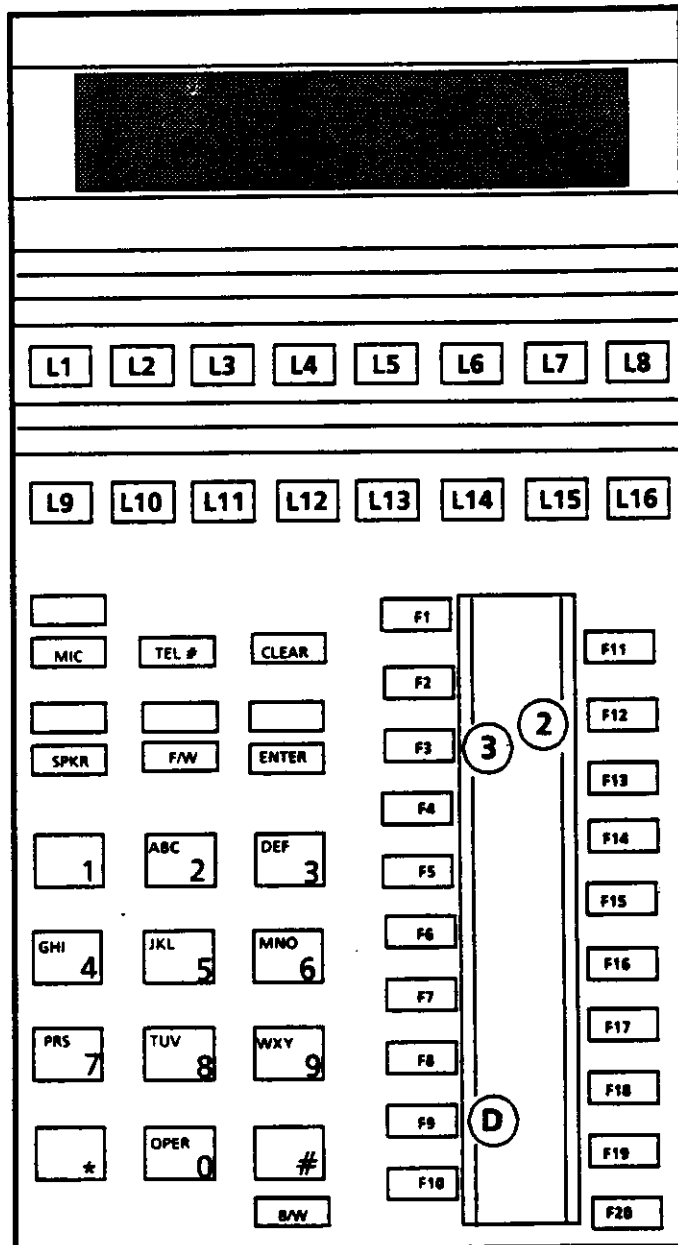

**GENERAL INFORMATION - SECOND INITIALIZATION**

This area of the memory block is used to reinitialize all system hardware. All system software and user programming is retained, after the second initialization.

## MEMORY BLOCK 3D3 - SLOT INITIALIZATION

OPERATION ← AND → DISPLAY

1. Go off line.

	O	F	F	-	L	I	N	E		(	X	.	X	X	)
	P	R	O	G	R	A	M		M	O	D	E			

2. Depress F3, then F9.

S	Y	S	.		I	N	I	T	I	A	L	I	Z	E	

3. Depress F13.

	S	L	O	T		I	N	I	T	I	A	L	I	Z	E
	M	O	D	U	L	E	?			S	L	O	T	*	

4. Dial module number (1~4) of the slot to be initialized.

Example: Module 1. (See Note 1).

	S	L	O	T		I	N	I	T	I	A	L	I	Z	E
	M	O	D	U	L	E	1			S	L	O	T	?	

5. Dial slot number (1~8) to be initialized.

Example: Slot 5. (See Note 1).

	S	L	O	T		I	N	I	T	I	A	L	I	Z	E
	M	O	D	U	L	E	1			S	L	O	T	5	

6. Depress ENTER key.

(1) When initialized

	S	L	O	T		I	N	I	T	I	A	L	I	Z	E
	M	O	D	U	L	E	?			S	L	O	T	*	

(2) When not initialized

	S	L	O	T		I	N	I	T	I	A	L	I	Z	E
	N	O	T		I	N	I	T	I	A	L	I	Z	E	D

7. Depress SPKR key to go back on line.

**KEY FUNCTION (OFF LINE)**

SPKR - ON/OFF Line
TEL # - Enters new module and slot number
F/W - Increments slot number
CLEAR -
ENTER - Enters each slot initialization
B/W - Decrements slot number

**GUIDE TO FEATURE PROGRAMMING**

MEMORY BLOCK BEING PROGRAMMED	MEMORY BLOCK THAT MUST BE PROGRAMMED	MEMORY BLOCK THAT MAY HAVE TO BE PROGRAMMED
3D3		

CPU-EB3 or higher.

**NOTES:**

1. During step 4 the status of L1 to L16 indicates the type of card assigned to the slot chosen. See figure below:

L1	L2	L3	L4	L5	L6	L7	L8
COI	TLI	SLI	MFR EA	NOT USED	CNF	NOT USED	VMI

L9	L10	L11	L12	L13	L14	L15	L16
ESI EA	ESI EB	ECR	NOT USED	NOT USED	NOT USED	NOT USED	NOT USED

**LED**

ON: Assigned  
 OFF: Not assigned

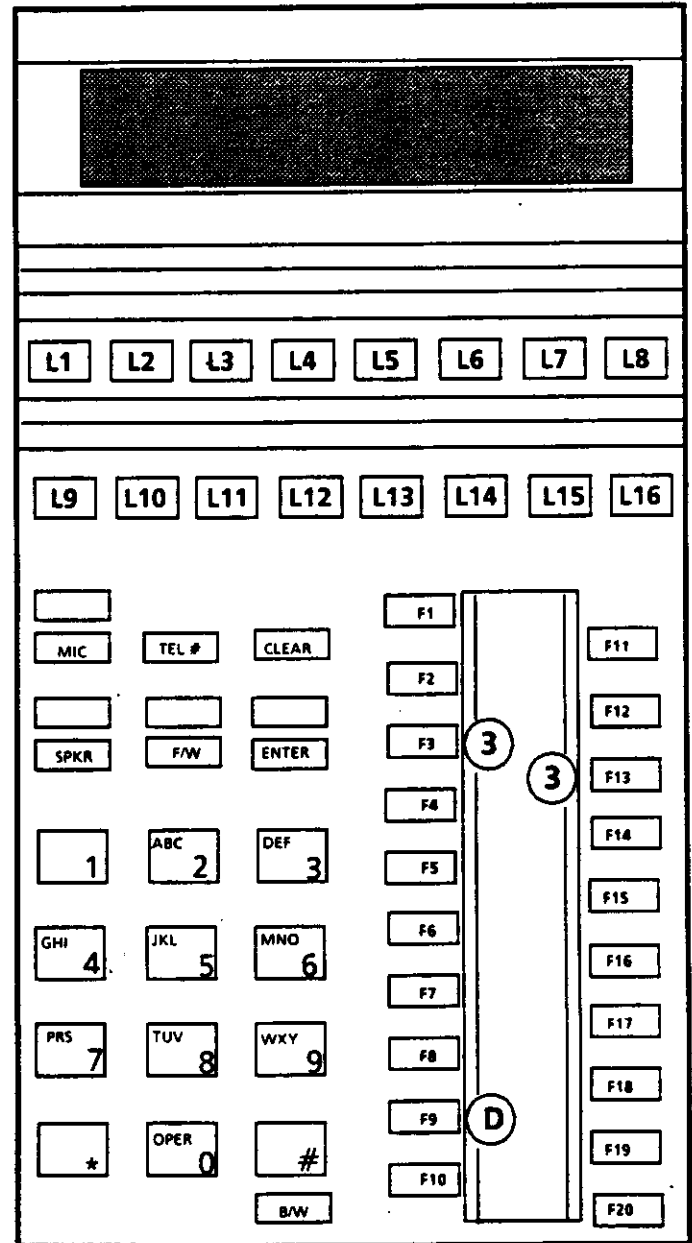

**GENERAL INFORMATION - SLOT INITIALIZATION**

This area of the memory block is used to initialize interface cards to the CCU interface slots.

### MEMORY BLOCK 3D4 - TERMINAL (TEL, DSS) INITIALIZATION

OPERATION   ←   AND   →   DISPLAY

1. Go off line.

	O	F	F	-	L	I	N	E		(	X	.	X	X	)
P	R	O	G	R	A	M		M	O	D	E				

2. Depress F3, then F9.

S	Y	S	.		I	N	I	T	I	A	L	I	Z	E	

3. Depress F14.

T	E	R	M	.		I	N	I	T	I	A	L	I	Z	E
T	E	L	?	?	?										

4. Dial station number to be initialized.  
 Example: Station 120.

T	E	R	M	.		I	N	I	T	I	A	L	I	Z	E
T	E	L	1	2	0										

5. Depress ENTER key. (See Note 2).

(1) When initialized

T	E	R	M	.		I	N	I	T	I	A	L	I	Z	E
T	E	L	?	?	?										

(2) When not initialized (See Note 3).

T	E	R	M	.		I	N	I	T	I	A	L	I	Z	E
N	O	T				I	N	I	T	I	A	L	I	Z	E

6. To access DSS/BLF area, depress L14.

T	E	R	M	.		I	N	I	T	I	A	L	I	Z	E
D	S	S	?												

7. Dial DSS/BLF number 1~6 to be initialized.  
 Example: DSS/BLF 2.

T	E	R	M	.		I	N	I	T	I	A	L	I	Z	E
D	S	S	2												

8. Depress ENTER key

(1) When initialized

T	E	R	M	.		I	N	I	T	I	A	L	I	Z	E
T	E	L	?	?	?										

(2) When not initialized (See Note 3).

T	E	R	M	.		I	N	I	T	I	A	L	I	Z	E
N	O	T				I	N	I	T	I	A	L	I	Z	E

9. }  
 10. } To access port area, depress L15.  
 11. }

T	E	R	M	.		I	N	I	T	I	A	L	I	Z	E
T	E	L	?	?	?										

12. Depress SPKR key to go back on line.

**KEY FUNCTION (OFF LINE)**

<b>SPKR</b> - ON/OFF Line
<b>TEL #</b> - Selects port/device number
<b>F/W</b> - Increments port/device number
<b>CLEAR</b> -
<b>ENTER</b> - Enters each port/device to be initialized
<b>B/W</b> - Decrements port/device number

**GUIDE TO FEATURE PROGRAMMING**

MEMORY BLOCK BEING PROGRAMMED	MEMORY BLOCK THAT MUST BE PROGRAMMED	MEMORY BLOCK THAT MAY HAVE TO BE PROGRAMMED
<b>3D4</b>		

CPU-EB3 or higher.

**NOTES:**

1. There are three terminal initialization modes: Station, DSS/BLF and Port. When entering Memory Block 3D4, the programming station will default to station initialization.
2. Depressing the ENTER key causes the particular station or DSS/BLF to be initialized.
3. If no initialization occurs due to abnormal conditions, the station or DSS/BLF should be disconnected and connected (by unplugging and plugging the line cord) or the associated ESI ETU should be initialized.

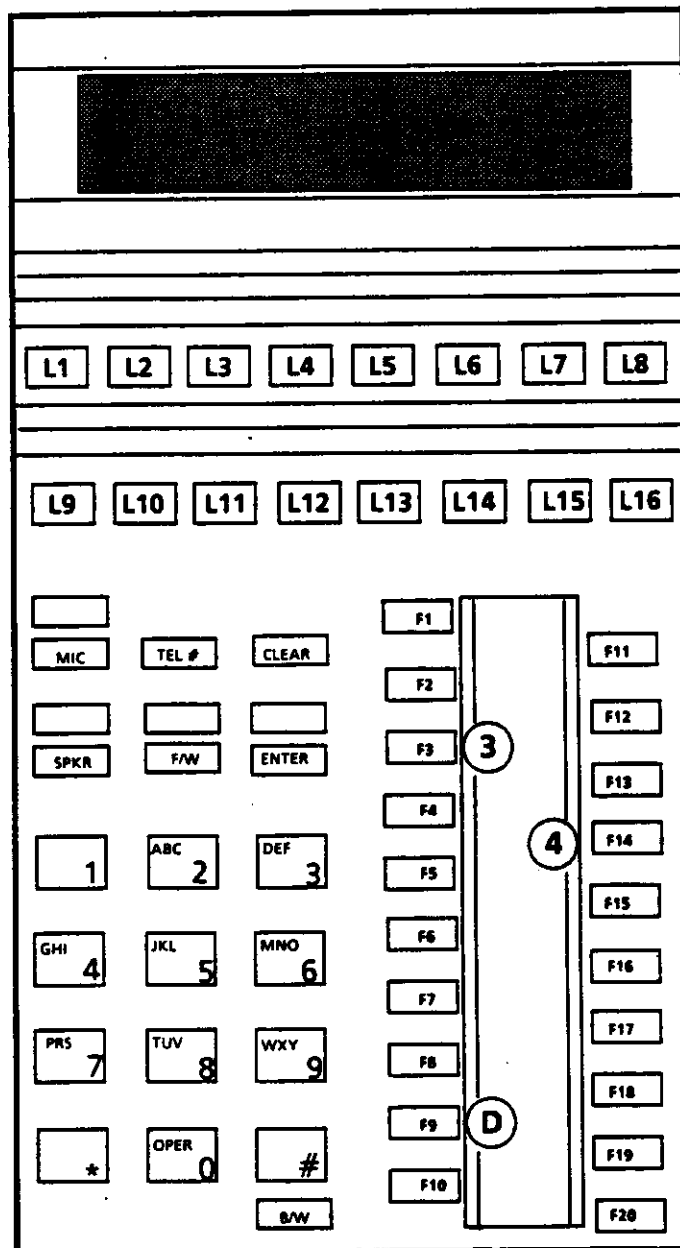

**GENERAL INFORMATION - TERMINAL (TEL, DSS) INITIALIZATION**

This area of the memory block is use to be initialize port devices including ESI-EA and ESI-EB ETUs. The port device can be indexed by port, station number or DSS/BLF device number only.

### MEMORY BLOCK 3E1 - REGIONAL DIALING ASSIGNMENT

OPERATION ← AND → DISPLAY

1. Go off line.

	O	F	F	-	L	I	N	E		(	X	.	X	X	)
	P	R	O	G	R	A	M		M	O	D	E			

2. Depress F3, then F10.

S	Y	S	.		R	E	S	T	.		T	A	B	L	E

3. Depress F11. (See Note 1).

	A	R	E	A		A	S	S	I	G	N				
X	X	X	X	X	X	X	X	X	X	X	X	X	X	X	X

4. Dial area number to be set (1~3).  
 Example: 1 Direct Dial. (See Note 2).

	A	R	E	A		A	S	S	I	G	N				
D	I	R	E	C	T		D	I	A	L					

5. Depress ENTER key.

6. Depress the SPKR key to go back on line.



**KEY FUNCTION (OFF LINE)**

SPKR - ON/OFF Line
TEL # -
F/W -
CLEAR -
ENTER - Enters area type
B/W -

**GUIDE TO FEATURE PROGRAMMING**

MEMORY BLOCK BEING PROGRAMMED	MEMORY BLOCK THAT MUST BE PROGRAMMED	MEMORY BLOCK THAT MAY HAVE TO BE PROGRAMMED
<b>3E1</b>		3E10

ALL CPU levels.

**NOTES:**

1. After step 3, the display will show the previous region assignment.
2. The following is a description of each area number that can be entered:

REGION NUMBER	DIALING TYPE
1	Direct Dial/1 + Dial
2	Independent Telephone Co.
3	Puerto Rico (Type) Dialing

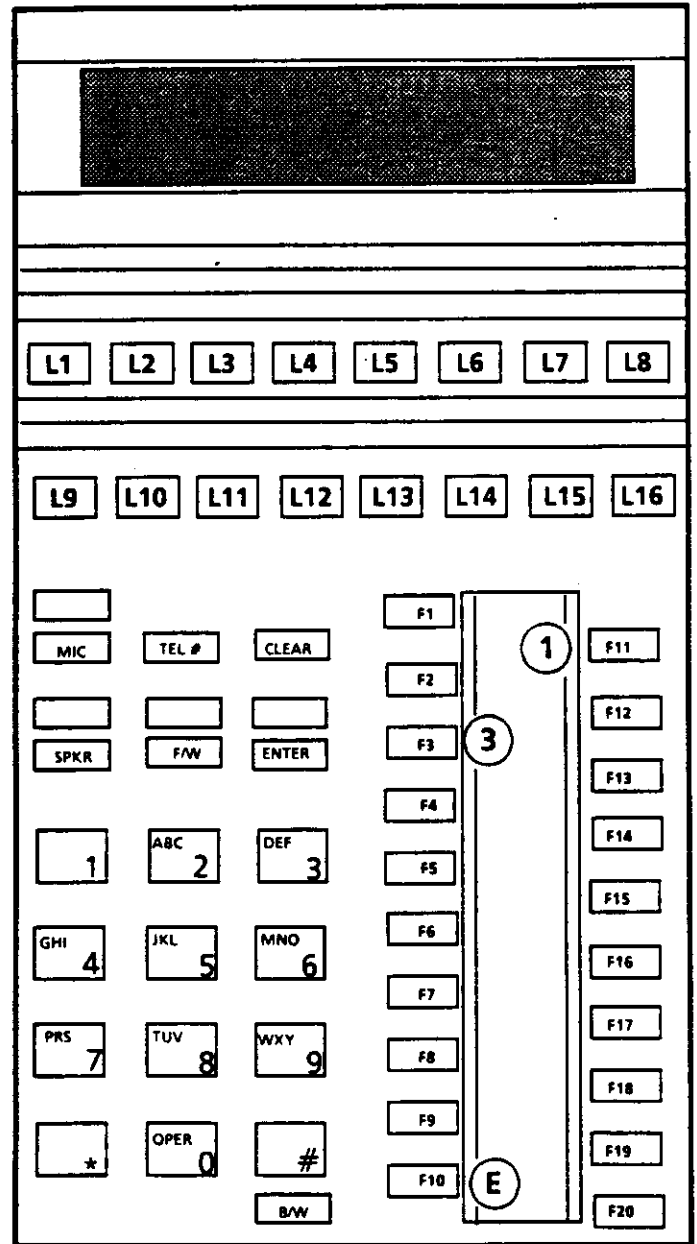

**GENERAL INFORMATION - REGIONAL DIALING ASSIGNMENT**

This area of the memory block is used to designate the type of dialing area, where the system is installed. This information is important when applying code restrictions to stations.

**MEMORY BLOCK 3E2 - 1+ DIALING ASSIGNMENT**

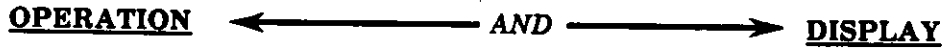

1. Go off line.

	O	F	F	-	L	I	N	E		(	X	.	X	X	)
	P	R	O	G	R	A	M		M	O	D	E			

2. Depress F3, then F10.

S	Y	S	.		R	E	S	T	.		T	A	B	L	E

3. Depress F12.

D	I	R	E	C	T	/	1	+	D	I	A	L			

4. Depress L1 to L8 to assign 1+ or direct dial to each Trunk Group. (See Note 1).
5. Depress ENTER key.
6. Depress the SPKR key to go back on line.

**KEY FUNCTION (OFF LINE)**

SPKR - ON/OFF Line
TEL # -
F/W -
CLEAR -
ENTER - Enters assignment
B/W -

**GUIDE TO FEATURE PROGRAMMING**

MEMORY BLOCK BEING PROGRAMMED	MEMORY BLOCK THAT MUST BE PROGRAMMED	MEMORY BLOCK THAT MAY HAVE TO BE PROGRAMMED
3E2	2C1	

All CPU levels.

**NOTES:**

- L1 to L8 correspond to Trunk Groups 1 to 8 respectively.

Line key LED **ON** = 1 + dial area  
**OFF** = direct dial

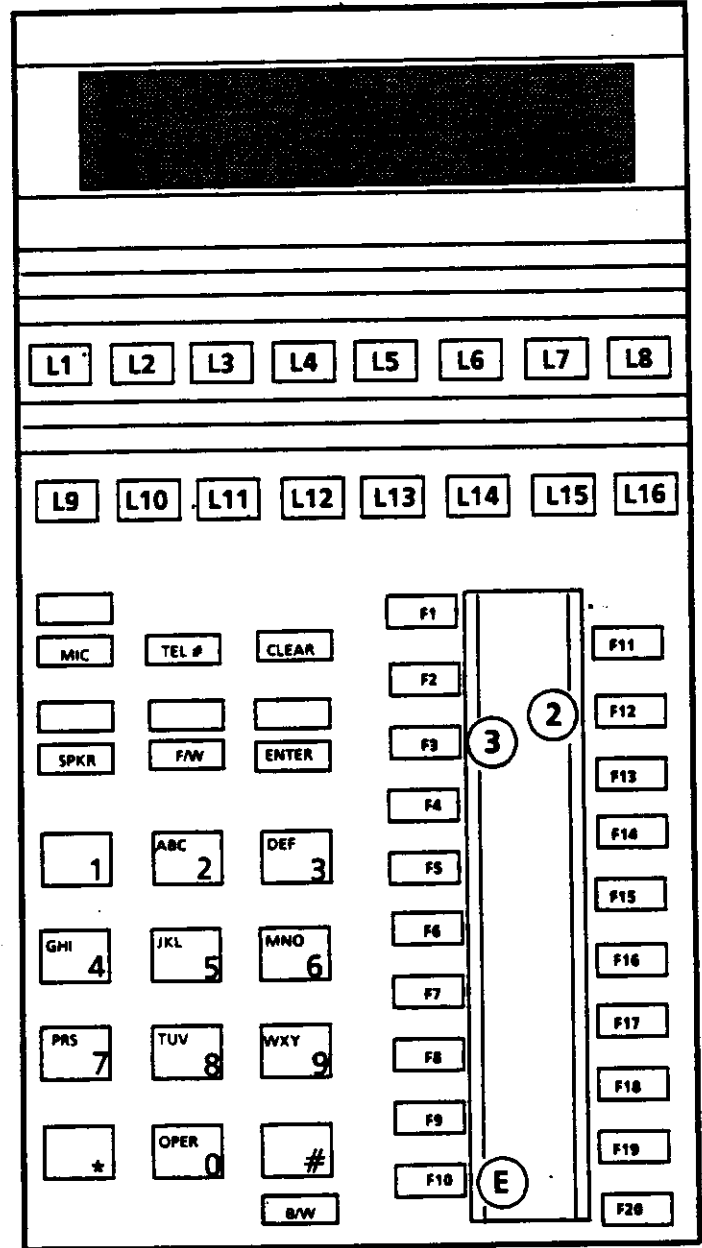

**GENERAL INFORMATION - 1 + DIALING ASSIGNMENT**

This area of the memory block is used to designate whether 1 + dialing and/or direct dialing service is required on the CO lines installed. This designation is assigned on a Trunk Group basis.

## MEMORY BLOCK 3E3 - REJECTION CODE ASSIGNMENT

OPERATION ← AND → DISPLAY

1. Go off line.

	O	F	F	-	L	I	N	E		(	X	.	X	X	)
	P	R	O	G	R	A	M		M	O	D	E			

2. Depress F3, then F10.

S	Y	S	.		R	E	S	T	.		T	A	B	L	E

3. Depress F13. (See Note 1).

R	E	J	E	C	T	.	C	O	D	E		A	S	G	N
C	O	D	E	1		-		?							

4. Dial single digit rejection code (2 ~ 9).  
 Example: 2, assigns the first rejection code.  
 (See Note 3).

R	E	J	E	C	T	.	C	O	D	E		A	S	G	N
C	O	D	E	1		-		2							

5. Depress ENTER key. (See Note 2).

R	E	J	E	C	T	.	C	O	D	E		A	S	G	N
C	O	D	E	2		-		X							

7. Repeat steps 4 and 5 for any additional rejection codes required.

8. Depress the SPKR key to go back on line.

**KEY FUNCTION (OFF LINE)**

<b>SPKR</b> - ON/OFF Line
<b>TEL #</b> - Selects code ONE
<b>F/W</b> - Increments to next code
<b>CLEAR</b> - Deletes rejection code
<b>ENTER</b> - Enters rejection code
<b>B/W</b> - Decrements to current code

**GUIDE TO FEATURE PROGRAMMING**

MEMORY BLOCK BEING PROGRAMMED	MEMORY BLOCK THAT MUST BE PROGRAMMED	MEMORY BLOCK THAT MAY HAVE TO BE PROGRAMMED
<b>3E3</b>		

All CPU levels.

**NOTES:**

1. During step 3 the display shows any current entry for code 1.
2. Depressing the ENTER key causes the display to increment to the next entry location.
3. Up to four single digit rejection codes can be assigned.

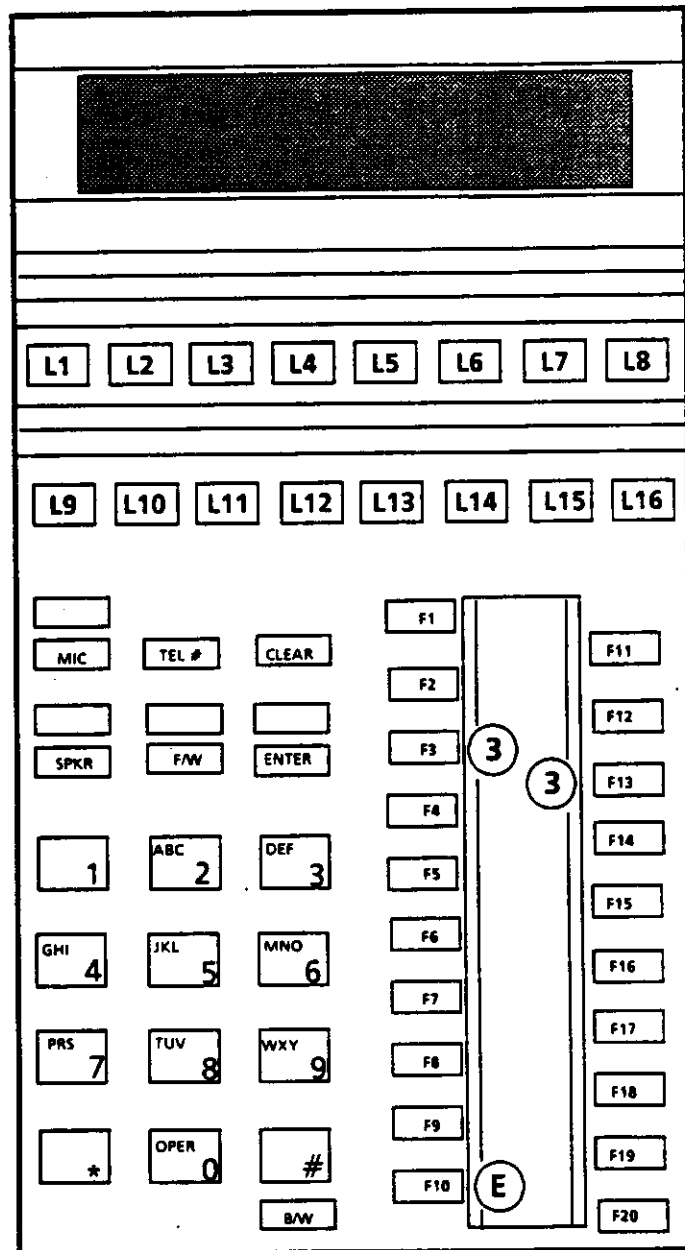

**GENERAL INFORMATION - REJECTION CODE ASSIGNMENT**

This area of the memory block is used to assign up to 4 single digit Rejection Codes. The Rejection Code is used to prevent a code restricted station from by-passing the dialing restriction by first dialing out a sequence of single digits.

**MEMORY BLOCK 3E4 - SYSTEM ALLOW/DENY ASSIGNMENT**

OPERATION ← AND → DISPLAY

1. Go off line.

	O	F	F	-	L	I	N	E		(	X	.	X	X	)
	P	R	O	G	R	A	M		M	O	D	E			

2. Depress F3, then F10.

S	Y	S	.		R	E	S	T	.		T	A	B	L	E

3. Depress F14. (See Note 1).

S	Y	S	.		A	L	L	O	W	/	D	E	N	Y	

4. Depress L1 to Allow or Deny.
5. Depress ENTER key.
6. Depress the SPKR key to go back on line.

**KEY FUNCTION (OFF LINE)**

SPKR - ON/OFF Line
TEL # -
F/W -
CLEAR -
ENTER - Enters allow/deny option
B/W -

**GUIDE TO FEATURE PROGRAMMING**

MEMORY BLOCK BEING PROGRAMMED	MEMORY BLOCK THAT MUST BE PROGRAMMED	MEMORY BLOCK THAT MAY HAVE TO BE PROGRAMMED
<b>3E4</b>		

All CPU levels.

**NOTES:**

1. During step 3 the indication on line key L1 shows the previous assignment.

L1 On= Allow  
 Off= Deny

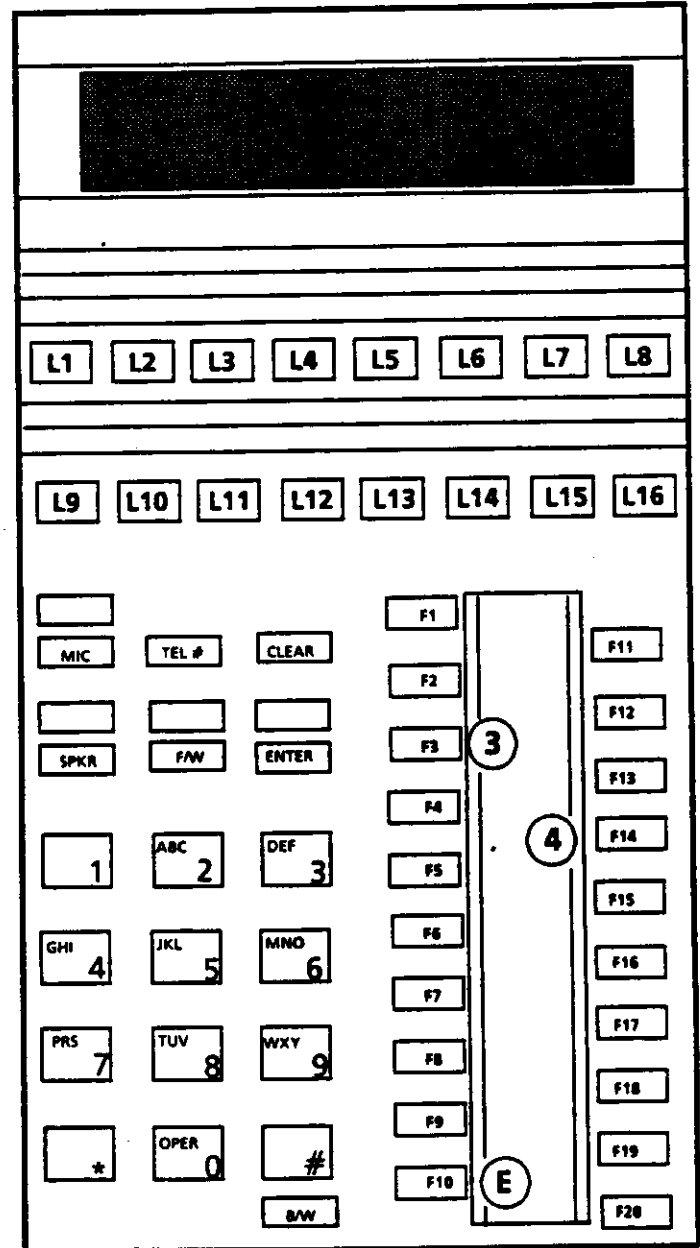

**GENERAL INFORMATION - SYSTEM ALLOW/DENY ASSIGNMENT**

This area of the memory block is used to decide, system wide, whether code restricted stations are allowed or denied to dial numbers that do not match the codes entered in the assigned code tables.

**MEMORY BLOCK 3E5 - TABLE ALLOW/DENY**

OPERATION ← AND → DISPLAY

1. Go off line.

	O	F	F	-	L	I	N	E		(	X	.	X	X	)
	P	R	O	G	R	A	M		M	O	D	E			

2. Depress F3, then F10.

S	Y	S	.		R	E	S	T	.		T	A	B	L	E

3. Depress F15.

A	L	L	O	W	/	D	E	N	Y						
T	A	B	L	E	?	?									

4. Dial table number to be set (01 ~ 32). Example:  
 Table number 14. (See Note 1).

A	L	L	O	W	/	D	E	N	Y		T	B	L	1	4

5. Depress L1 to allow or deny table chosen.

6. Depress ENTER key. (See Note 2).

A	L	L	O	W	/	D	E	N	Y		T	B	L	1	5

7. Repeat steps 5 and 6 for all subsequent tables required or go to step 3 to select a particular table.

8. Depress the SPKR key to go back on line.



**KEY FUNCTION (OFF LINE)**

SPKR - ON/OFF Line
TEL # - Enters new table number
F/W - Increments table number
CLEAR -
ENTER - Enters allow/deny option
B/W - Decrements table number

**GUIDE TO FEATURE PROGRAMMING**

MEMORY BLOCK BEING PROGRAMMED	MEMORY BLOCK THAT MUST BE PROGRAMMED	MEMORY BLOCK THAT MAY HAVE TO BE PROGRAMMED
3E5	3E6, 3E9	3E7, 3E8

All CPU levels.

**NOTES:**

- During step 4 the LED indication on L1 indicates the previous assignment for the table chosen.  
 L1 LED On = Allow Table  
 Off = Deny Table
- Depressing the ENTER key causes the display to increment to the next table.

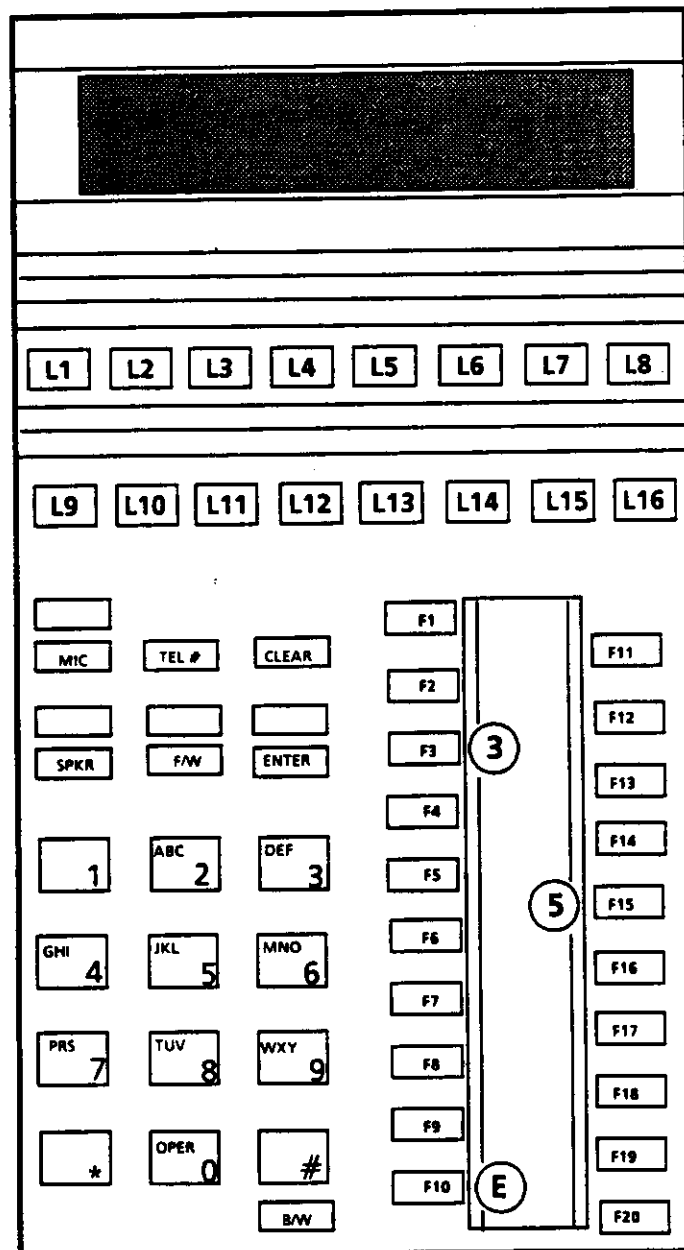

**GENERAL INFORMATION - TABLE ALLOW/DENY**

This memory block area of the program is used to individually assign each of the 32 code restriction tables as either allow or deny tables.

**MEMORY BLOCK 3E6 - TRUNK GROUP TO CODE TABLE ASSIGNMENT**

OPERATION ← AND → DISPLAY

1. Go off line.

	O	F	F	-	L	I	N	E		(	X	.	X	X	)
	P	R	O	G	R	A	M		M	O	D	E			

2. Depress F3, then F10.

S	Y	S	.		R	E	S	T	.		T	A	B	L	E

3. Depress F16.

	T	R	U	N	K		G	-	T	A	B	L	E		
T	A	B	L	E	?	?									

4. Dial table number to be set (01 ~ 32).  
 Example: Table number 14. (See Note 1).

	T	R	K	.		G	-	T	B	L		T	B	L	1	4

5. Depress up to four line keys L1 to L8 to assign the appropriate Trunk Groups for the table chosen.  
 (See Note 2).

6. Depress ENTER key. (See Note 3).

	T	R	K	.		G	-	T	B	L		T	B	L	1	5

7. Repeat steps 5 and 6 for all subsequent tables required or go to step 3 to select a particular table.

8. Depress the SPKR key to go back on line.

**KEY FUNCTION (OFF LINE)**

<b>SPKR</b> - ON/OFF Line
<b>TEL #</b> - Enters new table number
<b>F/W</b> - Increments table number
<b>CLEAR</b> -
<b>ENTER</b> - Enters each table assignment
<b>B/W</b> - Decrements table number

**GUIDE TO FEATURE PROGRAMMING**

MEMORY BLOCK BEING PROGRAMMED	MEMORY BLOCK THAT MUST BE PROGRAMMED	MEMORY BLOCK THAT MAY HAVE TO BE PROGRAMMED
<b>3E6</b>	3E5, 3E9	2C1, 2C3
		3E7, 3E8

All CPU levels.

**NOTES:**

1. During step 4 the line key LED indication displays the trunk groups previously assigned to the table chosen. L1 to L8 correspond to trunk groups 1 to 8 respectively.

LED On = Assigned  
 Off = Not Assigned

2. A maximum of 4 Trunk Groups can be assigned to each table.
3. Depressing the ENTER key causes the display to increment to the next table.

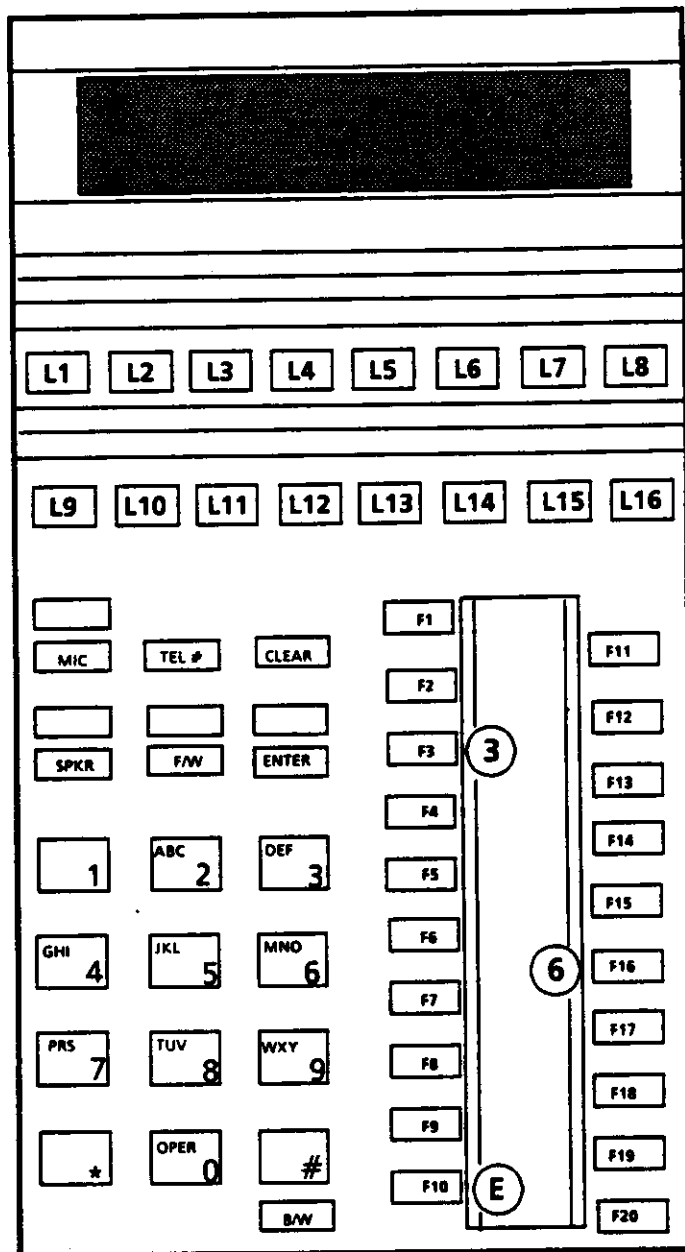

**GENERAL INFORMATION - TRUNK GROUP TO CODE TABLE ASSIGNMENT**

This memory block area of the program is used to assign Trunk Groups to code restriction tables. Up to four trunk groups can be assigned to each table.

**MEMORY BLOCK 3E7 - TABLE OCC FLAG ASSIGNMENT**

OPERATION ← AND → DISPLAY

1. Go off line.

	O	F	F	-	L	I	N	E		(	X	.	X	X	)
	P	R	O	G	R	A	M		M	O	D	E			

2. Depress F3, then F10.

S	Y	S	.		R	E	S	T	.		T	A	B	L	E

3. Depress F17.

	O	C	C		F	L	A	G							
T	A	B	L	E	?	?									

4. Dial table number to be set (01 ~ 32).  
 Example: Table number 14. (See Note 1).

	O	C	C		F	L	A	G		T	B	L	1	4	

5. Depress L1 to set or not set OCC flag to table chosen.

6. Depress ENTER key. (See Note 2).

	O	C	C		F	L	A	G		T	B	L	1	5	

7. Repeat steps 5 and 6 for all subsequent tables required or go to step 3 to select a particular table.

8. Depress the SPKR key to go back on line.

**KEY FUNCTION (OFF LINE)**

<b>SPKR</b> - ON/OFF Line
<b>TEL #</b> - Enters new table number
<b>F/W</b> - Increments table number
<b>CLEAR</b> -
<b>ENTER</b> - Enters each table assignment
<b>B/W</b> - Decrements table number

**GUIDE TO FEATURE PROGRAMMING**

MEMORY BLOCK BEING PROGRAMMED	MEMORY BLOCK THAT MUST BE PROGRAMMED	MEMORY BLOCK THAT MAY HAVE TO BE PROGRAMMED
<b>3E7</b>	<b>3E8</b>	

All CPU levels.

**NOTES:**

1. During step 4 L1 LED displays whether the OCC flag had previously been set to the table chosen.

L1 LED On = OCC flag set  
 Off = OCC flag not set

2. Depressing the ENTER key causes the display to increment to the next table.

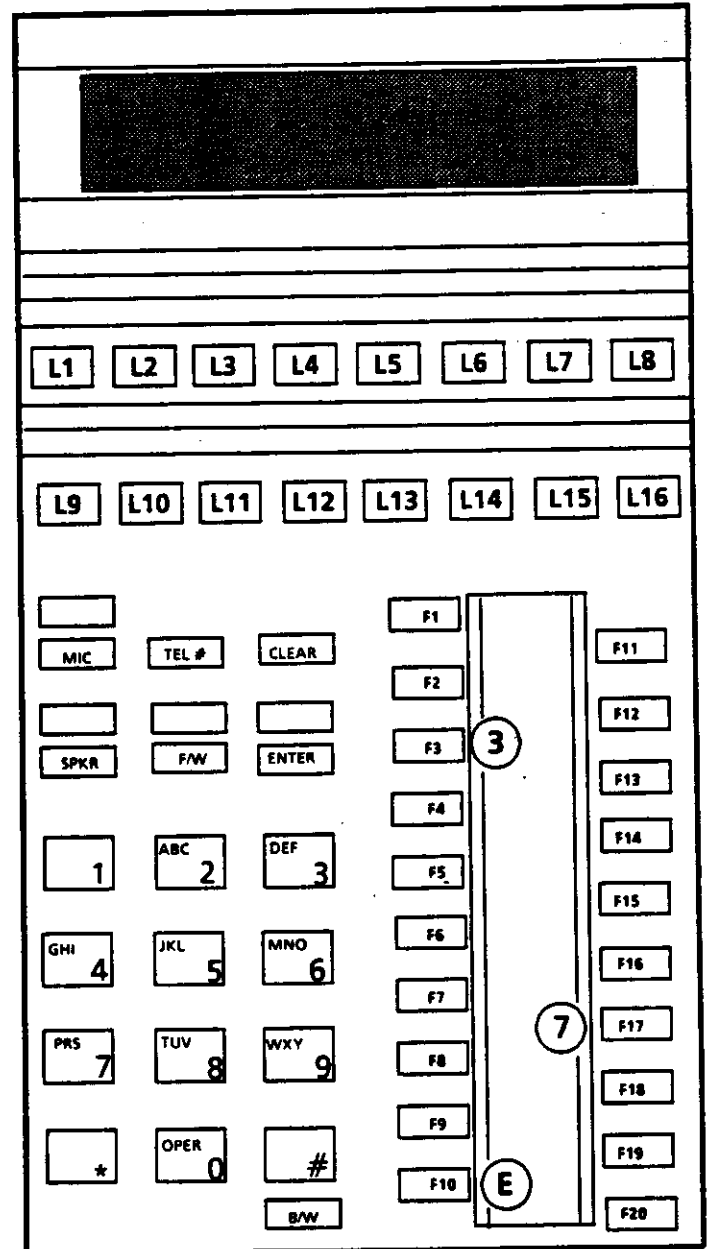

**GENERAL INFORMATION - TABLE OCC FLAG ASSIGNMENT**

This memory block area of the program is used to assign an OCC flag to each table. All stations assigned restriction tables that have the OCC flag set are allowed, or denied, to dial the common carriers, which are specified in memory block 3E8.

### MEMORY BLOCK 3E8 - TABLE OCC CODE ASSIGNMENT

OPERATION ← AND → DISPLAY

1. Go off line.
 

	O	F	F	-	L	I	N	E		(	X	.	X	X	)
	P	R	O	G	R	A	M		M	O	D	E			
  
2. Depress F3, then F10.
 

S	Y	S	.		R	E	S	T	.		T	A	B	L	E
  
3. Depress F18.
 

	O	C	C		C	O	D	E							
T	A	B	L	E	?	?									
  
4. Dial table number to be set (01 ~ 32).  
 Example: Table number 14. (See Note 1).
 

	O	C	C		C	O	D	E		T	B	L	1	4	
C	O	D	E	1		-		1	0	?	?	?			
  
5. Dial last three digits of OCC code to be entered.  
 Example: 233.
 

	O	C	C		C	O	D	E		T	B	L	1	4	
C	O	D	E	1		-		1	0	2	3	3			
  
6. Depress ENTER key. (See Notes 2 and 4).
 

	O	C	C		C	O	D	E		T	B	L	1	4	
C	O	D	E	2		-		1	0	?	?	?			
  
7. Repeat steps 5 and 6 for the second code to be entered at the chosen table. (See Note 3).
  
8. Depress TEL # key and repeat steps 4 to 7 for all additional tables required.
 

	O	C	C		C	O	D	E							
T	A	B	L	E	?	?									
  
9. Depress SPKR key to go back on line.

**KEY FUNCTION (OFF LINE)**

SPKR - ON/OFF Line
TEL # - Enters new table number
F/W - Increments table number
CLEAR - Clears OCC code
ENTER - Enters each OCC code
B/W - Decrements table number

**GUIDE TO FEATURE PROGRAMMING**

MEMORY BLOCK BEING PROGRAMMED	MEMORY BLOCK THAT MUST BE PROGRAMMED	MEMORY BLOCK THAT MAY HAVE TO BE PROGRAMMED
3E8	3E7	

All CPU levels.

**NOTES:**

1. During step 4 the display may show a previous OCC code set to code 1 of the table chosen.
2. Depressing the ENTER key causes the display to increment to the next code number.
3. Up to 2 OCC codes can be set in each code table.
4. During step 6 the display may show any current OCC code set to code 2 of the table chosen.

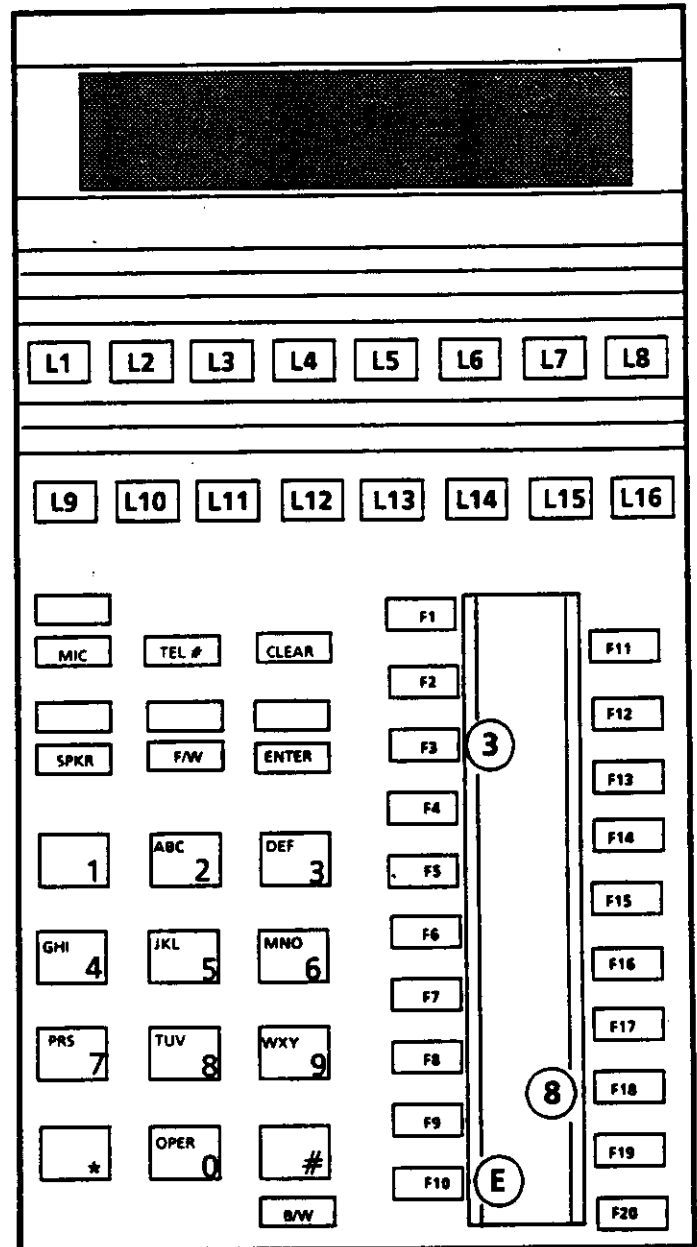

**GENERAL INFORMATION - TABLE OCC CODE ASSIGNMENT**

This area of the memory block is used to assign a maximum of 2 OCC codes to each code table. This can force code restricted stations that are assigned tables with OCC codes to dial long distance calls on less expensive carriers.

**MEMORY BLOCK 3E9 - RESTRICTION TABLE CODE ASSIGNMENT.**

OPERATION ← AND → DISPLAY

1. Go off line.
 

	O	F	F	-	L	I	N	E		(	X	.	X	X	)	
	P	R	O	G	R	A	M		M	O	D	E				
  
2. Depress F3, then F10.
 

S	Y	S	.		R	E	S	T	.		T	A	B	L	E	
  
3. Depress F19.
 

	C	O	D	E		A	S	G	N							
T	A	B	L	E	?	?										
  
4. Dial table number to be assigned (01 ~ 32).
 

	C	O	D	E		A	S	G	N		T	B	L	1	4	
C	O	D	E	?												
  
5. Enter code number to be set (1 ~ 8).  
 Example: Code number 5. (See Notes 1 and 2).
 

	C	O	D	E		A	S	G	N		T	B	L	1	4	
C	O	D	E	5	-		A	X	X	X	O	Y	Y	Y		
  
6. Dial area code to be set.  
 Example : Area code 516.
 

	C	O	D	E		A	S	G	N		T	B	L	1	4	
C	O	D	E	5	-		A	5	1	6	O	Y	Y	Y		
  
7. Dial office code to be set.  
 Example : Office code 777.
 

	C	O	D	E		A	S	G	N		T	B	L	1	4	
C	O	D	E	5	-		A	5	1	6	O	7	7	7		
  
8. Depress ENTER key. (See Note 3).
 

	C	O	D	E		A	S	G	N		T	B	L	1	4	
C	O	D	E	6	-		A	X	X	X	O	Y	Y	Y		
  
9. Repeat steps 6 to 8 for all code numbers in the table as required. (See Notes 4 and 5).
  
10. Depress TEL # key and repeat steps 4 to 8  
 for all tables required.
 

	C	O	D	E		A	S	G	N							
T	A	B	L	E	?	?										
  
11. Depress the SPKR key to go back on line.



**KEY FUNCTION (OFF LINE)**

<b>SPKR</b> - ON/OFF Line
<b>TEL #</b> - Enters new table number
<b>F/W</b> - Increments table number
<b>CLEAR</b> - Clears code
<b>ENTER</b> - Enters each code
<b>B/W</b> - Decrements table number

**GUIDE TO FEATURE PROGRAMMING**

MEMORY BLOCK BEING PROGRAMMED	MEMORY BLOCK THAT MUST BE PROGRAMMED	MEMORY BLOCK THAT MAY HAVE TO BE PROGRAMMED
<b>3E9</b>	3E5, 3E6	3E7, 3E8

All CPU levels.

**NOTES:**

1. During step 4 the display shows any current area and office code assigned to the code number and table chosen.
2. Each table can have a maximum of 8 code numbers (entries).
3. Depressing the ENTER key causes the display to increment to the next code number in the table.
4. The \* key is used to enter three \*'s in the area and/or office code positions. These three \*'s represent any digits dialed, from 1 ~ 0, \*, and #.
5. The # key is used to enter blanks in the office and area code position areas. (Blanks (-) are shown in the corresponding positions).
6. Any time an area code is programmed, blanks must not be left in the office code position.

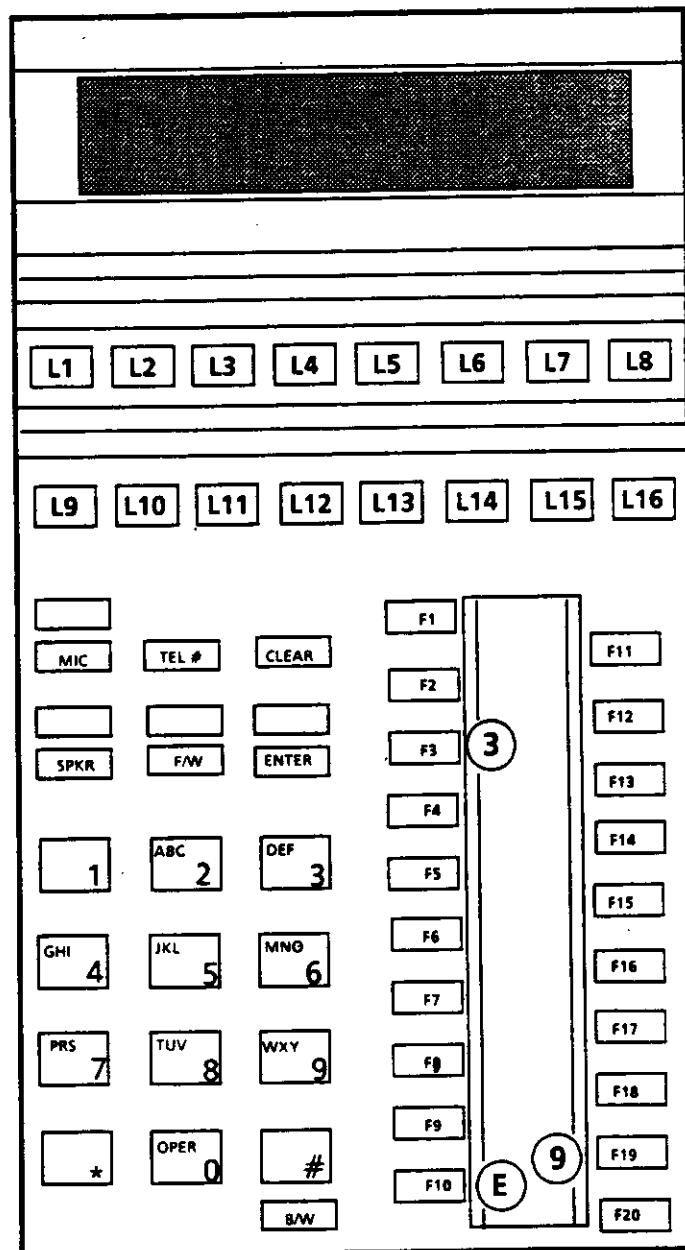

**GENERAL INFORMATION - RESTRICTION TABLE CODE ASSIGNMENT**

This area of the memory block is used to program area and office codes into the system code restriction tables. There are 32 code tables available and each table can hold up to 8 area and office codes.

### MEMORY BLOCK 3E10 - SPECIAL CODE ASSIGNMENT

OPERATION ← AND → DISPLAY

1. Go off line.

	O	F	F	-	L	I	N	E		(	X	.	X	X	)
	P	R	O	G	R	A	M		M	O	D	E			

2. Depress F3, then F10.

S	Y	S	.		R	E	S	T	.		T	A	B	L	E

3. Depress F20. (See Note 1).

	S	P	E	C	I	A	L		C	.		A	S	G	N
C	O	D	E	1		-		?	?	?					

4. Dial code number to be set.  
 Example: Code number 144.

	S	P	E	C	I	A	L		C	.		A	S	G	N
C	O	D	E	1		-		1	4	4					

5. Depress ENTER key. (See Notes 2 and 3).

	S	P	E	C	I	A	L		C	.		A	S	G	N
C	O	D	E	2		-		?	?	?					

6. Repeat steps 4 and 5 for each subsequent special code required.

7. Depress SPKR key to go back on line.

**KEY FUNCTION (OFF LINE)**

<b>SPKR</b> - ON/OFF Line
<b>TEL #</b> - Returns display to code 1
<b>F/W</b> - Increments code number
<b>CLEAR</b> - Delete special code assigned
<b>ENTER</b> - Enters each code
<b>B/W</b> - Decrements code number

**GUIDE TO FEATURE PROGRAMMING**

MEMORY BLOCK BEING PROGRAMMED	MEMORY BLOCK THAT MUST BE PROGRAMMED	MEMORY BLOCK THAT MAY HAVE TO BE PROGRAMMED
<b>3E10</b>	<b>3E1</b>	

All CPU levels.

**NOTES:**

1. During step 3 the display shows any current Special Code entry in the first code location.
2. Depressing the ENTER key causes the display to increment to the next code location. Up to 8 Special Codes can be entered.
3. When the (Puerto Rico) Special Code is assigned in the area assignment, code table 32 becomes the Special Code table.

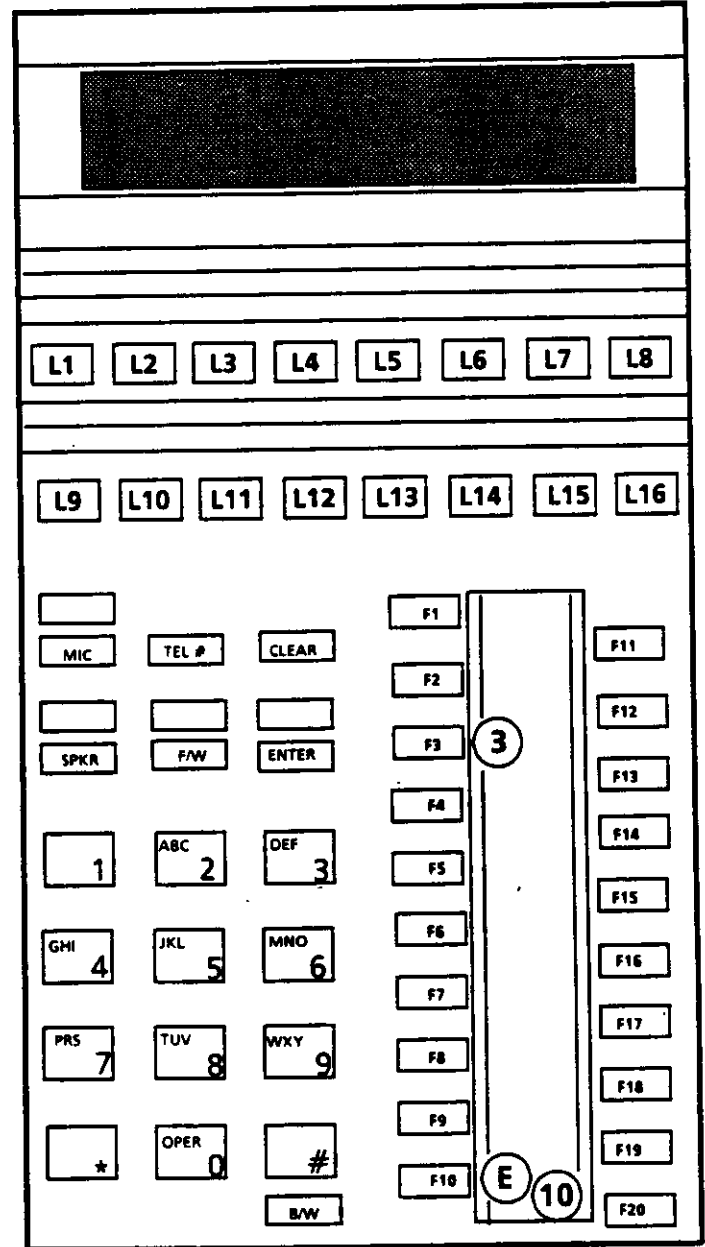

**GENERAL INFORMATION - SPECIAL CODE ASSIGNMENT**

This area of the memory block is used to enter Special Codes into a table. This table is used only when the system area is programmed for the Puerto Rico area in memory block 3E1.

**MEMORY BLOCK 4A1 - SYSTEM ALL BUSY RESTORE ASSIGNMENT**

OPERATION ← AND → DISPLAY

1. Go off line.

	O	F	F	-	L	I	N	E		(	X	.	X	X	)
	P	R	O	G	R	A	M		M	O	D	E			

2. Depress F4.

C	A	R	D												

3. Depress F6.

S	Y	S	T	E	M		A	L	L		B	U	S	Y	

4. Depress F11. (See Note 1).

S	Y	S	T	E	M		R	E	S	T	O	R	E		

5. If no change in the system status is required, go to step 6.

6. Depress ENTER key to restore the system.

7. Depress SPKR key to go back on line.

**KEY FUNCTION (OFF LINE)**

SPKR - ON/OFF Line
TEL # -
F/W -
CLEAR -
ENTER - Enters busy in system
B/W -

**GUIDE TO FEATURE PROGRAMMING**

MEMORY BLOCK BEING PROGRAMMED	MEMORY BLOCK THAT MUST BE PROGRAMMED	MEMORY BLOCK THAT MAY HAVE TO BE PROGRAMMED
4A1		4A2

All CPU levels.

**NOTES:**

1. During step 3 the status of line key L1 indicates if the system is busied out.

L1 ON = System busied out  
 OFF = System not busied out

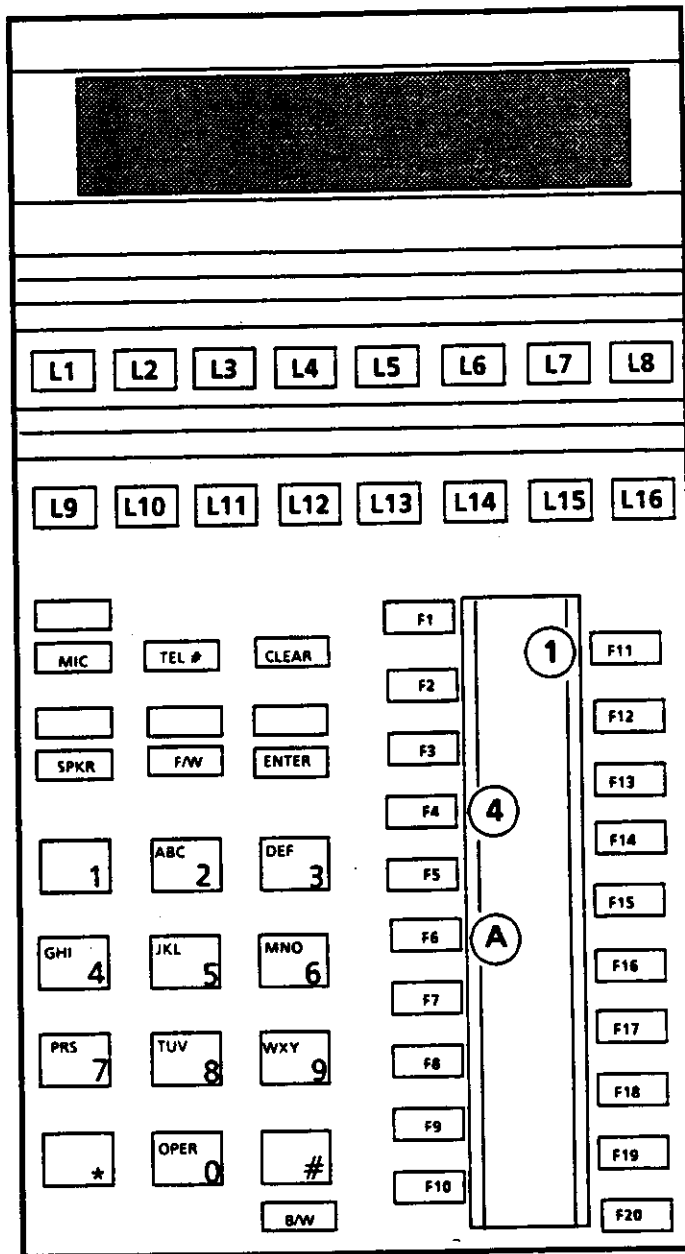

**GENERAL INFORMATION - SYSTEM ALL BUSY RESTORE ASSIGNMENT**

This area of the memory block is used to *restore* a system that is busied out. During a busy out condition, the system does not provide any call processing. Programming station is able to enter program mode during a system busy out condition.

### MEMORY BLOCK 4A2 - SYSTEM ALL BUSY OUT ASSIGNMENT

OPERATION      ← AND →      DISPLAY

1. Go off line.

	O	F	F	-	L	I	N	E		(	X	.	X	X	)
	P	R	O	G	R	A	M		M	O	D	E			

2. Depress F4, then F6.

S	Y	S	T	E	M		A	L	L		B	U	S	Y	

3. Depress F12. (See Note 1).

S	Y	S	T	E	M		B	U	S	Y		O	U	T	

4. If no change in the system status is required, go to step 6.

5. Depress ENTER key to Busy Out the system.

6. Depress SPKR key to go back on line.

**KEY FUNCTION (OFF LINE)**

SPKR - ON/OFF Line
TEL # -
F/W -
CLEAR -
ENTER - To busy out
B/W -

**GUIDE TO FEATURE PROGRAMMING**

MEMORY BLOCK BEING PROGRAMMED	MEMORY BLOCK THAT MUST BE PROGRAMMED	MEMORY BLOCK THAT MAY HAVE TO BE PROGRAMMED
<b>4A2</b>		4A1

All CPU levels.

**NOTES:**

1. During step 3 the status of line key L1 indicates if the system is busied out.

L1 ON = System busied out  
 OFF = System not busied out

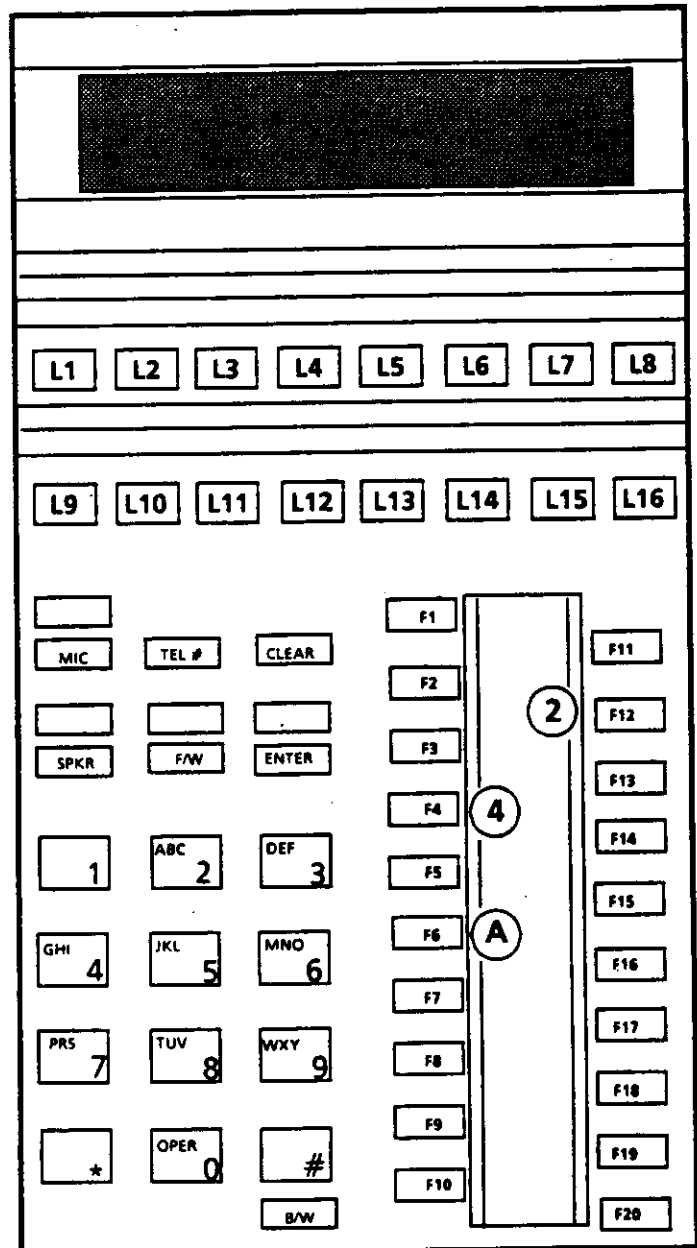

**GENERAL INFORMATION - SYSTEM ALL BUSY OUT ASSIGNMENT**

This area of the memory block is used to busy out a system. During a Busy Out condition, the system does not provide any call processing.

**MEMORY BLOCK 4B1 - COI-I INITIALIZED VALUES**

**OPERATION** ← AND → **DISPLAY**

1. Go off line.

O	F	F	-	L	I	N	E		(	X	.	X	X	)
P	R	O	G	R	A	M	M	O	D	E				

2. Depress F4, then F7.

C	A	R	D		M	O	D	E						

3. Depress F11. (See Note 1).

C	O	I		I	N	I	T	I	A	L	I	Z	E	1
M	O	D	?		S	L	O	T	*		C	H	*	

4. Dial CCU module number (1 ~ 4) where COI port is to be programmed. Example: Module 1.

C	O	I		I	N	I	T	I	A	L	I	Z	E	1
M	O	D	1		S	L	O	T	?		C	H	*	

5. Dial CCU slot number (1 ~ 8) where COI port is to be programmed. Example: Slot 2.

C	O	I		I	N	I	T	I	A	L	I	Z	E	1
M	O	D	1		S	L	O	T	2		C	H	?	

6. Dial COI channel number (1 ~ 4) of COI port to be assigned. Example: Channel 1. (See Note 2).

C	O	I		I	N	I	T	I	A	L	I	Z	E	1
M	O	D	1		S	L	O	T	2		C	H	1	

7. Depress L1 to L12 to set the desired parameters of the COI port. Corresponding LED(s) turn on or off accordingly.

8. Depress ENTER key. (See Note 3).

C	O	I		I	N	I	T	I	A	L	I	Z	E	1
M	O	D	1		S	L	O	T	2		C	H	2	

9. Repeat steps 7 and 8 for all additional COI ports as required or go to step 3 to select a particular COI port.

10. Depress the SPKR key to go back on line.



**KEY FUNCTION (OFF LINE)**

SPKR - ON/OFF Line
TEL # - Selects COI port number
F/W - Increments channel number
CLEAR -
ENTER - Enters each assignment
B/W - Decrements channel number

**GUIDE TO FEATURE PROGRAMMING**

MEMORY BLOCK BEING PROGRAMMED	MEMORY BLOCK THAT MUST BE PROGRAMMED	MEMORY BLOCK THAT MAY HAVE TO BE PROGRAMMED
<b>4B1</b>		4B2, 4B6, 4B7

All CPU levels (See L4 in Note 2).

**NOTES:**

- It is recommended that 4B6 be programmed prior to 4B1, since 4B6 programming overrides all 4B1 programming already done for all the trunks in the group.
- During step 6, the status of L1 to L12 LEDs indicate the current parameters set to the COI channel chosen. See figure below.
  - L1 = 10 or 20 PPS for rotary dialing (Default: 10 PPS)
  - L2 = Rotary or DTMF dialing (Default: DTMF)
  - L3 = CO or PBX line interface (Default: CO)
  - L4 = Disconnect Signal from CO (YES/NO) (Default: NO) (CPU-EB2 or higher)
  - L5 to L8 = DTMF digit duration (50 mS. x M) + 60 mS. (Default: 110 mS.)
  - L9 to L12 = CO Hookflash time (100 mS. x M) + 300 mS. (Default: 1500 mS.)
- Depressing the ENTER key causes the display to increment to the next channel, or the first channel of the next slot with a COI-E ETU.

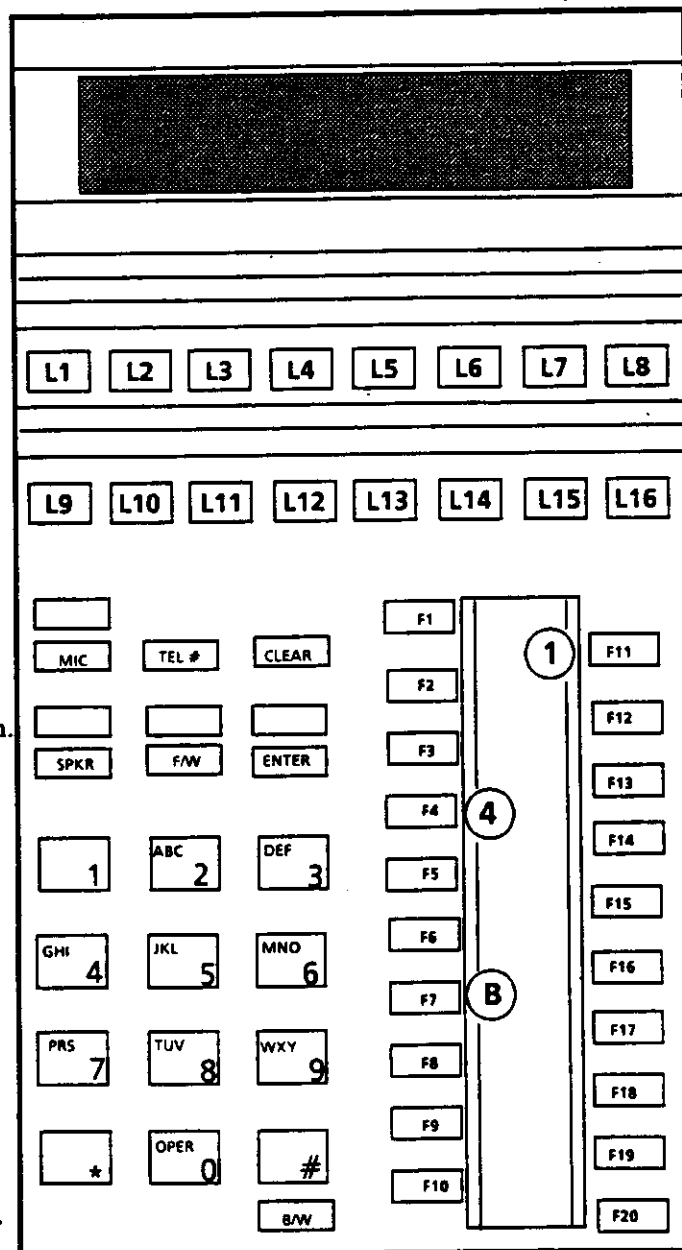

LED OFF means upper parameter

LED	L1	L2	L3	L4	L5	L6	L7	L8
OFF	10 PPS	MF	CO	NO	DTMF DURATION			
ON	20 PPS	DP	PBX	YES	2 <sup>3</sup>	2 <sup>2</sup>	2 <sup>1</sup>	2 <sup>0</sup>

LED	L9	L10	L11	L12	L13	L14	L15	L16
OFF	CO HOOKFLASH TIME							
ON	2 <sup>3</sup>	2 <sup>2</sup>	2 <sup>1</sup>	2 <sup>0</sup>				

**GENERAL INFORMATION - COI-I INITIALIZED VALUES**

This area of the memory block is used to set the desired parameters to COI-E ports on a per port (channel) basis.

**MEMORY BLOCK 4B2 - COI-II INITIALIZED VALUES**

OPERATION ← AND → DISPLAY

1. Go off line.
 

O	F	F	-	L	I	N	E		(	X	.	X	X	)
P	R	O	G	R	A	M		M	O	D	E			
  
2. Depress F4, then F7.
 

C	A	R	D		M	O	D	E						
  
3. Depress F12.
 

C	O	I		I	N	I	T	I	A	L	I	Z	E	2
M	O	D	?		S	L	O	T	*		C	H	*	
  
4. Dial module number (1 ~ 4) of COI port to be assigned. Example: Module 1.
 

C	O	I		I	N	I	T	I	A	L	I	Z	E	2
M	O	D	1		S	L	O	T	?		C	H	*	
  
5. Dial slot number (1 ~ 8) of COI port to be assigned. Example: Slot 2.
 

C	O	I		I	N	I	T	I	A	L	I	Z	E	2
M	O	D	1		S	L	O	T	2		C	H	?	
  
6. Dial channel number (1 ~ 4) of COI port to be assigned. Example: Channel 1. (See Note 2).
 

C	O	I		I	N	I	T	I	A	L	I	Z	E	2
M	O	D	1		S	L	O	T	2		C	H	1	
  
7. Depress L1 to L16 to set the desired parameters of the COI port.
8. Depress ENTER key. (See Note 3).
9. Repeat steps 7 and 8 for all additional COI ports as required or go to step 3 to select a particular COI port.
10. Depress the SPKR key to go back on line.

**KEY FUNCTION (OFF LINE)**

<b>SPKR - ON/OFF Line</b>
<b>TEL # - Enters new port number.</b>
<b>F/W (Forward) - Increments channel number</b>
<b>CLEAR -</b>
<b>ENTER - Enters each assignment</b>
<b>B/W (Backward) - Decrements channel number</b>

**GUIDE TO FEATURE PROGRAMMING**

MEMORY BLOCK BEING PROGRAMMED	MEMORY BLOCK THAT MUST BE PROGRAMMED	MEMORY BLOCK THAT MAY HAVE TO BE PROGRAMMED
<b>4B2</b>		<b>4B1, 4B6, 4B7</b>

LINE BUTTONS					MULTIPLIER (M)
L1	L2	L3	L4	(HP)	
L5	L6	L7	L8	(DR)	
L9	L10	L11	L12	(PS)	
L13	L14	L15	L16	(IDI)	
0	0	0	0		0
0	0	0	1		1
0	0	1	0		2
0	0	1	1		3
0	1	0	0		4
0	1	0	1		5
0	1	1	0		6
0	1	1	1		7
1	0	0	0		8
1	0	0	1		9
1	0	1	0		10
1	0	1	1		11
1	1	0	0		12
1	1	0	1		13
1	1	1	0		14

Multiplier = M

HP (Hit Protection) Time = 50 mS. x M  
 (Default: 350 mS.)

PS (Pause) Time = 500 mS. x M (Default: 1000 mS.)

IDI (Interdigit Interval) Time = (10 mS. x M) + 40 mS.

(Default: 70 mS.)

DR (Disconnect Recognition) Time = 100 mS. x M  
 (Default: 300 mS.)

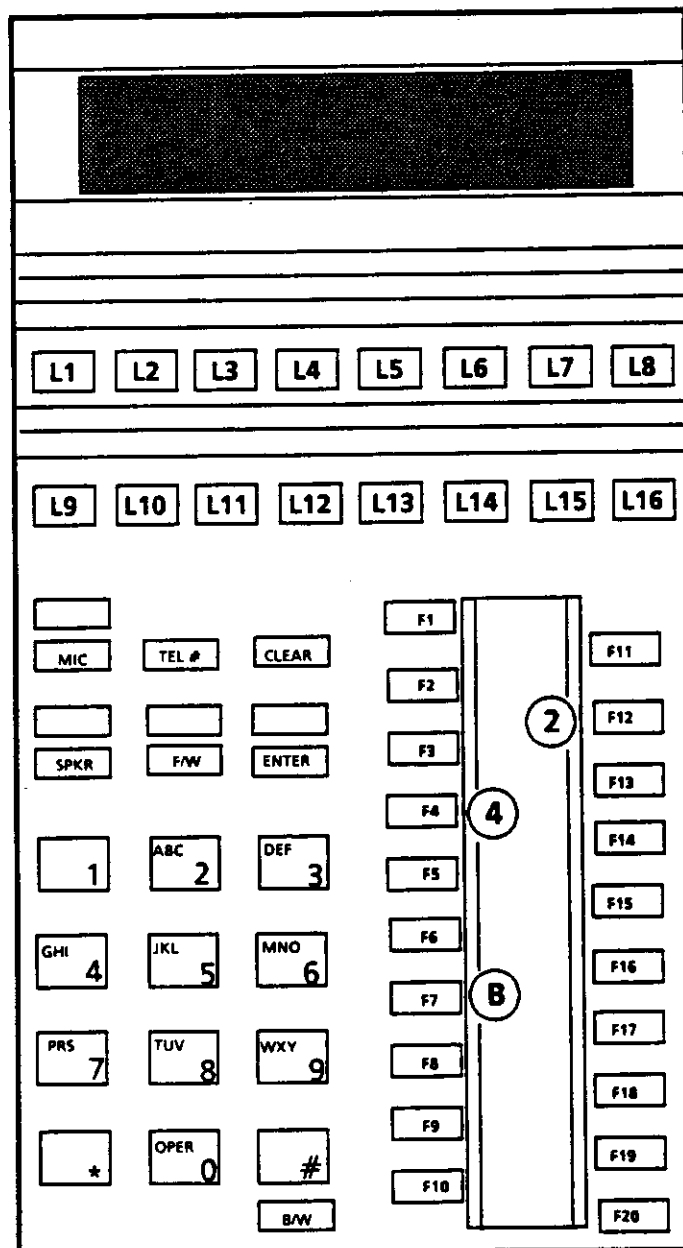

**NOTES:** All CPU levels.

1. It is recommended that 4B7 be programmed prior to 4B2, since 4B7 programming overrides all 4B2 programming already done for all the trunks within that trunk group.
2. During step 6 the status of L1 to L16 will indicate the previous parameters set to the COI port (See chart).
3. Depressing the ENTER key causes the display to increment to the next channel, or the first channel of the next slot containing a COI-E ETU.

**GENERAL INFORMATION - COI-II INITIALIZED VALUES**

This area of the memory block is used to assign timing parameters to each COI port. For a description of each parameter, see section 350.

**MEMORY BLOCK 4B3 - SLI COMMON VALUES**

**OPERATION** ← **AND** → **DISPLAY**

1. Go off line.

	O	F	F	-	L	I	N	E		(	X	.	X	X	)
	P	R	O	G	R	A	M		M	O	D	E			

2. Depress F4, then F7.

C	A	R	D		M	O	D	E							

3. Depress F13. (See Note 1).

S	L	I		I	N	I	T	I	A	L	I	Z	E		
S	L	I		C	O	M	M	O	N						

4. Depress L1 to L12 to set the desired SLI common values.
5. Depress ENTER key.
6. Depress the SPKR key to go back on line.

**KEY FUNCTION (OFF LINE)**

SPKR - ON/OFF Line
TEL # -
F/W (Forward) -
CLEAR -
ENTER - Enters SLI common values.
B/W (Backward) -

**GUIDE TO FEATURE PROGRAMMING**

MEMORY BLOCK BEING PROGRAMMED	MEMORY BLOCK THAT MUST BE PROGRAMMED	MEMORY BLOCK THAT MAY HAVE TO BE PROGRAMMED
<b>4B3</b>		

LINE BUTTONS					MULTIPLIER (M)
L1	L2	L3	L4	(HFS)	
L5	L6	L7	L8	(HFE)	
L9	L10	L11	L12	(BP)	
0	0	0	0		0
0	0	0	1		1
0	0	1	0		2
0	0	1	1		3
0	1	0	0		4
0	1	0	1		5
0	1	1	0		6
0	1	1	1		7
1	0	0	0		8
1	0	0	1		9
1	0	1	0		10
1	0	1	1		11
1	1	0	0		12
1	1	0	1		13
1	1	1	0		14

Multiplier = M

HFS (Hookflash Start) Time = (50 mS. x M) + 100 mS. (Default: 300 mS.)

HFE (Hookflash End) Time = (HFS x M) + 100 mS. (Default: 1000 mS.)

BP (Bounce Protect) Time = 100 mS. x M (Default: 300 mS.)

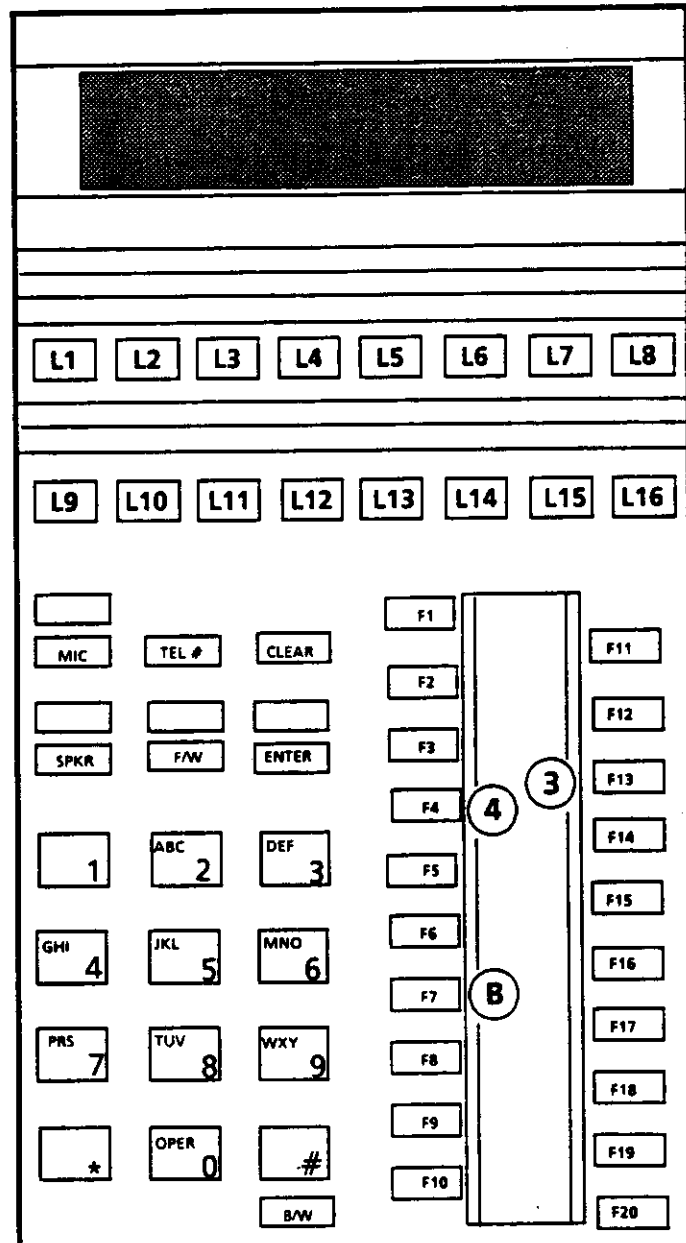

All CPU levels.

**NOTES:**

1. During step 3 the status of L1 to L12 will indicate the previous SLI Common values assigned (See chart).

**GENERAL INFORMATION - SLI COMMON VALUES**

This area of the memory block is used to assign timing parameters to all single line telephones. See Section 350 for a description of each parameter.

**MEMORY BLOCK 4B4 - ESI-EB DATA AND SECOND VOICE PATH ASSIGNMENT**

OPERATION ← AND → DISPLAY

1. Go off line.

	O	F	F	-	L	I	N	E		(	X	.	X	X	)
	P	R	O	G	R	A	M		M	O	D	E			

2. Depress F4, then F7.

C	A	R	D		M	O	D	E							

3. Depress F14.

E	S	I		I	N	I	T	I	A	L	I	Z	E		
M	O	D	U	L	E	?			S	L	O	T	*		

4. Dial module number (1 ~ 4) of ESI card to be assigned. Example: Module 2.

E	S	I		I	N	I	T	I	A	L	I	Z	E		
M	O	D	U	L	E	2			S	L	O	T	?		

5. Dial slot number (1 ~ 8) of ESI card to be assigned. Example: Slot 4. (See Note 1).

E	S	I		I	N	I	T	I	A	L	I	Z	E		
M	O	D	U	L	E	2			S	L	O	T	4		

6. Depress L1 to L8 to assign each ESI port as required. (See Note 2).

7. Depress ENTER key. (See Note 3).

E	S	I		I	N	I	T	I	A	L	I	Z	E		
M	O	D	U	L	E	2			S	L	O	T	5		

8. Repeat steps 6 and 7 for each ESI card as required or go to step 3 to select a particular ESI-EB port.

9. Depress the SPKR key to go back on line.

**KEY FUNCTION (OFF LINE)**

<b>SPKR - ON/OFF Line</b>
<b>TEL # - Enters new module and slot number</b>
<b>F/W - Increments to next ESI slot</b>
<b>CLEAR -</b>
<b>ENTER - Enters each ESI path assignment</b>
<b>B/W - Decrements to next ESI slot</b>

**GUIDE TO FEATURE PROGRAMMING**

MEMORY BLOCK BEING PROGRAMMED	MEMORY BLOCK THAT MUST BE PROGRAMMED	MEMORY BLOCK THAT MAY HAVE TO BE PROGRAMMED
<b>4B4</b>		1D2, 1A

All CPU levels (See Note 1).

**NOTES:**

- During step 5 the display will show the previous ESI path assignment for the ESI ports chosen. Although a slot associated with an ESI-EA ETU can be accessed and will display it's path assignment, no assignments can actually be changed. See figure below:

L1	L2	L3	L4	L5	L6	L7	L8
DATA	DUAL VOICE	DATA	DUAL VOICE	DATA	DUAL VOICE	DATA	DUAL VOICE
CH 1		CH 2		CH 3		CH 4	

L1	L2	Channel 1
L3	L4	Channel 2
L5	L6	Channel 3
L7	L8	Channel 4
OFF	OFF	Single Voice Path
OFF	ON	Dual Voice Path
ON	OFF	Data (CPU-EB or higher)
ON	ON	Data and Dual Voice (CPU-EB or higher)

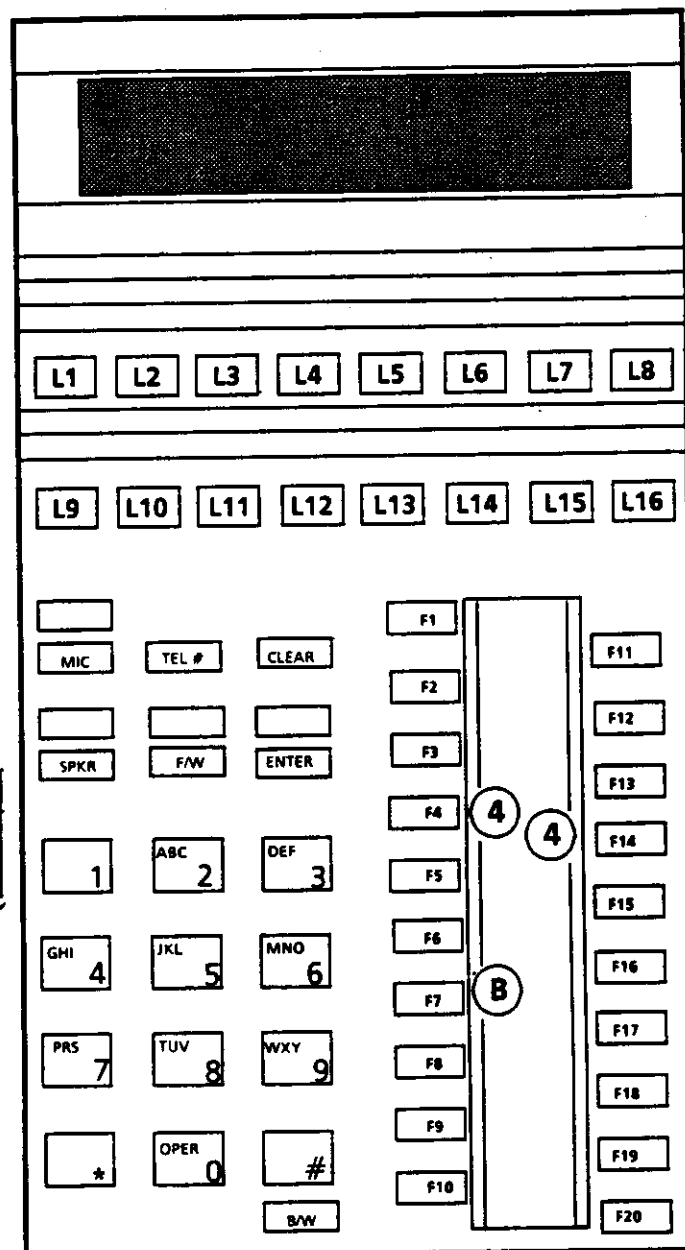

- Only Channels 1 and 3 can be assigned for both data and dual voice path. For this to be done, the next adjacent channel(s) (Channel 2 and/or Channel 4) must be assigned single voice only, however, data and single voice can be assigned to all four channels.
- Depressing the ENTER key will cause the display to increment to the next ESI slot.
- ETE-6( ) or ETE-16-2 Multiline Terminals are not compatible with data or dual path features.

**GENERAL INFORMATION - ESI-EB DATA AND SECOND VOICE PATH ASSIGNMENT**

This area of the memory block is used to assign data capability and/or a second voice path to an ESI-EB port. Multiline Terminals assigned a dual path are able to receive a voice page while off-hook, when its primary extension line is idle. All dual path terminals have to be equipped with a Dual Path Adaptor (DPA-E), and assigned to an ESI-EB ETU. All stations assigned for data capability must be equipped with a data adaptor (DTA-E) and assigned to an ESI-EB ETU in CCUs 1 thru 3.

**MEMORY BLOCK 4B6 - COI-III INITIALIZED VALUES**

OPERATION      ← AND →      DISPLAY

1. Go off line.

	O	F	F	-	L	I	N	E		(	X	.	X	X	)
	P	R	O	G	R	A	M		M	O	D	E			

2. Depress F4, then F7.

C	A	R	D		M	O	D	E							

3. Depress F16.

C	O	I		I	N	I	T	I	A	L	I	Z	E	3	
T	R	U	N	K		G	R	O	U	P	?				

4. Dial trunk group number (1 ~ 8) to be assigned.  
 Example: Trunk Group 2.  
 (See Note 1).

C	O	I		I	N	I	T	I	A	L	I	Z	E	3	
T	R	U	N	K		G	R	O	U	P	2				

5. Depress L1 to L12 to set the desired parameters of the CO group. Corresponding LED(s) go on or off accordingly.

6. Depress ENTER key. (See Note 2).

C	O	I		I	N	I	T	I	A	L	I	Z	E	3	
T	R	U	N	K		G	R	O	U	P	3				

7. Repeat steps 5 and 6 for each CO group required or go to step 3 to select a particular trunk group number.

8. Depress the SPKR key to go back on line.



**KEY FUNCTION (OFF LINE)**

<b>SPKR</b> - ON/OFF line
<b>TEL #</b> - Selects trunk group number
<b>F/W</b> - Increments trunk group number
<b>CLEAR</b> -
<b>ENTER</b> - Enters each assignment
<b>B/W</b> - Decrements trunk group number

**GUIDE TO FEATURE PROGRAMMING**

MEMORY BLOCK BEING PROGRAMMED	MEMORY BLOCK THAT MUST BE PROGRAMMED	MEMORY BLOCK THAT MAY HAVE TO BE PROGRAMMED
<b>4B6</b>		4B1, 4B2, 4B7

All CPU levels (See Note 1, L4).

**NOTES:**

- During step 4, the status of L1 to L12 LEDs indicate the current parameters set to the trunk group chosen. See figure below.

- L1 = 10 or 20 PPS for rotary dialing (Default: 10 PPS)
- L2 = Rotary or DTMF dialing (Default: DTMF)
- L3 = CO or PBX line interface (Default: CO)
- L4 = Disconnect Signal from CO (YES/NO) (Default: NO) (CPU-EB2 or higher)
- L5 to L8 = DTMF digit duration (In binary form) (M x 50 mS.) + 60 mS. (Default: 110 mS.)
- L9 to L12 = CO Hookflash time (In binary form) (M x 100 mS.) + 300 mS. (Default: 1500 mS.)

- Depressing the ENTER key causes the display to increment to the next trunk group.

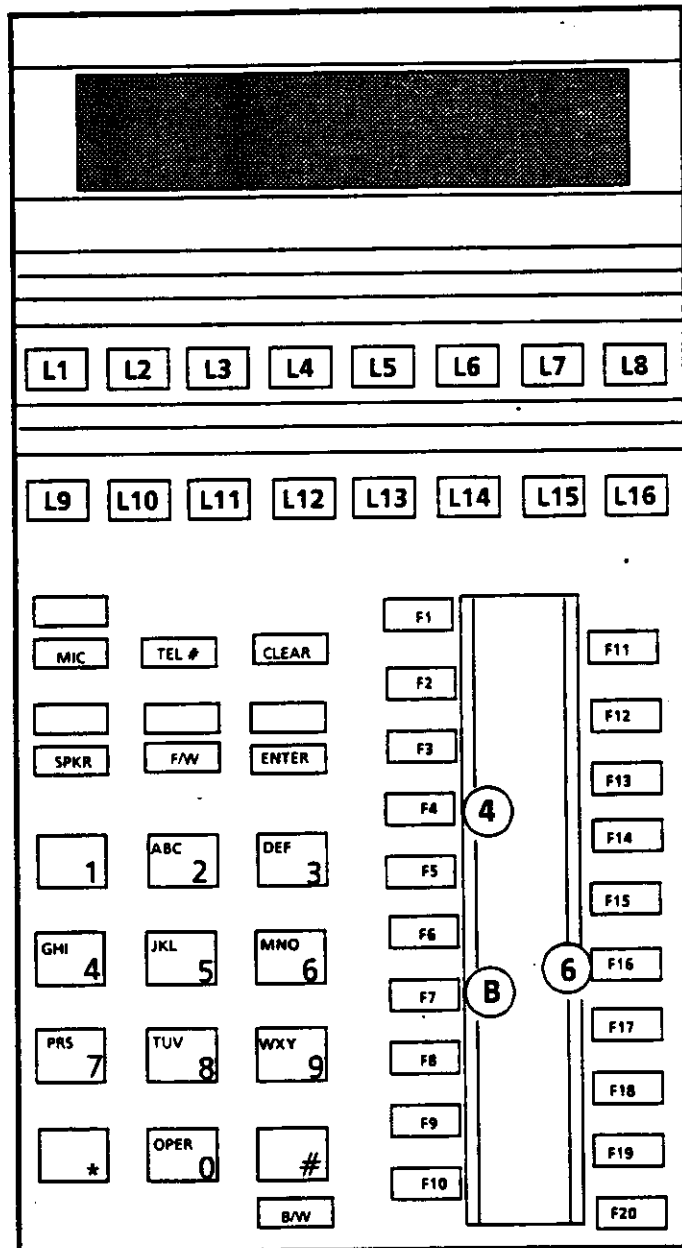

LED OFF means upper parameter

LED	L1	L2	L3	L4	L5	L6	L7	L8
OFF	10 PPS	MF	CO	NO	DTMF DURATION			
ON	20 PPS	DP	PBX	YES	2 <sup>3</sup>	2 <sup>2</sup>	2 <sup>1</sup>	2 <sup>0</sup>
LED	L9	L10	L11	L12	L13	L14	L15	L16
OFF	CO HOOKFLASH TIME							
ON	2 <sup>3</sup>	2 <sup>2</sup>	2 <sup>1</sup>	2 <sup>0</sup>				

**GENERAL INFORMATION - COI-III INITIALIZED VALUES**

This area of the memory block is used to set the desired parameters to the COI-E circuits. These settings are on a trunk group basis. For a description of these parameters, see Section 350.

**MEMORY BLOCK 4B7 - COI-IV INITIALIZED VALUES  
 PROGRAMMING PARAMETERS**

OPERATION ← AND → DISPLAY

1. Go off line.

	O	F	F	-	L	I	N	E		(	X	.	X	X	)
	P	R	O	G	R	A	M		M	O	D	E			

2. Depress F4, then F7.

C	A	R	D		M	O	D	E							

3. Depress F17.

C	O	I		I	N	I	T	I	A	L	I	Z	E	4	
T	R	U	N	K		G	R	O	U	P	?				

4. Dial trunk group number (1 ~ 8) to be assigned.  
 Example: Trunk Group 4. (See Note 1).

C	O	I		I	N	I	T	I	A	L	I	Z	E	4	
T	R	U	N	K		G	R	O	U	P	4				

5. Depress L1 to L16 to set timing parameters to the trunk group.

6. Depress ENTER key. (See Note 2).

C	O	I		I	N	I	T	I	A	L	I	Z	E	4	
T	R	U	N	K		G	R	O	U	P	5				

7. Repeat steps 5 and 6 for all trunk groups required or go to step 3 to select a particular trunk group.

8. Depress the SPKR key to go back on line.

**KEY FUNCTION (OFF LINE)**

<b>SPKR</b> - ON/OFF Line
<b>TEL #</b> - Enter new trunk group
<b>F/W</b> - Increment trunk group
<b>CLEAR</b> -
<b>ENTER</b> - Enter each trunk group assigned
<b>B/W</b> - Decrement trunk group

**GUIDE TO FEATURE PROGRAMMING**

MEMORY BLOCK BEING PROGRAMMED	MEMORY BLOCK THAT MUST BE PROGRAMMED	MEMORY BLOCK THAT MAY HAVE TO BE PROGRAMMED
<b>4B7</b>		4B1, 4B2, 4B6

LINE BUTTONS					MULTIPLIER (M)
L1	L2	L3	L4	(HP)	
L5	L6	L7	L8	(DR)	
L9	L10	L11	L12	(PS)	
L13	L14	L15	L16	(IDI)	
0	0	0	0		0
0	0	0	1		1
0	0	1	0		2
0	0	1	1		3
0	1	0	0		4
0	1	0	1		5
0	1	1	0		6
0	1	1	1		7
1	0	0	0		8
1	0	0	1		9
1	0	1	0		10
1	0	1	1		11
1	1	0	0		12
1	1	0	1		13
1	1	1	0		14

Multiplier = M

HP (Hit Protection) Time =  
50 mS. x M (Default: 350 mS.)

PS (Pause) Time =  
500 mS. x M (Default: 1000 mS.)

IDI (Interdigit Interval) Time =  
(M x 10 mS.) + 40 mS. (Default: 70 mS.)

DR (Disconnect Recognition) Time =  
100 mS. x M (Default: 300 mS.)

**GENERAL INFORMATION - COI-IV INITIALIZED VALUES PROGRAMMING PARAMETERS**

This area of the memory block is used to assign timing parameters to trunk groups. For a description of these parameters see section 350.

All CPU levels.

**NOTES:**

1. During step 4 the status of L1 to L16 indicate the previous timing parameters assigned to the trunk group chosen.
2. Depressing the ENTER key causes the display to increment to the next CO group.

### MEMORY BLOCK 4B8 - VMI INITIALIZE 1 ASSIGNMENT

OPERATION      ← AND →      DISPLAY

1. Go off line.

		O	F	F	-	L	I	N	E		(	X	.	X	X	)
		P	R	O	G	R	A	M		M	O	D	E			

2. Depress F4, then F7.

		C	A	R	D		M	O	D	E						

3. Depress F18.

		V	M	I		I	N	I	T	I	A	L	I	Z	E	1
		M	O	D	?		S	L	O	T	*		C	H	*	

4. Dial the module number to be assigned.  
 Example: Module 1.

		V	M	I		I	N	I	T	I	A	L	I	Z	E	1
		M	O	D	1		S	L	O	T	?		C	H	*	

5. Dial the slot number to be assigned.  
 Example: Slot 7.

		V	M	I		I	N	I	T	I	A	L	I	Z	E	1
		M	O	D	1		S	L	O	T	7		C	H	?	

6. Dial the channel number to be assigned.  
 Example: Channel 1. (See Note 1).

		V	M	I		I	N	I	T	I	A	L	I	Z	E	1
		M	O	D	1		S	L	O	T	7		C	H	1	

7. Depress L1 to L12 to set the desired timing parameters of the selected VMI port. (See Note 2).

8. Depress ENTER key. (See Note 3).

		V	M	I		I	N	I	T	I	A	L	I	Z	E	1
		M	O	D	1		S	L	O	T	7		C	H	2	

9. Repeat steps 7 and 8 for all VMI ports to be assigned.

10. Depress the SPKR key to go back on line.

**KEY FUNCTION (OFF LINE)**

<b>SPKR</b> - ON/OFF Line
<b>TEL #</b> - Selects new mod, slot, channel location
<b>F/W</b> - Increments channel number
<b>CLEAR</b> -
<b>ENTER</b> - Enters each assignment
<b>B/W</b> - Decrements channel number

**GUIDE TO FEATURE PROGRAMMING**

MEMORY BLOCK BEING PROGRAMMED	MEMORY BLOCK THAT MUST BE PROGRAMMED	MEMORY BLOCK THAT MAY HAVE TO BE PROGRAMMED
<b>4B8</b>		<b>4B9</b>

All CPU levels.

**NOTES:**

- During step 6, L1 ~ L12 shows the previous assignments.

2.

LINE BUTTONS				MULTIPLIER (M)
L1	L2	L3	L4 (HFS)	
L5	L6	L7	L8 (HFE)	
L9	L10	L11	L12 (BP)	
0	0	0	0	0
0	0	0	1	1
0	0	1	0	2
0	0	1	1	3
0	1	0	0	4
0	1	0	1	5
0	1	1	0	6
0	1	1	1	7
1	0	0	0	8
1	0	0	1	9
1	0	1	0	10
1	0	1	1	11
1	1	0	0	12
1	1	0	1	13
1	1	1	0	14

Multiplier = M

HFS (Hookflash Start) Time = (50 mS. x M) + 100 mS. (Default: 300 mS.)

HFE (Hookflash End) Time = (100 mS. x M) + HFS (Default: 1000 mS.)

BP (Bounce Protect) Time = 100 mS. x M (Default: 300 mS.)

- Depressing the ENTER key will increment the display to the next VMI port.

**GENERAL INFORMATION - VMI INITIALIZE 1 ASSIGNMENT**

This area of the memory block is used to assign various signal timing parameters to each VMI port.

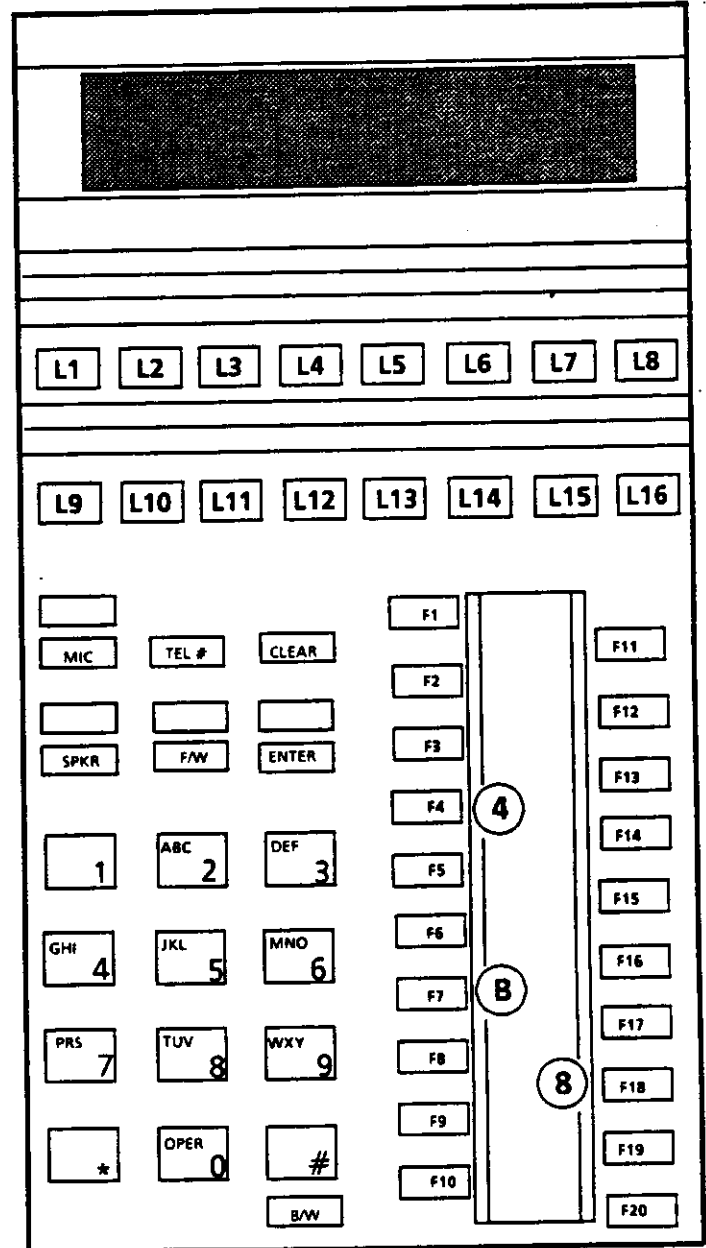

**MEMORY BLOCK 4B9 - VMI INITIALIZE 2 ASSIGNMENT**

OPERATION ← AND → DISPLAY

1. Go off line.

O	F	F	-	L	I	N	E		(	X	.	X	X	)
P	R	O	G	R	A	M		M	O	D	E			

2. Depress F4, then F7.

C	A	R	D		M	O	D	E						

3. Depress F19.

V	M	I		I	N	I	T	I	A	L	I	Z	E	2
M	O	D	?		S	L	O	T	*		C	H	*	

4. Dial the module number to be assigned.  
 Example: Module 1.

V	M	I		I	N	I	T	I	A	L	I	Z	E	2
M	O	D	1		S	L	O	T	?		C	H	*	

5. Dial the slot number to be assigned.  
 Example: Slot 7.

V	M	I		I	N	I	T	I	A	L	I	Z	E	2
M	O	D	1		S	L	O	T	7		C	H	?	

6. Dial the channel number to be assigned.  
 Example: Channel 1. (See Note 1).

V	M	I		I	N	I	T	I	A	L	I	Z	E	2
M	O	D	1		S	L	O	T	7		C	H	1	

7. Depress L1 to L16 to set the desired timing parameters of the selected VMI port. (See Note 2).

8. Depress ENTER key. (See Note 3).

V	M	I		I	N	I	T	I	A	L	I	Z	E	2
M	O	D	1		S	L	O	T	7		C	H	2	

9. Repeat steps 7 and 8 for all VMI ports to be assigned.

10. Depress the SPKR key to go back on line.

**KEY FUNCTION (OFF LINE)**

<b>SPKR</b> - ON/OFF Line
<b>TEL #</b> - Selects new mod, slot, channel location
<b>F/W</b> - Increments channel number
<b>CLEAR</b> -
<b>ENTER</b> - Enters each assignment
<b>B/W</b> - Decrements channel number

**GUIDE TO FEATURE PROGRAMMING**

MEMORY BLOCK BEING PROGRAMMED	MEMORY BLOCK THAT MUST BE PROGRAMMED	MEMORY BLOCK THAT MAY HAVE TO BE PROGRAMMED
<b>4B9</b>		<b>4B8</b>

All CPU levels.

**NOTES:**

1. During step 6, L1 ~ L16 show the current assignments.

2.

LINE BUTTONS				MULTIPLIER (M)
L1	L2	L3	L4	
L5	L6	L7	L8	
L9	L10	L11	L12	
L13	L14	L15	L16	
				INTERDIGIT INTERVAL TIME
				DTMF DIGIT DURATION
				PAUSE TIME
				DISCONNECT TIME
0	0	0	0	0
0	0	0	1	1
0	0	1	0	2
0	0	1	1	3
0	1	0	0	4
0	1	0	1	5
0	1	1	0	6
0	1	1	1	7
1	0	0	0	8
1	0	0	1	9
1	0	1	0	10
1	0	1	1	11
1	1	0	0	12
1	1	0	1	13
1	1	1	0	14

Multiplier = M

Interdigit Interval Time = 40 mS. + (10 mS. x M) (Default: 110 mS.)

DTMF Digit Duration = 60 mS. + (50 mS. x M) (Default: 110 mS.)

Pause Time = 500 mS. x M (Default: 1000 mS.)

Disconnect Time = 500 mS. + (200 mS. x M) (Default: 1500 mS.)

3. Depressing the ENTER key will increment the display to the next VMI port.

**GENERAL INFORMATION - VMI INITIALIZE 2 ASSIGNMENT**

This area of the memory block is used to assign various signal timing parameters to each VMI port.

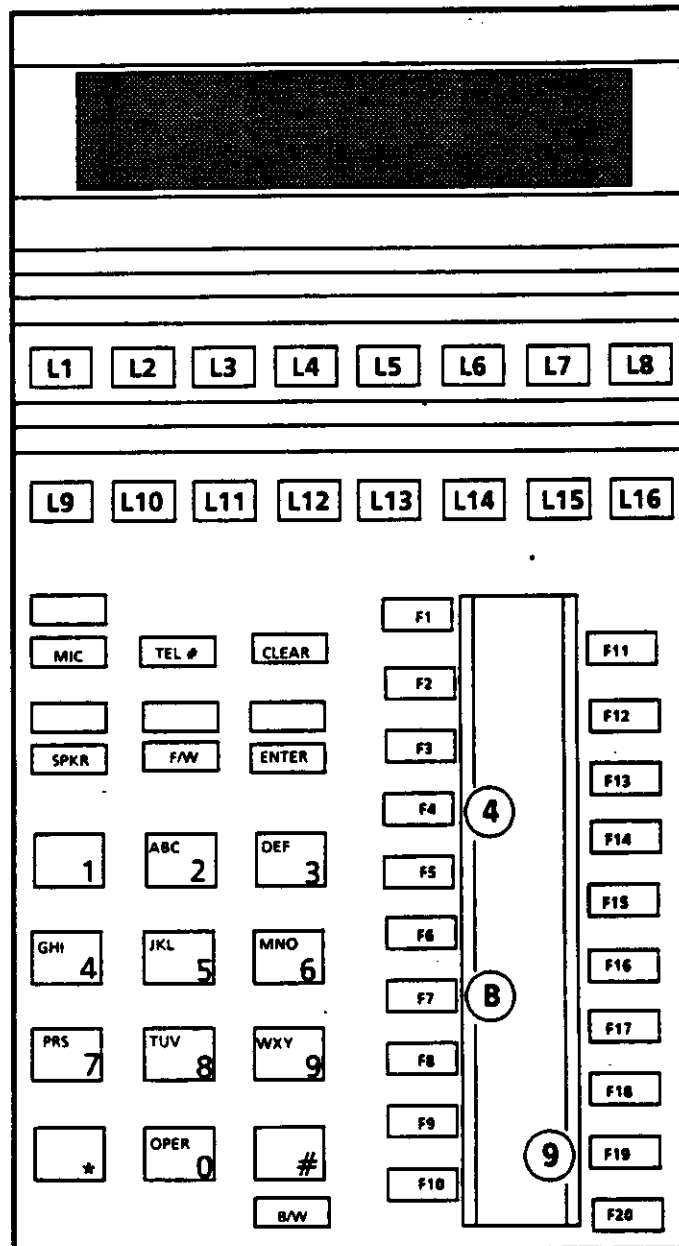

## MEMORY BLOCK 4C1 - CARD INTERFACE SLOT ASSIGNMENT

OPERATION ← AND → DISPLAY

1. Go off line.

O	F	F	-	L	I	N	E		(	X	.	X	X	)
P	R	O	G	R	A	M		M	O	D	E			

2. Depress F4, then F8.

C	A	R	D		I	N	T	E	R	F	A	C	E	

3. Depress F11.

I	N	T	E	R	F	A	C	E		A	S	S	I	G	N
M	O	D	U	L	E	?				S	L	O	T	*	

4. Dial module number (1 ~ 4) of the slot to be assigned. Example: Module 2.

I	N	T	E	R	F	A	C	E		A	S	S	I	G	N
M	O	D	U	L	E	2				S	L	O	T	?	

5. Dial slot number (1 ~ 8) to be set.  
 Example: Slot 4. (See Note 1).

I	N	T	E	R	F	A	C	E		A	S	S	I	G	N
M	O	D	U	L	E	2				S	L	O	T	4	

6. Depress one of the line keys (L1 to L11) to assign the required card to the slot chosen.

7. Depress ENTER key. (See Note 2).

I	N	T	E	R	F	A	C	E		A	S	S	I	G	N
M	O	D	U	L	E	2				S	L	O	T	5	

8. Repeat steps 6 and 7 for all slots required or go to step 3 to select a particular interface slot.

9. Depress the SPKR key to go back on line.



**KEY FUNCTION (OFF LINE)**

<b>SPKR</b> - ON/OFF Line
<b>TEL #</b> - Enters new module and slot number
<b>F/W</b> - Increments slot number
<b>CLEAR</b> -
<b>ENTER</b> - Enters each slot assignment
<b>B/W</b> - Decrements slot number

**GUIDE TO FEATURE PROGRAMMING**

MEMORY BLOCK BEING PROGRAMMED	MEMORY BLOCK THAT MUST BE PROGRAMMED	MEMORY BLOCK THAT MAY HAVE TO BE PROGRAMMED
<b>4C1</b>		<b>4C2</b>

All CPU levels.

**NOTES:**

1. During step 5 the status of L1 to L16 indicates the type of card assigned to the slot chosen. See figure below:

L1	L2	L3	L4	L5	L6		L8
COI	TLI	SLI	MFR EA	NOT USED	CNF		VMI

L9	L10	L11					L16
ESI EA	ESI EB	ECR					VACANT

**LED**

ON: Assigned  
OFF: Not assigned

2. Depressing the ENTER key will cause the display to increment to the next slot.
3. ESI assignment cannot be removed or changed to a different type of card when:
  - ETE-16D-( ) has BLF assignments.
  - ATTENDANT Multiline Terminal is assigned.
  - Programming Multiline Terminal is assigned.

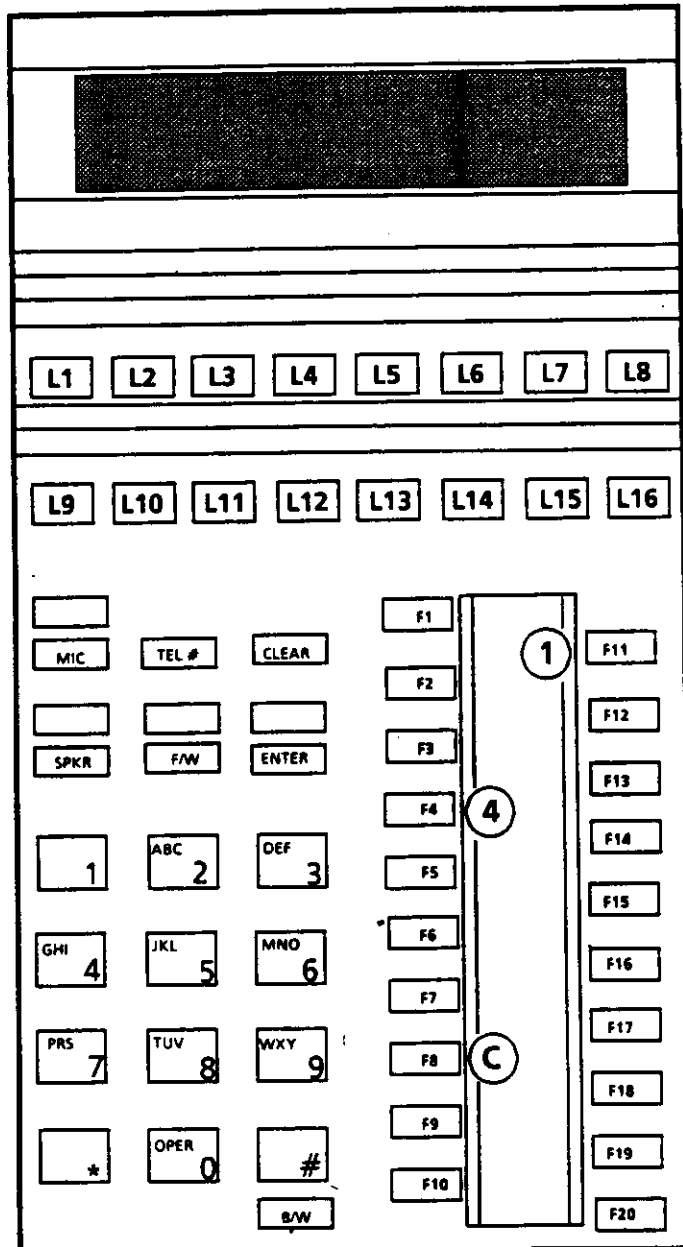

**GENERAL INFORMATION - CARD INTERFACE SLOT ASSIGNMENT**

This area of the memory block is used to assign interface cards to the CCU Interface slots.

## MEMORY BLOCK 4C2 - INTERFACE SLOT BUSY OUT ASSIGNMENT

OPERATION      ← AND →      DISPLAY

1. Go off line.

	O	F	F	-	L	I	N	E		(	X	.	X	X	)
	P	R	O	G	R	A	M		M	O	D	E			

2. Depress F4, then F8.

C	A	R	D		I	N	T	E	R	F	A	C	E		

3. Depress F12.

I	N	T	E	R	F	A	C	E		B	U	S	Y		
M	O	D	U	L	E	?				S	L	O	T	*	

4. Dial module number (1 ~ 4) of the slot to be set.  
 Example: Module 1.

I	N	T	E	R	F	A	C	E		B	U	S	Y		
M	O	D	U	L	E	1				S	L	O	T	?	

5. Dial slot number (1 ~ 8) to be set.  
 Example: Slot 4. (See Note 1).

I	N	T	E	R	F	A	C	E		B	U	S	Y		
M	O	D	U	L	E	1				S	L	O	T	4	

6. Depress one of the line keys (L1 to L11) to set the interface slot as required.

7. Depress ENTER key. (See Note 2).

I	N	T	E	R	F	A	C	E		B	U	S	Y		
M	O	D	U	L	E	1				S	L	O	T	5	

8. Repeat steps 6 and 7 for each slot required or go to step 3 to select a particular interface slot.

9. Depress the SPKR key to go back on line.

**KEY FUNCTION (OFF LINE)**

SPKR - ON/OFF Line
TEL # - Enters new module and slot number
F/W - Increments slot number
CLEAR -
ENTER - Enters each slot assigned
B/W - Decrements slot number

**GUIDE TO FEATURE PROGRAMMING**

MEMORY BLOCK BEING PROGRAMMED	MEMORY BLOCK THAT MUST BE PROGRAMMED	MEMORY BLOCK THAT MAY HAVE TO BE PROGRAMMED
4C2		4C1

All CPU levels.

**NOTES:**

- During step 5 the status of L1 to L16 indicates the type of card and status for the slot chosen. See figure below:

L1	L2	L3	L4	L5	L6	L7	L8
COI	TLI	SLI	MFR A	NOT USED	CNF		VMI

  

L9	L10	L11					L16
ESI A	ESI B	ECR					NOT USED

**LED**

- ON: Not busied out
- OFF: Not assigned
- FLASHING: Busied out

- Depressing the ENTER key will cause the display to increment to the next slot.

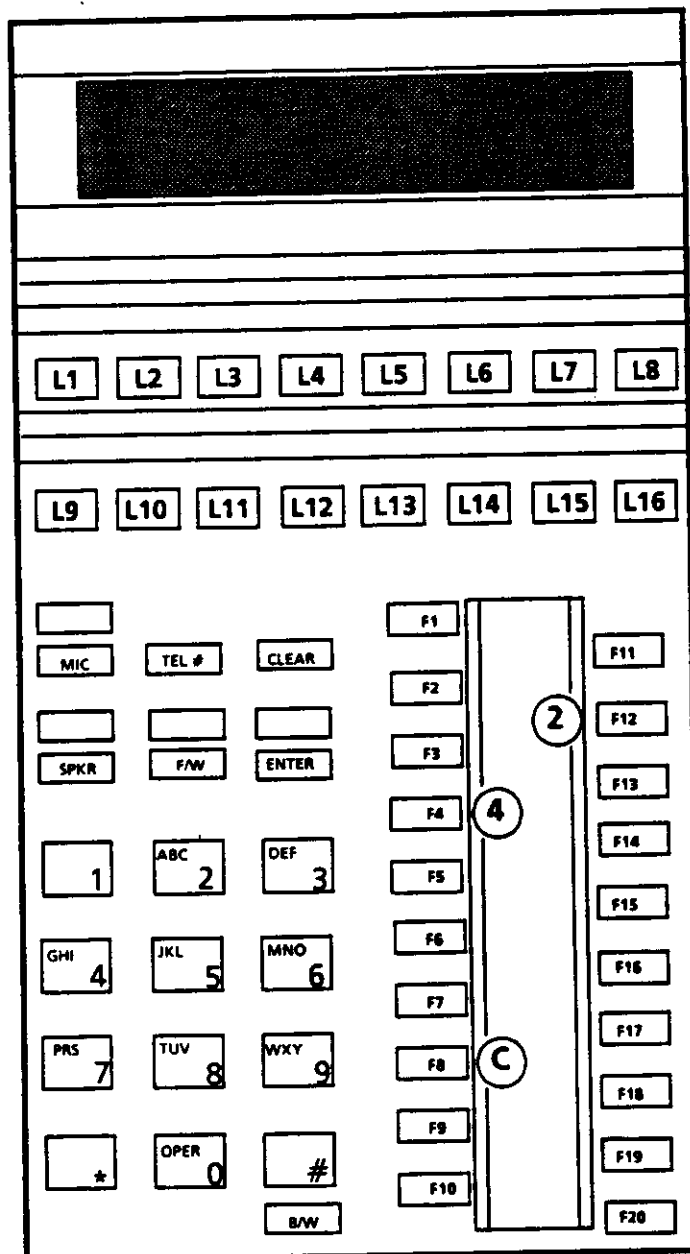

**GENERAL INFORMATION - INTERFACE SLOT BUSY OUT ASSIGNMENT**

This area of the memory block is used to busy out or restore individual interface slots in the system.

**MEMORY BLOCK 4E1 - TLI LINE TYPE ASSIGNMENT**

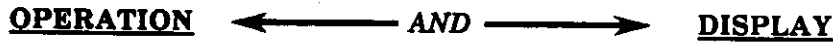

1. Go off line.

	O	F	F	-	L	I	N	E		(	X	.	X	X	)
	P	R	O	G	R	A	M		M	O	D	E			

2. Depress F4, then F10.

T	L	I		P	R	O	G	R	A	M	M	I	N	G	

3. Depress F11.

S	E	L	E	C	T		L	I	N	E		T	Y	P	E
T	R	U	N	K		G	R	O	U	P	?				

4. Dial the number of the Trunk Group (1 ~ 8) to be assigned. Example: Trunk Group 2. (See Note 1).

L	I	N	E		T	Y	P	E		T	R	K	.	G	2
2	N	D		D	I	A	L		T	O	N	E			

5. Dial the number (1 ~ 4) of the line type to be assigned. Example: 3. (See Note 2).

L	I	N	E		T	Y	P	E		T	R	K	.	G	2
D	E	L	A	Y											

6. Depress the ENTER key. (See Note 3).

S	E	L	E	C	T		L	I	N	E		T	Y	P	E
T	R	U	N	K		G	R	O	U	P	?				

7. Repeat Steps 4 thru 6 for all Trunk Groups, associated with a TLI-E( ) ETU, to be programmed.

8. Depress SPKR key to go back on-line.

**KEY FUNCTION (OFF LINE)**

<b>SPKR</b> - ON/OFF Line
<b>TEL #</b> - Enters new Trunk Group number
<b>F/W</b> - Increments Trunk Group number
<b>CLEAR</b> -
<b>ENTER</b> - Enters each assignment
<b>B/W</b> - Decrements Trunk Group number

**GUIDE TO FEATURE PROGRAMMING**

MEMORY BLOCK BEING PROGRAMMED	MEMORY BLOCK THAT MUST BE PROGRAMMED	MEMORY BLOCK THAT MAY HAVE TO BE PROGRAMMED
<b>4E1</b>	2C1	4E2, 4E3, 4E4
		4E5, 4E6

CPU-EB or higher.

**NOTES:**

- After step 4, the display will show the line type previously assigned to the selected trunk group.
- Numbers 1 ~ 4 dialed in Step 5 correspond to the following line types:

- 1 - Second Dial Tone
- 2 - Immediate Start
- 3 - Delay Dial
- 4 - Wink Start

When assigning this parameter for E&M Tie Lines, type 1 ~ 4 are available. With DID trunks, only types 2 ~ 4 will apply. By default, the Second Dial Tone type is assigned.

- Depressing the ANS key will automatically return you to Step 3.

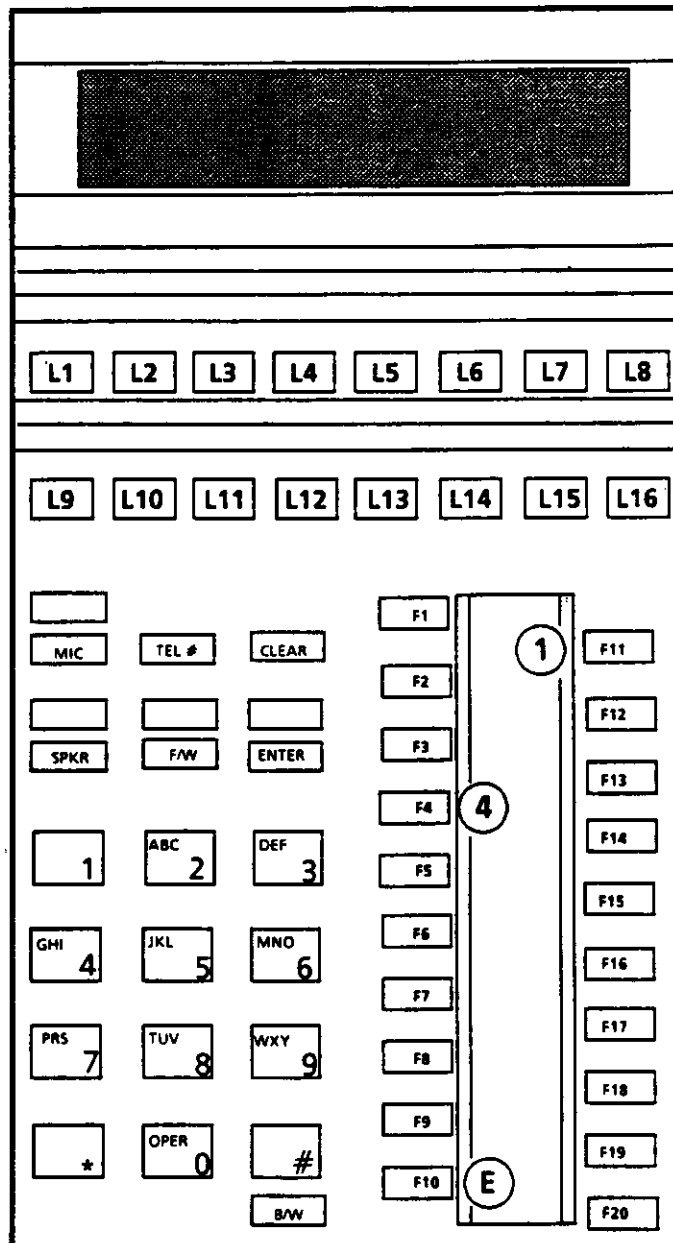

**GENERAL INFORMATION - TLI LINE TYPE ASSIGNMENT**

This area of the memory block is used to assign the method of loop supervision to be used for each of the Trunk Groups which are associated with TLI-E( ) ETUs.

## MEMORY BLOCK 4E2 - TLI DIAL TONE ASSIGNMENT

OPERATION      ← AND →      DISPLAY

1. Go off line.
 

	O	F	F	-	L	I	N	E		(	X	.	X	X	)
	P	R	O	G	R	A	M		M	O	D	E			
  
2. Depress F4, then F10.
 

T	L	I		P	R	O	G	R	A	M	M	I	N	G	
  
3. Depress F12.
 

D	I	A	L		T	O	N	E		A	S	S	I	G	N
T	R	U	N	K		G	R	O	U	P	?				
  
4. Dial the number of the Trunk Group (1 ~ 8) to be assigned. Example: Trunk Group 2. (See Note 1).
 

D	I	A	L		T	O	N	E		T	R	K	.	G	2
S	E	T		L	I	N	E		K	E	Y		1	-	2
  
5. Depress L1 and/or L2 to set desired parameters. (See Notes 2 & 4).
  
6. Depress ENTER key. (See Note 3).
 

D	I	A	L		T	O	N	E		A	S	S	I	G	N
T	R	U	N	K		G	R	O	U	P	?				
  
7. Repeat Steps 4 thru 6 for all Trunk Groups associated with TLI-E ( ) ETU's to be programmed.
  
8. Depress the SPKR key to go back on line

**KEY FUNCTION (OFF LINE)**

<b>SPKR</b> - ON/OFF Line
<b>TEL #</b> - Enters new Trunk Group number
<b>F/W</b> - Increments Trunk Group number
<b>CLEAR</b> -
<b>ENTER</b> - Enters each assignment
<b>B/W</b> - Decrements Trunk Group number

**GUIDE TO FEATURE PROGRAMMING**

MEMORY BLOCK BEING PROGRAMMED	MEMORY BLOCK THAT MUST BE PROGRAMMED	MEMORY BLOCK THAT MAY HAVE TO BE PROGRAMMED
<b>4E2</b>	2C1	4E1, 4E3, 4E4
		4E5, 4E6

CPU-EB or higher.

**NOTES:**

1. After a Trunk Group has been selected, L1 and L2 will show the previous assignment.
2. When the Trunk Group being programmed is comprised of DID trunks, do not send dial tone to either side.
3. Depressing the ANSWER key will automatically bring you to Step 3.

- |                      |   |                |                       |
|----------------------|---|----------------|-----------------------|
| 4. Distant End LED 1 | } | <u>ON</u>      | <u>OFF</u>            |
| System End LED 2     |   | Send Dial Tone | Do not Send Dial Tone |

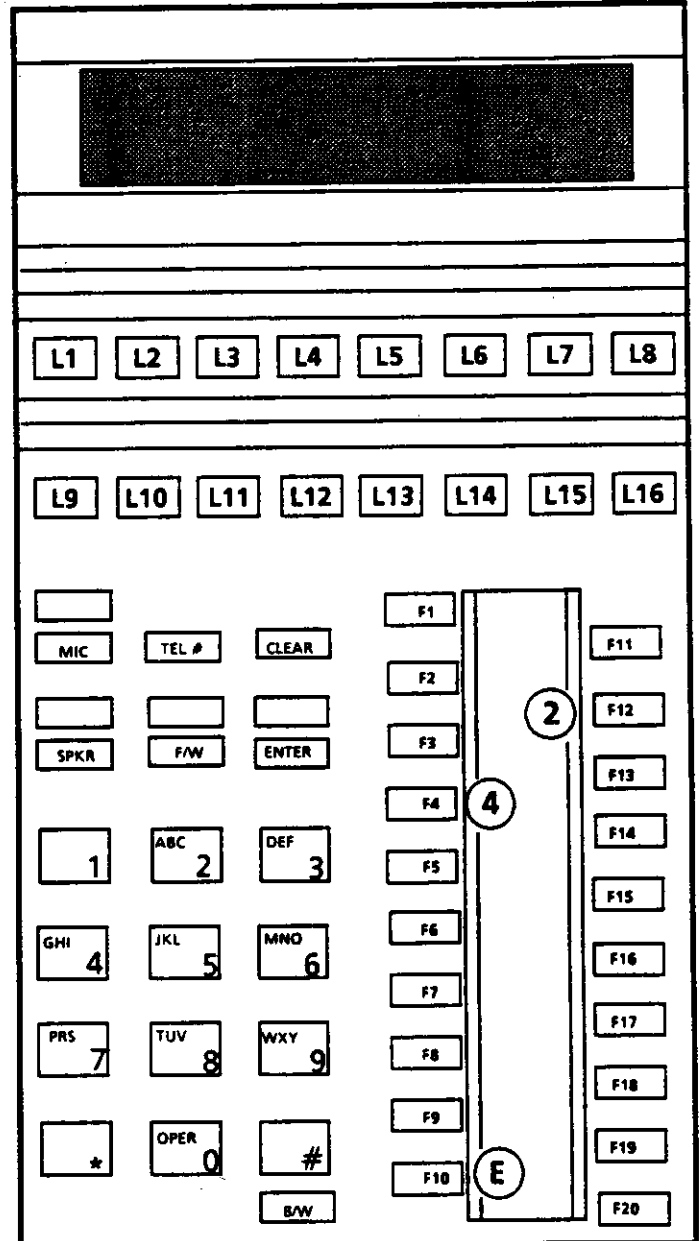

**GENERAL INFORMATION - TLI DIAL TONE ASSIGNMENT**

This area of the memory block is used to assign whether or not the Electra Mark II will provide dial tone to either side of a Tie line for each of the Trunk Groups which are associated with TLI-E( ) ETUs.

**MEMORY BLOCK 4E3 - TLI DIGIT ADD / DELETE CODE ASSIGNMENT**

OPERATION ← AND → DISPLAY

1. Go off line.

O	F	F	-	L	I	N	E		(	X	.	X	X	)
P	R	O	G	R	A	M		M	O	D	E			

2. Depress F4, then F10.

T	L	I		P	R	O	G	R	A	M	M	I	N	G

3. Depress F13.

A	D	D	/	D	E	L		C	O	D	E			
T	R	U	N	K		G	R	O	U	P	?			

4. Dial the number of the Trunk Group (1 ~ 8) to be assigned. Example: Trunk Group 3 (See Note 1.)

C	O	D	E		T	R	U	N	K		G	R	P	3
D	E	L	;	X		A	D	D	;	X	X	X		

5. Dial the number of digits to be deleted.  
 Example: 2 (See Note 2.)

C	O	D	E		T	R	U	N	K		G	R	P	3
D	E	L	;	2		A	D	D	;	X	X	X		

6. Dial the additional numbers to be added.  
 Example: 3 (See Note 3.)

C	O	D	E		T	R	U	N	K		G	R	P	3
D	E	L	;	2		A	D	D	;	3				

7. Depress ENTER key. (See Note 4.)

A	D	D	/	D	E	L		C	O	D	E			
T	R	U	N	K		G	R	O	U	P	?			

8. Repeat Steps 4 thru 7 for all Trunk Groups, associated with a TLI-E( ) ETU, to be programmed.

9. Depress the SPKR key to go back on line.



**KEY FUNCTION (OFF LINE)**

<b>SPKR</b> - ON/OFF Line
<b>TEL #</b> - Enters new Trunk Group number
<b>F/W</b> - Increments Trunk Group number
<b>CLEAR</b> - Clears previous assignment
<b>ENTER</b> - Enters each assignment
<b>B/W</b> - Decrements Trunk Group number

**GUIDE TO FEATURE PROGRAMMING**

MEMORY BLOCK BEING PROGRAMMED	MEMORY BLOCK THAT MUST BE PROGRAMMED	MEMORY BLOCK THAT MAY HAVE TO BE PROGRAMMED
<b>4E3</b>	2C1	4E1, 4E2, 4E4,
		4E5, 4E6

CPU-EB or higher.

**NOTES:**

1. During step 4, the display will show the previous assignment of the selected Trunk Group.
2. Depressing the # key on the dial pad during step 5 will clear the additional digits assignment on display.
3. Up to three (3) additional digits can be added up to three (3) digits can be deleted.
4. Depressing the ENTER key will automatically return you to step 3.

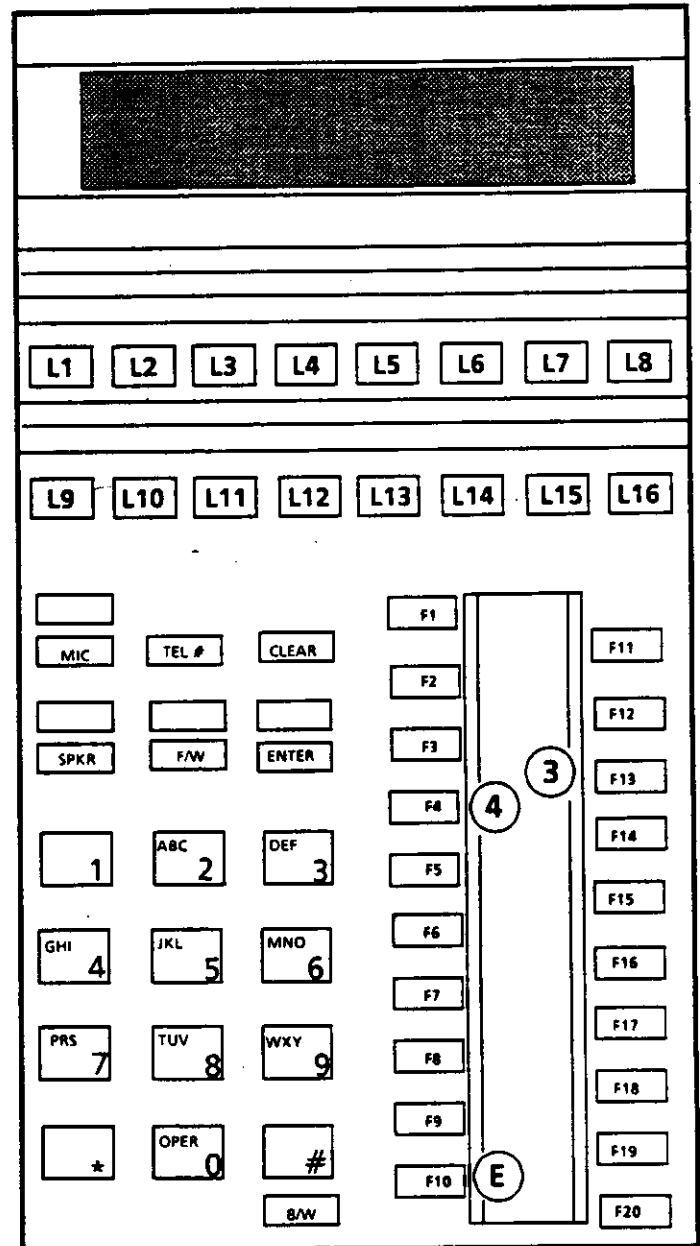

**GENERAL INFORMATION - TLI DIGIT ADD / DELETE CODE ASSIGNMENT**

This area of the memory block is used to delete and/or add up to three (3) digits for each of the Trunk Groups which are associated with TLI-E( ) ETUs. The purpose of adding and/or deleting digits is to facilitate the connection of DID trunks and Tie Lines to the system which are supported by TLI-E( ) ETUs.

**MEMORY BLOCK 4E4 - TLI - I INITIALIZED VALUES**

OPERATION      ← AND →      DISPLAY

1. Go off line.

O	F	F	-	L	I	N	E		(	X	.	X	X	)
P	R	O	G	R	A	M		M	O	D	E			

2. Depress F4, then F10.

T	L	I		P	R	O	G	R	A	M	M	I	N	G

3. Depress F14.

T	L	I		I	N	I	T	I	A	L	I	Z	E	1
T	R	U	N	K		G	R	O	U	P	?			

4. Dial the number of the Trunk Group (1 ~ 8) to be assigned. Example: Trunk Group 1. (See Note 1).

T	L	I		I	N	I	T	I	A	L	I	Z	E	1
T	R	U	N	K		G	R	O	U	P	1			

5. Depress L1 ~ L16 to set the required timing parameters to the selected Trunk Group. (See Note 2).

T	L	I		I	N	I	T	I	A	L	I	Z	E	1
T	R	U	N	K		G	R	O	U	P	1			

6. Depress ENTER key. (See Note 3).

T	L	I		I	N	I	T	I	A	L	I	Z	E	1
T	R	U	N	K		G	R	O	U	P	?			

7. Repeat steps 4 thru 7 for all Trunk Groups, associated with TLI-E( ) ETUs, to be programmed.

8. Depress the SPKR key to go back on line.

**KEY FUNCTION (OFF LINE)**

<b>SPKR</b> - ON/OFF Line
<b>TEL #</b> - Enters new Trunk Group number
<b>F/W</b> - Increments Trunk Group number
<b>CLEAR</b> -
<b>ENTER</b> - Enters each assignment
<b>B/W</b> - Decrements Trunk Group number

**GUIDE TO FEATURE PROGRAMMING**

MEMORY BLOCK BEING PROGRAMMED	MEMORY BLOCK THAT MUST BE PROGRAMMED	MEMORY BLOCK THAT MAY HAVE TO BE PROGRAMMED
<b>4E4</b>	2C1	4E1,4E2,4E3
		4E5,4E6,4C1

CPU-EB or higher.  
**NOTES:**

- After a trunk group has been selected, L1~L16 will show the previous assignments.
- Timing Parameters:

LINE BUTTONS				FUNCTION	
L5	L6	L7	L8	Pre-Pause time	IN SECS.
L1	L2	L3	L4	Pause time (500mS. x M)	
L9	L10	L11	L12	CO Answer Detect (130mS.x M)	
L13	L14	L15	L16	CO Release Detect (130mS.x M)	
				MULTIPLIER (M)	
0	0	0	0	0	0
0	0	0	1	1	0.5
0	0	1	0	2	1.0
0	0	1	1	3	1.5
0	1	0	0	4	2.0
0	1	0	1	5	3.0
0	1	1	0	6	4.0
0	1	1	1	7	5.0
1	0	0	0	8	6.0
1	0	0	1	9	7.0
1	0	1	0	10	8.0
1	0	1	1	11	9.0
1	1	0	0	12	10.0
1	1	0	1	13	11.0
1	1	1	0	14	12.0

- Depressing the ENTER key will automatically return you to step 3.

**GENERAL INFORMATION - TLI - I INITIALIZE VALUES**

This area of the memory block is used to assign various timing parameters, listed above, to each Trunk Group associated with TLI-E( ) ETUs.

The diagram shows a control panel with two rows of line buttons (L1-L8 and L9-L16). Below these are function buttons: MIC, TEL #, CLEAR, SPKR, F/W, ENTER, a numeric keypad (1-0, \*, #), and a B/W button. To the right is a vertical column of function keys F1-F20. A vertical bar with buttons 4 and E is positioned between the numeric keypad and the F1-F20 column.

**DEFAULTS:**

- Pre-Pause Time = 3 sec.
- Pause Time = 1 sec.
- CO Answer Detect = 520 msec.
- CO Release Detect = 520 msec.

**MEMORY BLOCK 4E5 - TLI - II INITIALIZED VALUES**

OPERATION      ←      AND      →      DISPLAY

1. Go off line.

	O	F	F	-	L	I	N	E		(	X	.	X	X	)
	P	R	O	G	R	A	M		M	O	D	E			

2. Depress F4, then F10.

T	L	I		P	R	O	G	R	A	M	M	I	N	G	

3. Depress F15.

T	L	I		I	N	I	T	I	A	L	I	Z	E	2	
T	R	U	N	K		G	R	O	U	P	?				

4. Dial the number of the Trunk Group (1 ~ 8) to be assigned. Example: Trunk Group 1. (See Note 1).

T	L	I		I	N	I	T	I	A	L	I	Z	E	2	
T	R	U	N	K		G	R	O	U	P	1				

5. Depress L1~L16 to set the required timing parameters to the selected trunk group. (See Note 2).

T	L	I		I	N	I	T	I	A	L	I	Z	E	2	
T	R	U	N	K		G	R	O	U	P	1				

6. Depress ENTER key. (See Note 3).

T	L	I		I	N	I	T	I	A	L	I	Z	E	2	
T	R	U	N	K		G	R	O	U	P	?				

7. Repeat steps 4 thru 7 for all trunk groups, associated with TLI-E( ) ETUs, to be programmed.

8. Depress the SPKR key to go back on line.

**KEY FUNCTION (OFF LINE)**

<b>SPKR</b> - ON/OFF Line
<b>TEL #</b> - Enters new Trunk Group number
<b>F/W</b> - Increments Trunk Group number
<b>CLEAR</b> -
<b>ENTER</b> - Enters each assignment
<b>B/W</b> - Decrements Trunk Group number

**GUIDE TO FEATURE PROGRAMMING**

MEMORY BLOCK BEING PROGRAMMED	MEMORY BLOCK THAT MUST BE PROGRAMMED	MEMORY BLOCK THAT MAY HAVE TO BE PROGRAMMED
<b>4E5</b>	2C1	4E1,4E2,4E3
		4E4,4E6

CPU-EB or higher.

**NOTES:**

- After a trunk group has been selected, L1~L16 will show the previous assignments.
- Timing Parameters:

LINE BUTTONS				FUNCTION	
L1	L2	L3	L4		
				Loop Off-Guard Time	IN SECS.
				Wink Delay Incoming Detection Time	
				Length of Wink Signal (30 mS x M) + 30 mS	
				Length of Delay Signal 300 mS x M	
				MULTIPLIER (M)	
0	0	0	0	0	0
0	0	0	1	1	0.5
0	0	1	0	2	1.0
0	0	1	1	3	1.5
0	1	0	0	4	2.0
0	1	0	1	5	3.0
0	1	1	0	6	4.0
0	1	1	1	7	5.0
1	0	0	0	8	6.0
1	0	0	1	9	7.0
1	0	1	0	10	8.0
1	0	1	1	11	9.0
1	1	0	0	12	10.0
1	1	0	1	13	11.0
1	1	1	0	14	12.0

- Depressing the ENTER key will automatically return you to step 3.

**GENERAL INFORMATION - TLI - II INITIALIZE VALUES**

This area of the memory block is used to assign various timing parameters, listed above, to each Trunk Group associated with TLI-E( ) ETUs.

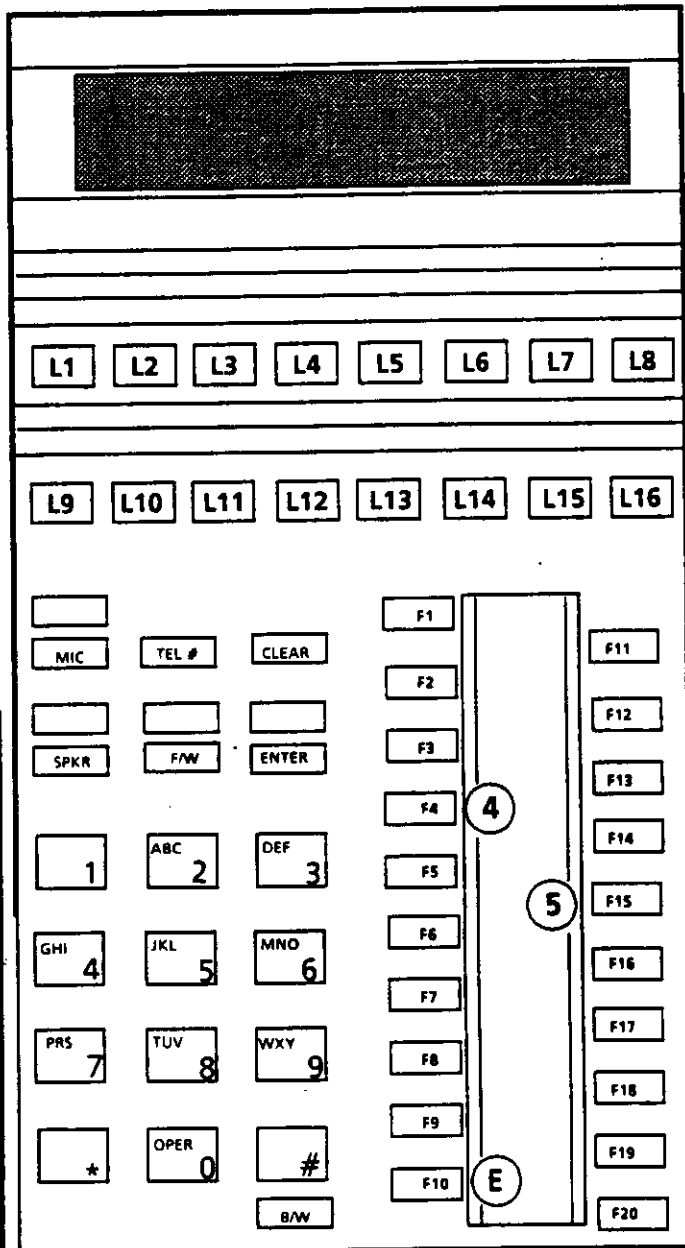

**DEFAULTS:**

- Incoming Detection Time:
- Wink Start = 130 mS. x M. (Default 520 mS.)
- Delay Dialing = 30 mS. x M (Default 120 mS.)
- Loop Off Guard = 0~12 secs. (Default 2 secs.)
- Length of Wink Signal = 30 mS.x M) + 30 mS. (Default 180 mS.)
- Length of Delay Signal = 300mS.x M (Default 300 mS.)

## MEMORY BLOCK 4E6 - TLI - III INITIALIZED VALUES

OPERATION ← AND → DISPLAY

1. Go off line.

	O	F	F	-	L	I	N	E		(	X	.	X	X	)
	P	R	O	G	R	A	M		M	O	D	E			

2. Depress F4, then F10.

T	L	I		P	R	O	G	R	A	M	M	I	N	G	

3. Depress F16.

T	L	I		I	N	I	T	I	A	L	I	Z	E	3	
T	R	U	N	K		G	R	O	U	P	?				

4. Dial the number of the Trunk Group (1 ~ 8) to be assigned. Example: Trunk Group 4. (See Note 1.)

T	L	I		I	N	I	T	I	A	L	I	Z	E	3	
T	R	U	N	K		G	R	O	U	P	4				

5. Depress L1 ~ L8 and L13 ~ L16 to set the required timing parameters to the selected Trunk Group. (See Note 2.)

T	L	I		I	N	I	T	I	A	L	I	Z	E	3	
T	R	U	N	K		G	R	O	U	P	4				

6. Depress ENTER key. (See Note 3.)

T	L	I		I	N	I	T	I	A	L	I	Z	E	3	
T	R	U	N	K		G	R	O	U	P	?				

7. Repeat steps 4 thru 7 for all Trunk Groups, associated with TLI-E( ) ETUs, to be programmed.

8. Depress the SPKR key to go back on line.

**KEY FUNCTION (OFF LINE)**

SPKR - ON/OFF Line
TEL # - Enters new Trunk Group number
F/W - Increments Trunk Group number
CLEAR -
ENTER - Enters each assignment
B/W - Decrements Trunk Group number

**GUIDE TO FEATURE PROGRAMMING**

MEMORY BLOCK BEING PROGRAMMED	MEMORY BLOCK THAT MUST BE PROGRAMMED	MEMORY BLOCK THAT MAY HAVE TO BE PROGRAMMED
<b>4E6</b>	2C1	4E1,4E2,4E3
		4E4,4E5,

CPU-EB or higher.

**NOTES:**

- After a trunk group has been selected, L1~L8 and L13~L16 will show the previous assignments. L9~L12 may be lit and can be changed in status, however, they perform no function at this time.
- Timing Parameters:

LINE BUTTONS				FUNCTION		
L13	L14	L15	L16	Tandem Restriction / LCR Control Timer		
L5	L6	L7	L8	Outgoing Guard Time		
L1	L2	L3	L4	Timeout for Wink/Delay Signal Detector		
				IN SECS.	IN SECS.	IN SECS.
0	0	0	0	∞	0.02	∞
0	0	0	1	1	1	2
0	0	1	0	2	2	4
0	0	1	1	3	3	6
0	1	0	0	4	4	8
0	1	0	1	5	5	10
0	1	1	0	6	6	12
0	1	1	1	7	7	14
1	0	0	0	8	8	16
1	0	0	1	9	9	18
1	0	1	0	9	10	20
1	0	1	1	9	11	22
1	1	0	0	9	12	24
1	1	0	1	9	13	26
1	1	1	0	9	14	28

- Depressing the ENTER key will automatically return you to step 3.
- Outgoing Guard Time must be assigned less than 10 seconds.
- Outgoing Guard Timer can be used for Loop Dial Tie Lines only.
- E&M Tie Lines have a fixed outgoing Guard Time of 20 msec.

**GENERAL INFORMATION - TLI - III INITIALIZE VALUES**

This area of the memory block is used to assign various timing parameters, listed above, to each Trunk Group associated with TLI-E ( ) ETUs.

### MEMORY BLOCK 4E7 - TLI-IV INITIALIZED VALUES

OPERATION ← AND → DISPLAY

1. Go off line.
 

	O	F	F	-	L	I	N	E		(	X	.	X	X	)
	P	R	O	G	R	A	M		M	O	D	E			
  
2. Depress F4, then F10.
 

T	L	I		P	R	O	G	R	A	M	M	I	N	G	
  
3. Depress F17.
 

T	L	I		I	N	I	T	I	A	L	I	Z	E	4	
M	O	D	?		S	L	O	T	*		C	H	*		
  
4. Dial CCU module number (1 ~ 4) where TLI port being assigned is located.  
 Example: Module 1.
 

T	L	I		I	N	I	T	I	A	L	I	Z	E	4	
M	O	D	1		S	L	O	T	?		C	H	*		
  
5. Dial CCU slot number (1 ~ 8) where TLI port is being assigned. Example: Slot 5.
 

T	L	I		I	N	I	T	I	A	L	I	Z	E	4	
M	O	D	1		S	L	O	T	5		C	H	?		
  
6. Dial TLI channel number (1 ~ 2) of TLI port to be assigned. Example: Channel 1.
 

T	L	I		I	N	I	T	I	A	L	I	Z	E	4	
M	O	D	1		S	L	O	T	5		C	H	1		
  
7. Depress L1 to L16 to set the desired pad parameters (See Note 1). Corresponding LEDs go on or off accordingly.
8. Depress ENTER key (See Note 2).
 

T	L	I		I	N	I	T	I	A	L	I	Z	E	4	
M	O	D	1		S	L	O	T	5		C	H	2		
  
9. Repeat steps 4 thru 8 for all trunks associated with TLI-E( ) ETUs to be programmed, or depress TEL # to program a specific TLI-E( ) port.
10. Depress the SPKR key to go back on line.



**KEY FUNCTION (OFF LINE)**

<b>SPKR</b> - ON/OFF line
<b>TEL #</b> - Selects TLI port number
<b>F/W</b> - Increments TLI port number
<b>CLEAR</b> -
<b>ENTER</b> - Enters pad loss assignment
<b>B/W</b> - Decrements TLI port number

**GUIDE TO FEATURE PROGRAMMING**

MEMORY BLOCK BEING PROGRAMMED	MEMORY BLOCK THAT MUST BE PROGRAMMED	MEMORY BLOCK THAT MAY HAVE TO BE PROGRAMMED
<b>4E7</b>		<b>4C1</b>

LINE BUTTONS				FUNCTION	
L1	L2	L3	L4	RECEIVE - INTERNAL	
L5	L6	L7	L8	TRANSMIT - INTERNAL	
L9	L10	L11	L12	RECEIVE - EXTERNAL	
L13	L14	L15	L16	TRANSMIT - EXTERNAL	
				CODE	dB LOSS
0	0	0	0	0	2
0	0	0	1	1	4
0	0	1	0	2	6
0	0	1	1	3	8
0	1	0	0	4	12
0	1	0	1	5	16
0	1	1	0	6	0
0	1	1	1	7	0
1	0	0	0	8	0

CPU-EB2 or higher.

**NOTES:**

- 1. Pad Definitions:**  
**Internal** = dB loss between Tie line and distant station.  
**External** = dB loss between Tie line and distant trunk.  
**Default** = 2dB for Internal and External.
- 2. Depressing the ENTER key causes the display to increment to the next channel, or the first channel of the next slot with a TLI-E ( ) installed.**

**GENERAL INFORMATION - TLI - IV INITIALIZED VALUES**

This area of the memory block is used to assign attenuation levels to software controlled pads used in the Tie lines between the local station and a distant station or a distant trunk. These loss levels are independent of, and are additive, to the loss levels controlled by switches located on the TLI cards.

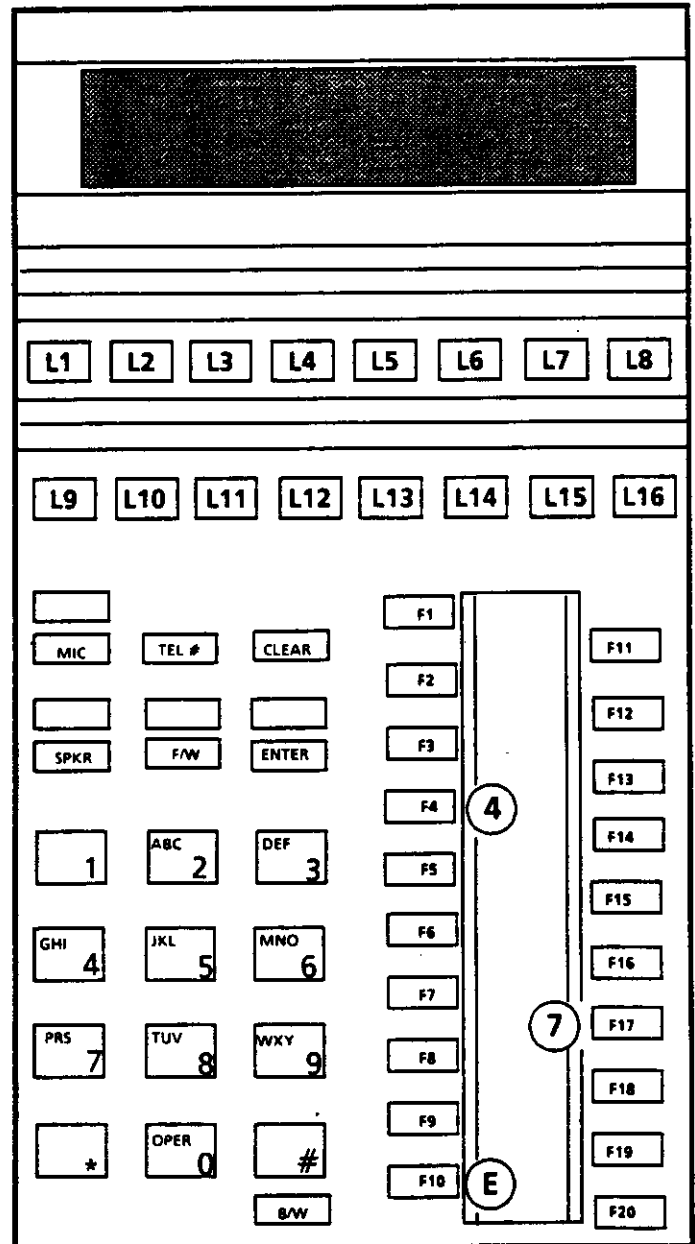

## MEMORY BLOCK 4E8 - TLI-V INITIALIZED VALUES

OPERATION ← AND → DISPLAY

1. Go off line.
 

O	F	F	-	L	I	N	E		(	X	.	X	X	)
P	R	O	G	R	A	M		M	O	D	E			
  
2. Depress F4, then F10.
 

T	L	I		P	R	O	G	R	A	M	M	I	N	G
  
3. Depress F18.
 

T	L	I		I	N	I	T	I	A	L	I	Z	E	5
M	O	D	?		S	L	O	T	*		C	H	*	
  
4. Dial CCU module number (1 ~ 4) where the TLI port to be programmed is located.  
 Example: Module 1.
 

T	L	I		I	N	I	T	I	A	L	I	Z	E	5
M	O	D	1		S	L	O	T	?		C	H	*	
  
5. Dial CCU slot number (1 ~ 8) where TLI port is to be programmed. Example: Slot 5.
 

T	L	I		I	N	I	T	I	A	L	I	Z	E	5
M	O	D	1		S	L	O	T	5		C	H	?	
  
6. Dial TLI channel number (1 ~ 2) of TLI port to be assigned.  
 Example: Channel 1.
 

T	L	I		I	N	I	T	I	A	L	I	Z	E	5
M	O	D	1		S	L	O	T	5		C	H	1	
  
7. Depress L1 to L12 to set the desired DTMF parameters of the selected TLI port (See Note 1).  
 Corresponding LED(s) go on or off accordingly.
  
8. Depress ENTER key. (See Note 2).
 

T	L	I		I	N	I	T	I	A	L	I	Z	E	5
M	O	D	1		S	L	O	T	5		C	H	2	
  
9. Repeat steps 4 thru 8 for all trunks associated with TLI-EB ETUs to be programmed.
  
10. Depress the SPKR key to go back on line.

**KEY FUNCTION (OFF LINE)**

<b>SPKR</b> - ON/OFF Line
<b>TEL #</b> - Selects TLI port number
<b>F/W</b> - Increments channel number
<b>CLEAR</b> -
<b>ENTER</b> - Enters each assignment
<b>B/W</b> - Decrements channel number

**GUIDE TO FEATURE PROGRAMMING**

MEMORY BLOCK BEING PROGRAMMED	MEMORY BLOCK THAT MUST BE PROGRAMMED	MEMORY BLOCK THAT MAY HAVE TO BE PROGRAMMED
<b>4E8</b>		4C1

CPU-EB2 or higher.

**NOTES:**

- During step 7, the status of L1 ~ L12 indicates the previous parameters set to the Tie line chosen:  
 L1~L4 = DTMF Interdigit Time  
 10 ms. + (40 mS.x M) (M=0~14)  
 Default = 70 msec.  
 L5~L8 = DTMF Duration Time  
 50 ms. + (60 mS.x M) (M=0~14)  
 Default = 110 msec.

LINE BUTTONS				FUNCTION
L1	L2	L3	L4	DTMF Interdigit Time (40 mS x M) + 10 mS
L5	L6	L7	L8	DTMF Duration Time (60 mS x M) + 50 mS
				MULTIPLIER (M)
0	0	0	0	0
0	0	0	1	1
0	0	1	0	2
0	0	1	1	3
0	1	0	0	4
0	1	0	1	5
0	1	1	0	6
0	1	1	1	7
1	0	0	0	8
1	0	0	1	9
1	0	1	0	10
1	0	1	1	11
1	1	0	0	12
1	1	0	1	13
1	1	1	0	14

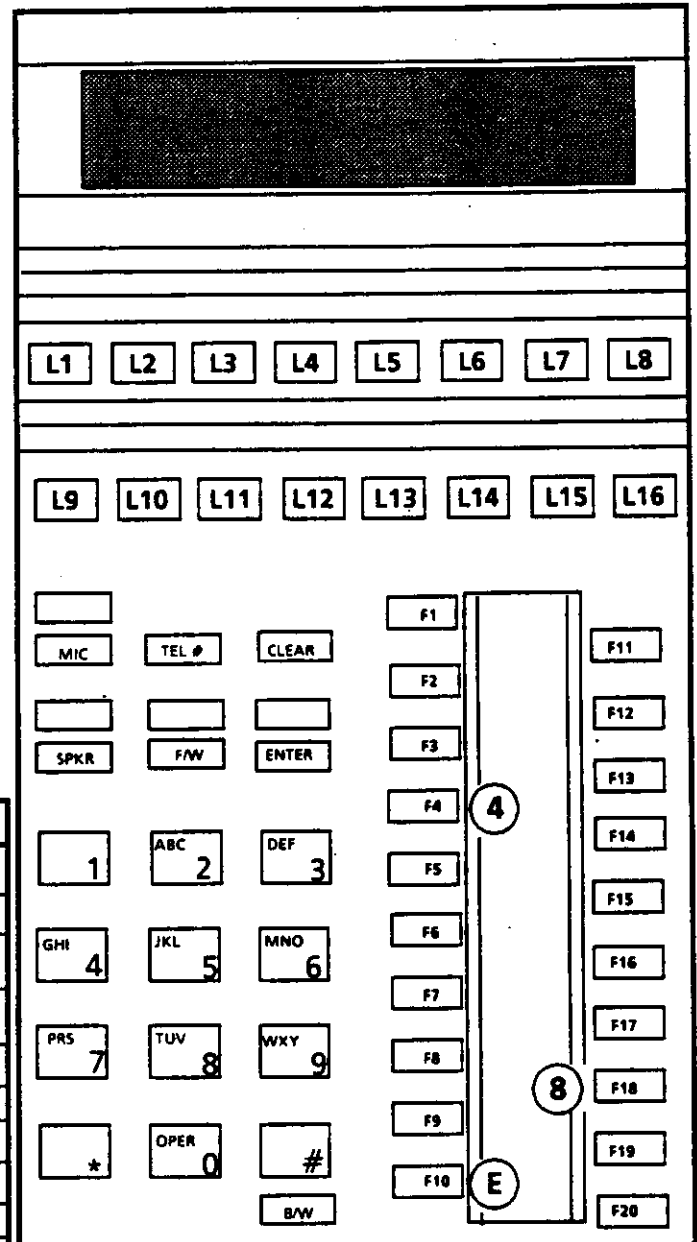

L9	L10	TRANSMIT
0	0	NOT USED
0	1	DP
1	0	DTMF
1	1	NOT USED

L11	L12	RECEIVE
0	0	NOT USED
0	1	DP
1	0	DTMF
1	1	DP/DTMF

0 = OFF    1 = ON

- Depressing the ENTER key causes the display to increment to the next Tie Line channel.

**GENERAL INFORMATION - TLI - V INITIALIZED VALUES**

This area of the memory block is used to assign DTMF parameters for TIE lines.

# MEMORY BLOCK 4E9 - TANDEM PORT TO HUNT GROUP ASSIGNMENT

OPERATION ← AND → DISPLAY

1. Go off line.

	O	F	F	-	L	I	N	E		(	X	.	X	X	)
	P	R	O	G	R	A	M			M	O	D	E		

2. Depress F4, then F10.

T	L	I		P	R	O	G	R	A	M	M	I	N	G	

3. Depress F19.

T	A	N	D	E	M		P	O	R	T		A	S	G	N
E	X	T	?	?	?										

4. Enter the extension number to be assigned to the Tandem Port Hunt Group. Example: 300. (See Notes 2, 6, & 7).

T	A	N	D	E	M		P	O	R	T		A	S	G	N
E	X	T	3	0	0		-		H	U	N	T	.	G	?

5. Enter the Tandem Port Hunt Group number to be assigned to the chosen port (1 ~ 8). Example: Hunt Group 2.

T	A	N	D	E	M		P	O	R	T		A	S	G	N
E	X	T	3	0	0		-		H	U	N	T	.	G	2

6. Depress ENTER key. (See Note 8).

T	A	N	D	E	M		P	O	R	T		A	S	G	N
E	X	T	?	?	?										

7. Repeat Steps 4 and 5 to assign all Tandem Ports required.

8. Depress SPKR key to go back on line.

**KEY FUNCTION (OFF LINE)**

<b>SPKR</b> - ON/OFF line
<b>TEL #</b> - Enters extension number
<b>F/W</b> - Increments extension number
<b>CLEAR</b> - Clears previous Hunt Group assignment
<b>ENTER</b> - Enters Hunt Group assignment
<b>B/W</b> - Decrements extension number

**GUIDE TO FEATURE PROGRAMMING**

MEMORY BLOCK BEING PROGRAMMED	MEMORY BLOCK THAT MUST BE PROGRAMMED	MEMORY BLOCK THAT MAY HAVE TO BE PROGRAMMED
<b>4E9</b>	<b>1E2</b>	<b>4C1, 4E10</b>

CPU-EB2 or higher.

**NOTES:**

1. Tandem switching uses software ports assigned as ETE-16D-( ) stations. These ports require no supporting hardware to function, but they must be assigned as follows:  
 Assign an ESI card to an unused slot (4C1). The corresponding port numbers are automatically assigned by the system. Program these slots as ETE-16D-( ) phantom terminals (1E2).
2. Ports associated with any type of installed, working stations, cannot be assigned Tandem Ports.
3. Maximum Tandem Ports = 20
4. Tandem Port default = None
5. Maximum Tandem Port Hunt Groups = 8
6. Virtual extensions cannot be assigned to a tandem port hunt group.
7. During step 4, any current Tandem Port hunt group assigned for the Tandem Port chosen is displayed.
8. Depressing the ENTER key causes the display to go to step 3.

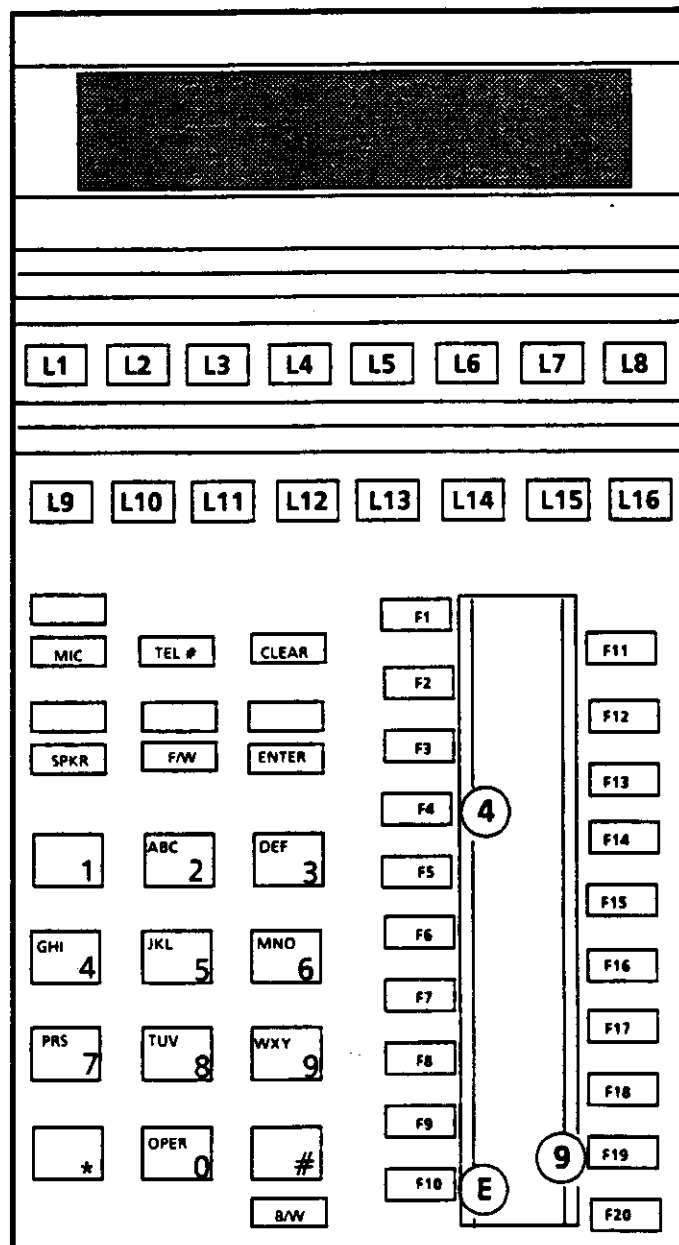

**GENERAL INFORMATION - TANDEM PORT TO HUNT GROUP ASSIGNMENT**

This area of the memory block is used to assign software Tandem Ports into Hunt Groups. When a tandem connection is being processed, the system will search for an idle Phantom Tandem Port within the corresponding Hunt Group.

## MEMORY BLOCK 4E10 - TRUNK GROUP TO TANDEM HUNT GROUP ASSIGNMENT

OPERATION ← AND → DISPLAY

1. Go off line.
 

	O	F	F	-	L	I	N	E		(	X	.	X	X	)
	P	R	O	G	R	A	M			M	O	D	E		
  
2. Depress F4, then F10.
 

T	L	I		P	R	O	G	R	A	M	M	I	N	G	
  
3. Depress F20.
 

T	A	N	D	E	M		H	U	N	T		A	S	G	N
T	R	K	.	G	?										
  
4. Enter the Trunk Group number to be assigned (1 ~ 8). Example: Trunk group 2.
 

T	A	N	D	E	M		H	U	N	T		A	S	G	N
T	R	K	.	G	2		-		H	U	N	T	.	G	X
  
5. Enter the Tandem Hunt Group number to be assigned to the chosen Trunk Group (1 ~ 8). Example: Hunt Group 2. (See Note 1).
 

T	A	N	D	E	M		P	O	R	T		A	S	G	N
T	R	K	.	G	2		-		H	U	N	T	.	G	2
  
6. Depress ENTER key. (See Note 2).
 

T	A	N	D	E	M		P	O	R	T		A	S	G	N
T	R	K	.	G	3		-		H	U	N	T	.	G	X
  
7. Repeat Steps 5 and 6 to assign all Trunk Groups required, or depress TEL # to assign a specific trunk group.
8. Depress SPKR key to go back on line.

**KEY FUNCTION (OFF LINE)**

SPKR - ON/OFF Line
TEL # - Enters Trunk Group number
F/W - Increments Trunk Group number
CLEAR -
ENTER - Enters each assignment
B/W - Decrements Trunk Group number

**GUIDE TO FEATURE PROGRAMMING**

MEMORY BLOCK BEING PROGRAMMED	MEMORY BLOCK THAT MUST BE PROGRAMMED	MEMORY BLOCK THAT MAY HAVE TO BE PROGRAMMED
4E10		4E9

CPU-EB2 or higher.

**NOTES:**

1. By default, all trunk groups (1 ~ 8) are assigned to Tandem Hunt Group 1.
2. Depressing the ENTER key causes the display to increment to the next Trunk Group.

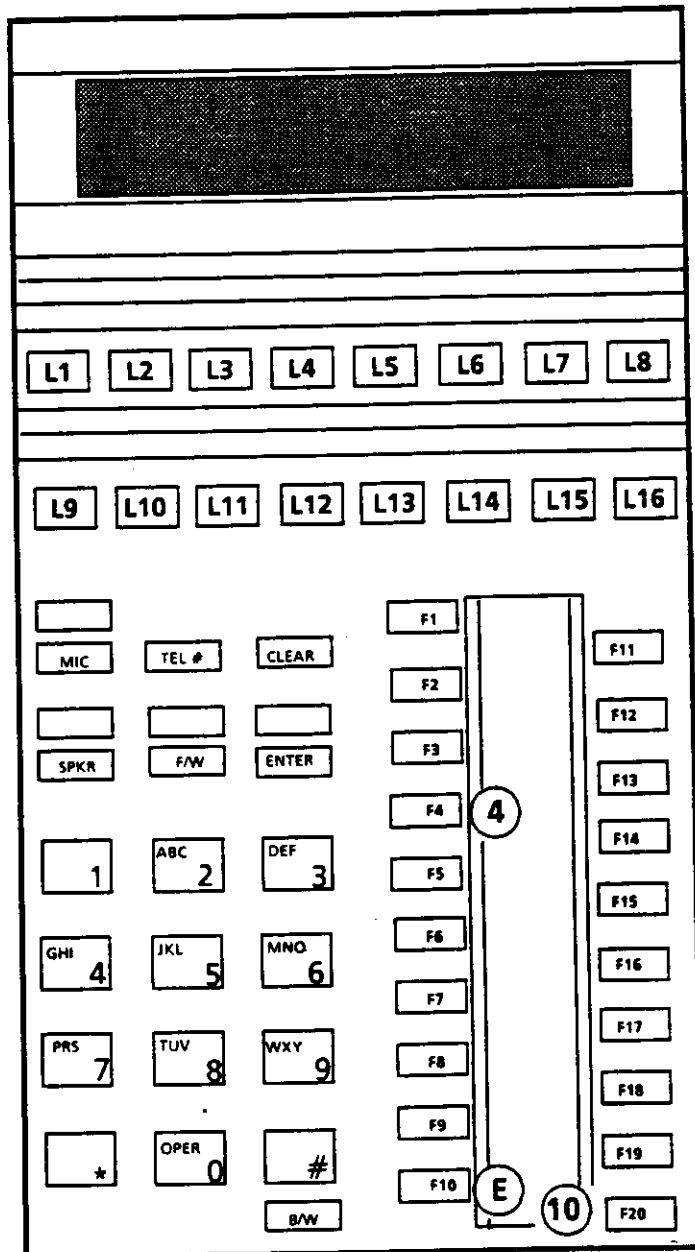

**GENERAL INFORMATION - TRUNK GROUP TO TANDEM HUNT GROUP ASSIGNMENT**

This area of the memory block is used to assign Trunk Groups to Tandem Hunt Groups. Different Trunk Groups may be assigned the same Hunt Group.

# MEMORY BLOCK 5A - STATION COPY ASSIGNMENT

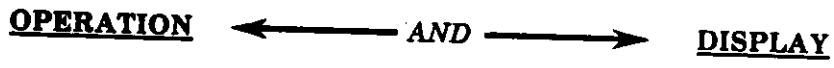

The feature to be copied must be shown in the display before entering copying mode.  
 Example: Ringing assignment on Station 104.

R	I	N	G					D	A	Y	M	O	D	E
T	E	L	1	0	4									

1. Depress F5.

C	O	P	Y											

3. Depress F6.

R	I	N	G	/	D					#	1	0	4	
S	T	A	R	T	?	?	?	E	N	D	*	*	*	

4. Dial the station number to be copied.  
 Example: Station 105.

R	I	N	G	/	D					#	1	0	4	
S	T	A	R	T	1	0	5	E	N	D	?	?	?	

5. Dial the last (highest) station number to be copied.  
 Example: Station 125.

R	I	N	G	/	D					#	1	0	4	
S	T	A	R	T	1	0	5	E	N	D	1	2	5	

6. Depress ENTER key. (See Notes 1 and 2).

R	I	N	G					D	A	Y	M	O	D	E
T	E	L	1	0	5									

7. Depress the SPKR key to go back on line.



**KEY FUNCTION (OFF LINE)**

SPKR - ON/OFF Line
TEL # -
F/W -
CLEAR -
ENTER - Copy
B/W -

**GUIDE TO FEATURE PROGRAMMING**

MEMORY BLOCK BEING PROGRAMMED	MEMORY BLOCK THAT MUST BE PROGRAMMED	MEMORY BLOCK THAT MAY HAVE TO BE PROGRAMMED
<b>5A</b>		

All CPU levels.

**NOTES:**

1. Depressing the ENTER key will cause the feature assigned to the station identified in step 1 to be copied to all stations between the lowest and highest station (inclusive) defined.
2. After the ENTER key is depressed, the display will return to the feature from step 1 with the station number incremented by one.

3. The following memory blocks are the only memory blocks that can be copied using this feature:

- 1A Line Key Assignment  
(Not S&R, SE or PE)
- 1B Ringing Assignment (Day & Night)
- 1C3 DSS Button Assignment  
(Feature and Station Appearance)
- 1C4 Flexible Function Key Assignment
- 1D1 Prime/Ringing Line Assignment
- 1D4 Trunk Group Incoming Restriction
- 1D5 Trunk Group Outgoing Restriction
- 1D6 Code Restriction Table Access
- 1D7 Class of Service
- 1D8 Station to Attendant Assignment

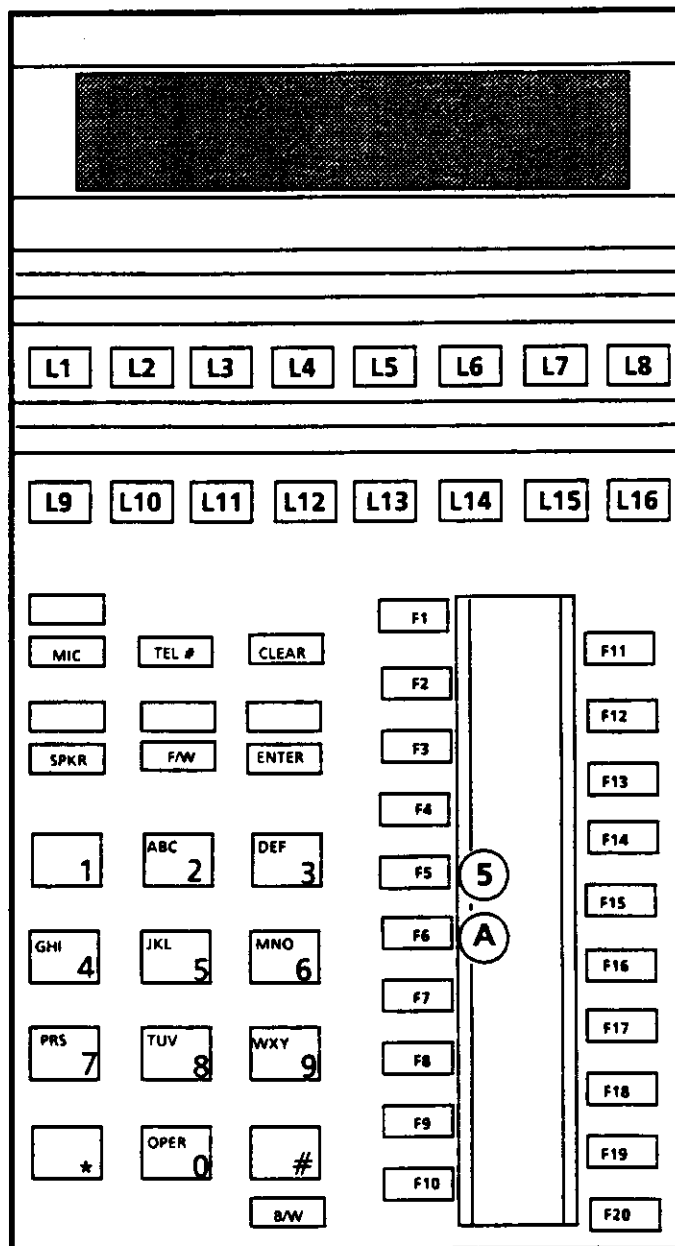

**GENERAL INFORMATION - STATION COPY ASSIGNMENT**

This area of the memory block is used to copy the assignment of one station to as many stations as desired in one step. This greatly reduces programming time by allowing the repetitious assignments to be copied instead of using the individual programming steps.

### MEMORY BLOCK 5B1 - CPU INITIAL HISTORY

OPERATION ← AND → DISPLAY

1. Go off line.

O	F	F	-	L	I	N	E		(	X	.	X	X	)
P	R	O	G	R	A	M		M	O	D	E			

2. Depress F5.

		M	A	I	N	T	E	N	A	N	C	E		

3. Depress F7.

		M	A	I	N	T	E	N	A	N	C	E	1	

4. Depress F11. (See Notes 2 and 3).

	C	P	U		I	N	I	T	I	A	L	.	0	1
0	9	:	1	4	J	A	N	2	2	-	8	8	T	1

5. If the history is not to be cleared, proceed to step 8.

6. To clear the history, Depress CLEAR key.

	C	P	U		I	N	I	T	I	A	L	.	0	1
	C	L	E	A	R		D	A	T	A		?		

7. Depress ENTER key. (See Note 2).

	C	P	U		I	N	I	T	I	A	L	.	0	1
			V	A	C	A	N	T						

8. Depress SPKR key to go back on line.

**KEY FUNCTION (OFF LINE)**

<b>SPKR</b> - ON/OFF Line
<b>TEL #</b> - Selects the latest events of Initial History
<b>F/W</b> - Increment Initial History event number
<b>CLEAR</b> - Selects Initial History clear mode
<b>ENTER</b> - Enters Initial History clear
<b>B/W</b> - Decrements Initial History event number

**GUIDE TO FEATURE PROGRAMMING**

MEMORY BLOCK BEING PROGRAMMED	MEMORY BLOCK THAT MUST BE PROGRAMMED	MEMORY BLOCK THAT MAY HAVE TO BE PROGRAMMED
<b>5B1</b>		

**CPU-EB3 or higher  
 NOTES**

1. During step 4 when the F/W or B/W key is depressed, the Initial History event number is incremented or decremented.

C	P	U	.	I	N	I	T	I	A	L	.	0	1	
0	9	:	1	4	J	A	N	2	2	-	8	8	T	1

F/W ↓ ↑ B/W

C	P	U	.	I	N	I	T	I	A	L	.	0	2	
0	8	:	3	1	J	A	N	0	4	-	8	8	T	2

2. Up to the ten latest Initial History events can be referenced.
3. T1 ~ T5 are Initial History codes.

History Code	Initial History Description
T1	System hardware reset or a forced initialization has occurred.
T2	Automatic initialization due to system error has occurred.
T3	Automatic initialization due to system error has occurred.
T4	There were "Power Off" conditions.
T5	There were "Main Program" (ROM) replacements (enhancements, upgrades, etc.).

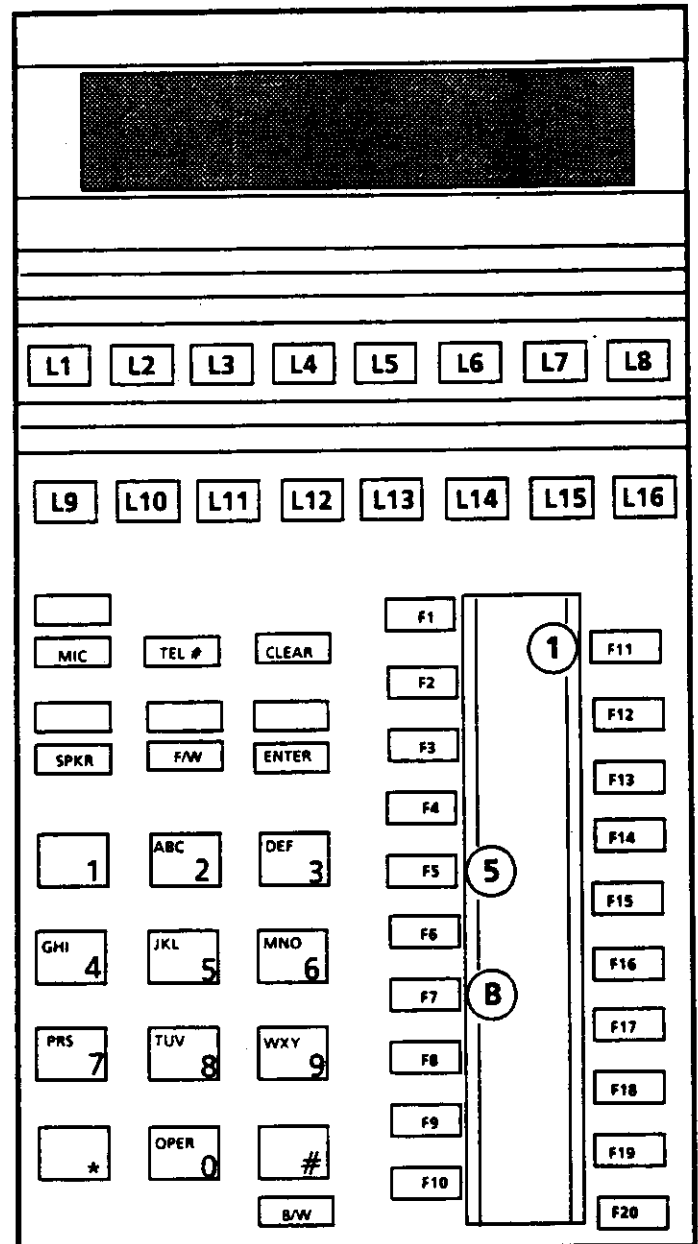

**GENERAL INFORMATION - CPU INITIAL HISTORY**

This area of the memory block is used to refer to the CPU's Initial History.

## MEMORY BLOCK 5B2 - SYSTEM PROGRAM CHECK

OPERATION ← AND → DISPLAY

1. Go off line.
 

	O	F	F	-	L	I	N	E		(	x	.	x	x	)
	P	R	O	G	R	A	M			M	O	D	E		
  
2. Depress F5, then F7.
 

		M	A	I	N	T	E	N	A	N	C	E	1		
  
3. Depress F12.
  - (1) Case of Error
 

S	Y	S	.		P	R	O	G	.		C	H	E	C	K
					"	E	R	R	O	R	"				

" " : Flashing
  - (2) Case of No Error
 

S	Y	S	.		P	R	O	G	.		C	H	E	C	K
		N	O		E	R	R	O	R						
  
4. Depress L1~L5 to display the program error count.  
 Example: L2  
 (See Note 2).
 

S	Y	S	.		P	R	O	G	.		C	H	E	C	K
		P	R	O	G	R	A	M		2	-	x	x	x	
  
5. If the counter value is not to be cleared, proceed to Step 8.
  
6. Depress CLEAR key.
 

S	Y	S	.		P	R	O	G	.		C	H	E	C	K
		C	L	E	A	R		D	A	T	A		?		
  
7. Depress ENTER key. (See Note 3).
 

S	Y	S	.		P	R	O	G	.		C	H	E	C	K
		V	A	C	A	N	T								
  
8. Depress SPKR key to go back on line.

**KEY FUNCTION (OFF LINE)**

<b>SPKR</b> - ON/OFF Line
<b>TEL #</b> - Selects new program error information
<b>F/W</b> - Increments program number
<b>CLEAR</b> - Clears all program errors
<b>ENTER</b> - Enters the clear command
<b>B/W</b> - Decrements program number

**GUIDE TO FEATURE PROGRAMMING**

MEMORY BLOCK BEING PROGRAMMED	MEMORY BLOCK THAT MUST BE PROGRAMMED	MEMORY BLOCK THAT MAY HAVE TO BE PROGRAMMED
<b>5B2</b>		

CPU-EB3 or higher.

**NOTES:**

- During step 2, L1 to L5 correspond to programs 1 to 5 respectively and will show program status.  
 Red LED flashers = Error  
 LED OFF = No Error
- During step 3 the LCD bottom row xxx will show the number of program errors. Up to 255 errors may be displayed.
- When the clear operation is performed, all error counts for programs 1 to 5 are cleared.
- Program number and EPROM number correspondence.

PROGRAM NO.	EPROM NO.
1	ROM 00 & 01
2	ROM 02, 03, 04, 05, 06 & 07
3	ROM 06, 07, 08, & 09
4	ROM 08, 09, 10, 11, 12 & 13
5	ROM 12 & 13

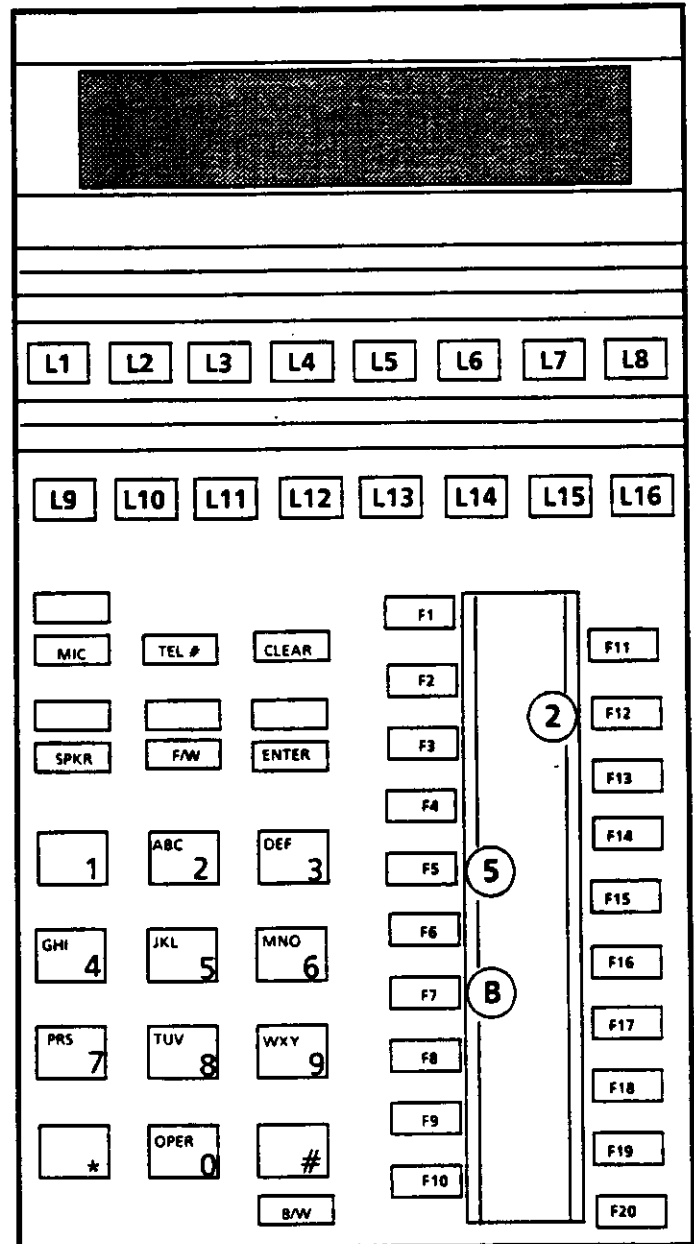

**GENERAL INFORMATION - SYSTEM PROGRAM CHECK**

This area of the memory block is used to refer to the System Program Status.

## MEMORY BLOCK 5B3 - INTERFACE SLOT CHECK

OPERATION ← AND → DISPLAY

1. Go off line.
 

O	F	F	-	L	I	N	E		(	X	.	X	X	)
P	R	O	G	R	A	M		M	O	D	E			
  
2. Depress F5, then F7.
 

		M	A	I	N	T	E	N	A	N	C	E	1	
  
3. Depress 13.
 

I	N	T	E	R	F	A	C	E		C	H	E	C	K
M	O	D	U	L	E	?			S	L	O	T	*	
  
4. Dial module number (1~4) of the slot to be checked.  
 Example: Module 1
 

I	N	T	E	R	F	A	C	E		C	H	E	C	K
M	O	D	U	L	E	1			S	L	O	T	?	
  
5. Dial slot number (1~8) for the required slot.  
 Example: Slot 5  
 (See Note 1.)
 

I	N	T	E	R	F	A	C	E		C	H	E	C	K	
	M	O	D	1		S	L	O	T	5		-	X	X	X
  
6. If the counter value is not to be cleared, proceed to Step 9.
  
7. Depress CLEAR key.
 

I	N	T	E	R	F	A	C	E		C	H	E	C	K	
	M	O	D	1		S	L	O	T	5		-	0	0	0
  
8. Depress ENTER key. (See Note 2).
 

I	N	T	E	R	F	A	C	E		C	H	E	C	K	
	M	O	D	1		S	L	O	T	6		-	X	X	X
  
9. Depress SPKR key to go back on line.

**KEY FUNCTION (OFF LINE)**

<b>SPKR</b> - ON/OFF Line
<b>TEL #</b> - Selects new Interface Slot information
<b>F/W</b> - Increments the Interface Slot number
<b>CLEAR</b> - Clears Interface Slot check information
<b>ENTER</b> - Enters the clear command
<b>B/W</b> - Decrements the Interface Slot number

**GUIDE TO FEATURE PROGRAMMING**

MEMORY BLOCK BEING PROGRAMMED	MEMORY BLOCK THAT MUST BE PROGRAMMED	MEMORY BLOCK THAT MAY HAVE TO BE PROGRAMMED
<b>5B3</b>		

CPU-EB3 or higher.

**NOTES:**

1. During step 5, the ETU error count is displayed as xxx on the bottom row of the LCD. Up to 255 errors can be displayed.
2. After depressing the CLEAR key and then the ENTER key, the number of interface errors is cleared.

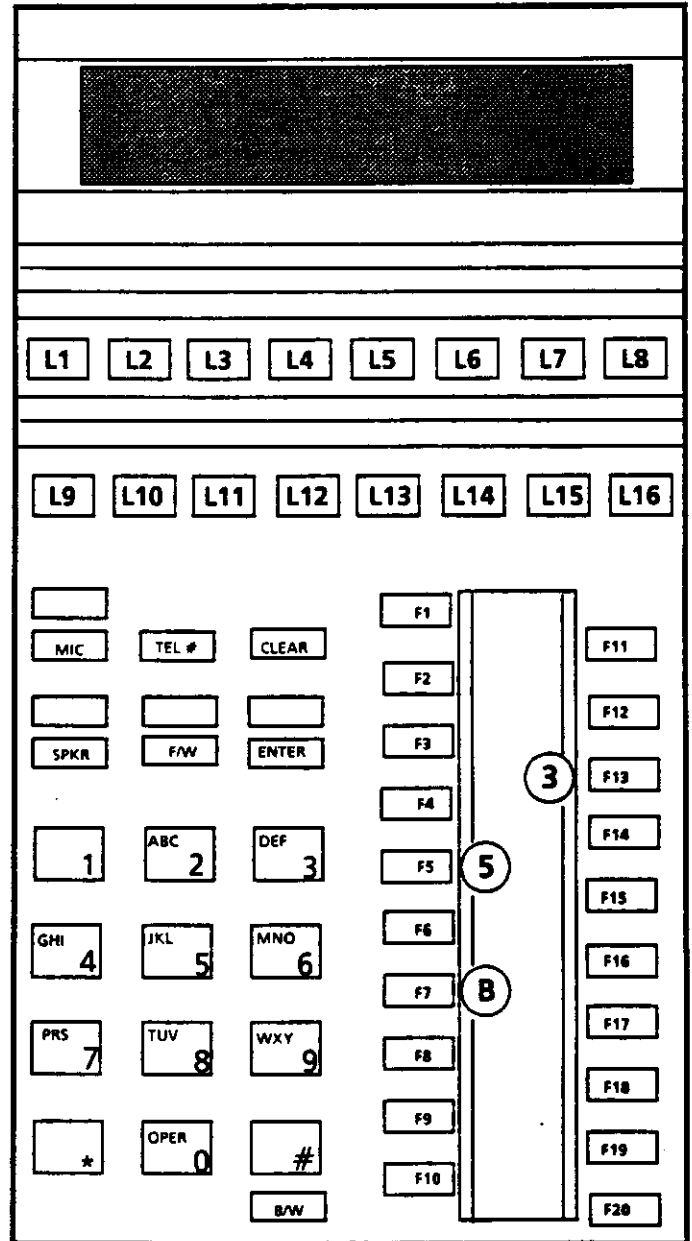

**GENERAL INFORMATION - INTERFACE SLOT CHECK**

This area of the memory block is used to record erroneous PRWs. An erroneous PRW will also register when the ETU busy out switch is turned off. Every time an ETU is busy out, the particular error counter is incremented by 1.

### MEMORY BLOCK 5B4 - TERMINAL CHECK

OPERATION ← AND → DISPLAY

1. Go off line.
 

O	FF	-	L	I	N	E		(	X	.	X	X	)
P	R	O	G	R	A	M		M	O	D	E		
  
2. Depress F5, then F7.
 

		M	A	I	N	T	E	N	A	N	C	E	1		
  
3. Depress F14 (See Note 1).
 

		T	E	R	M	I	N	A	L		C	H	E	C	K
T	E	L	?	?	?										
  
4. To determine Telephone/Port Number assignment, dial station number to be referenced.  
 Example: Station 120 (See Note 2).
 

		C	H	E	C	K				T	E	L	1	2	0
E	R	R	O	R		C	O	U	N	T			x	x	x
  
5. To determine DSS/Port assignment, depress L14.
 

O	P	E	.		T	E	R	M		C	H	E	C	K	
D	S	S	?												
  
6. Enter DSS device number (1~6). Example 6.
 

		C	H	E	C	K					D	S	S		6
E	R	R	O	R		C	O	U	N	T			x	x	x
  
7. To determine device type associated with a particular port, depress L15.
 

O	P	E	.		T	E	R	M		C	H	E	C	K	
M	O	D	?		S	L	O	T	*		C	H	*		
  
8. Enter module slot, and channel number.  
 Example: Module 1 Slot 3 Channel 2.
 

		C	H	E	C	K		M	1	,	S	3	,	C	H	2
E	R	R	O	R		C	O	U	N	T				x	x	x
  
9. If the counter value is not to be cleared, proceed to Step 12.
  
10. Depress CLEAR key.
 

		C	H	E	C	K				T	E	L	1	2	0
E	R	R	O	R		C	O	U	N	T			0	0	0
  
11. Depress ENTER key. (See Note 2).
 

		C	H	E	C	K				T	E	L	1	2	1
E	R	R	O	R		C	O	U	N	T			x	x	x
  
12. Depress SPKR key to go back on line.



**KEY FUNCTION (OFF LINE)**

<b>SPKR</b> - ON/OFF Line
<b>TEL #</b> - Selects new port device information
<b>F/W</b> - Increments port device number
<b>CLEAR</b> - Clears error count number
<b>ENTER</b> - Enters the clear command
<b>B/W</b> - Decrements port device number

**GUIDE TO FEATURE PROGRAMMING**

MEMORY BLOCK BEING PROGRAMMED	MEMORY BLOCK THAT MUST BE PROGRAMMED	MEMORY BLOCK THAT MAY HAVE TO BE PROGRAMMED
<b>5B4</b>		

CPU-EB3 or higher.

**NOTES:**

1. During step 3, the terminal error count device is displayed as xxx on the bottom row of the LCD. Up to 255 errors can be displayed.
2. After depressing the CLEAR key and then the ENTER key, the number of terminal errors are cleared.

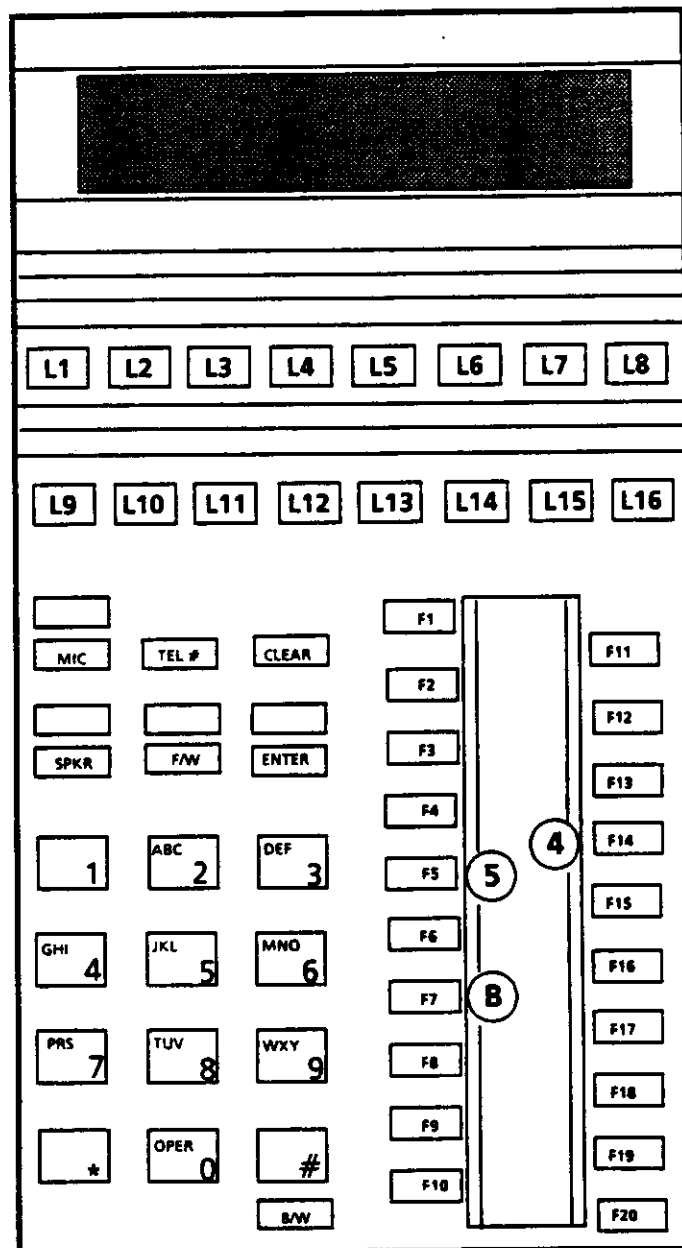

**GENERAL INFORMATION - TERMINAL CHECK**

This area of the memory block is used to record erroneous PRW's of port devices including ESI-EA and ESI-EB ETUs.

This information checks whether the communication between each terminal and its corresponding interface card is stable. An erroneous PRW will also register when the terminal is unplugged.

### MEMORY BLOCK 5B5 - SOFTWARE/HARDWARE SLOT STATUS

OPERATION ← AND → DISPLAY

1. Go off line.

	O	F	F	-	L	I	N	E		(	X	.	X	X	)
	P	R	O	G	R	A	M		M	O	D	E			

2. Depress F5, F7.

	M	A	I	N	T	E	N	A	N	C	E	1			

3. Depress F15.

S	/	H		S	L	O	T		S	T	A	T	U	S	
M	O	D	U	L	E	?			S	L	O	T	*		

4. Dial module number of the slot to be referenced (1~4).  
 Example: Module 1

S	/	H		S	L	O	T		S	T	A	T	U	S	
M	O	D	U	L	E	1			S	L	O	T	?		

5. Dial slot number to be referenced (1~8).  
 Example: Slot 5  
 (See Note 1 and 2).

S	/	H		-		M	O	D	1		S	L	O	T	5
S	:	x	x	x	x			H	:	y	y	y	y		

6. Depress SPKR key to go back on line.

**KEY FUNCTION (OFF LINE)**

SPKR - ON/OFF Line
TEL # - Select new slot information
F/W - Increments slot number
CLEAR -
ENTER -
B/W - Decrements slot number

**GUIDE TO FEATURE PROGRAMMING**

MEMORY BLOCK BEING PROGRAMMED	MEMORY BLOCK THAT MUST BE PROGRAMMED	MEMORY BLOCK THAT MAY HAVE TO BE PROGRAMMED
5B5		

CPU-EB3 or higher.

**NOTES:**

- The xxxx display at the bottom row of the LCD is the software slot assignment type and yyyy is the hardware slot (installed card) type.

Card type	LCD display			
COI	C	O	I	•
TLI	T	L	I	•
SLI	S	L	I	•
MFR-EA	M	F	R	A
CNF	C	N	F	•
VMI	V	M	I	•
ESI-EA	E	S	I	A
ESI-EB	E	S	I	B
ECR	E	C	R	•

- When a slot is not installed or assigned, "NON" is displayed.
- If the hardware slot type is different from the software one, the hardware slot card does not work.
  - i.e. Software card type: the type that has been recognized by the main software presently.
  - Hardware card type: the type which is presently installed.

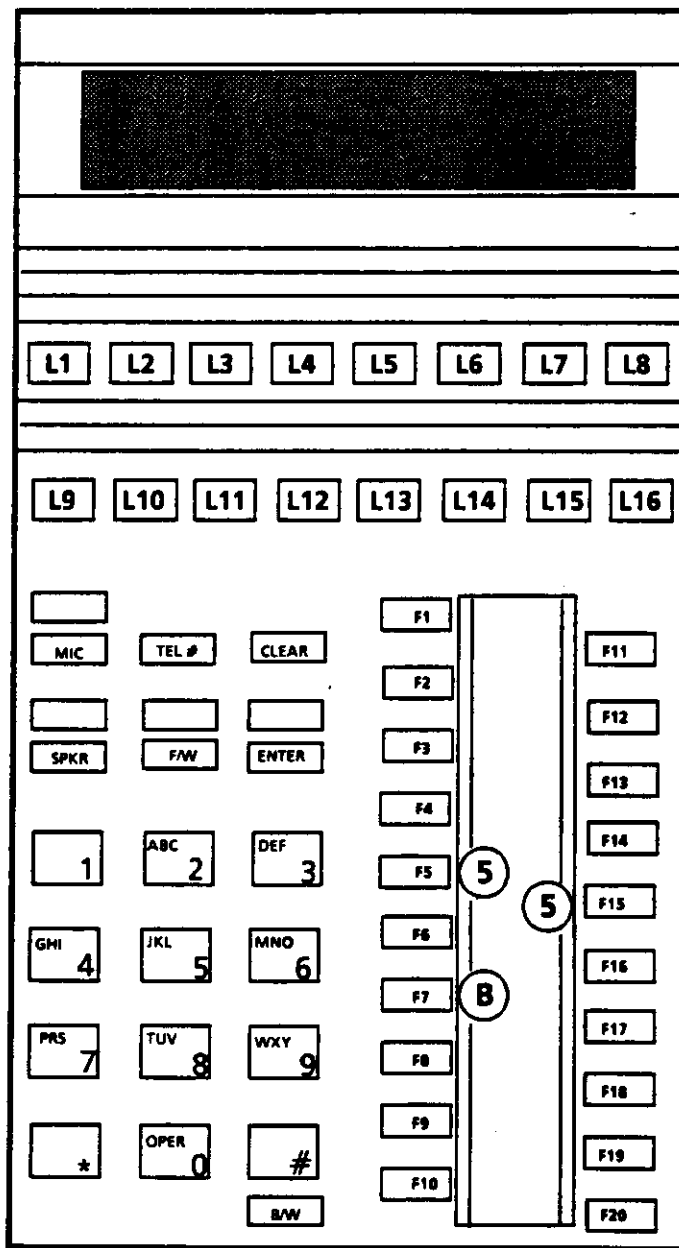

If you want to change the software card type, you can reassign it by system programming. (4C-1 Card Interface Slot Assignment).

**GENERAL INFORMATION - SOFTWARE/HARDWARE SLOT STATUS**

This area of the memory block is used to display software/hardware information for each ETU.

**MEMORY BLOCK 5B6 - SOFTWARE/HARDWARE TERMINAL**

OPERATION ← AND → DISPLAY

1. Go off line.

	O	F	F	-	L	I	N	E		(	X	.	X	X	)
	P	R	O	G	R	A	M		M	O	D	E			

2. Depress F5, then F7.

		M	A	I	N	T	E	N	A	N	C	E	1		

3. Depress F16 (See Note 1).

S	/	H		T	E	R	M		S	T	A	T	U	S	
T	E	L	?	?	?										

4. To determine Telephone/Port assignment dial station number to be referenced.  
 Example: Station 120 (See Notes 1 and 2).

S	/	H		T	E	R	M		T	E	L	1	2	0	
S	:	x	x	x	x				H	:	y	y	y	y	

5. To determine DSS/Port assignment, depress L14.

S	/	H		T	E	R	M		S	T	A	T	U	S	
D	S	S	?												

6. Enter DSS device number (1~6).

S	/	H		T	E	R	M				D	S	S	6	
S	:	x	x	x	x				H	:	y	y	y	y	

7. To determine device type associated with a particular port, depress L15.

S	/	H		T	E	R	M		S	T	A	T	U	S	
M	O	D	?			S	L	O	T	*		C	H	*	

8. Enter module, slot and channel number.  
 Example: Module 1 - Slot 3 - Channel 2.

S	/	H							M	1	,	S	3	,	C	H	2
S	:	x	x	x	x				H	:	y	y	y	y			

9. Depress SPKR key to go back on line.

**KEY FUNCTION (OFF LINE)**

SPKR - ON/OFF Line
TEL # - Select new terminal information
F/W - Increments terminal number
CLEAR -
ENTER -
B/W - Decrements terminal number

**GUIDE TO FEATURE PROGRAMMING**

MEMORY BLOCK BEING PROGRAMMED	MEMORY BLOCK THAT MUST BE PROGRAMMED	MEMORY BLOCK THAT MAY HAVE TO BE PROGRAMMED
5B6		

CPU-EB3 or higher.

**NOTES:**

- The xxxx display at the bottom row of the LCD is the software terminal assignment type and yyyy is the hardware port (installed terminal) type.
- When a terminal is not installed or assigned at the corresponding port, NON is displayed.

Terminal type	LCD display	Terminal type	LCD display
16D	1 6 D	16K	1 6 K
6D	6 D	DSS	D S S
6	6	RAA	R A A
16E	1 6 E	SLT	S L T

- If the hardware terminal type is different from the software one, the terminal does not work.

i.e. Software terminal Type: the type which main software recognizes.

Hardware terminal type: the type which is presently installed.

If you want to change the software terminal type, you can reassign it by system programming. (1E-2 Terminal Add Port)

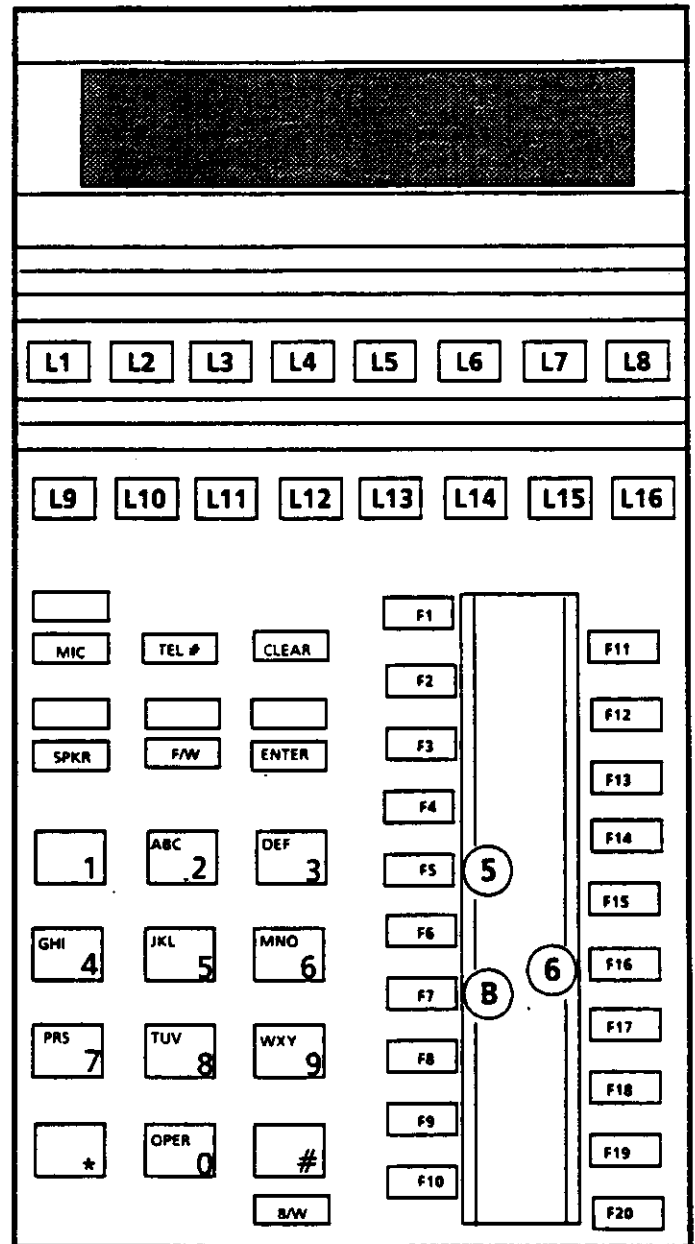

**GENERAL INFORMATION - SOFTWARE/HARDWARE TERMINAL STATUS**

This area of the memory block is used to display information of software/hardware terminal type.

**MEMORY BLOCK 5C1 - SYSTEM DATA LAST CHANGE**

OPERATION ← AND → DISPLAY

1. Go off line.

O	F	F	-	L	I	N	E		(	X	.	X	X	)
P	R	O	G	R	A	M			M	O	D	E		

2. Depress F5, and F8.

		M	A	I	N	T	E	N	A	N	C	E	2		

3. Depress F11. (See Note 1).

S	Y	S	.		D	A	T	A		C	H	A	N	G	E
0	3	:	1	2	J	A	N	2	2		1	A	-	0	4

4. Depress SPKR key to go back on line.

**KEY FUNCTION (OFF LINE)**

SPKR - ON/OFF Line
TEL # -
F/W -
CLEAR -
ENTER -
B/W -

**GUIDE TO FEATURE PROGRAMMING**

MEMORY BLOCK BEING PROGRAMMED	MEMORY BLOCK THAT MUST BE PROGRAMMED	MEMORY BLOCK THAT MAY HAVE TO BE PROGRAMMED
5C1		

CPU-EB3 or higher.

**NOTES:**

- During step 3, displayed time and memory block number is the last time and memory block number the Answer key was depressed, except when the Error Tone was heard.

0 3 : 1 2 J A N 2 2 1 A - 0 4

Hour, minute    Month    Day    Memory DSS Button  
Block    Depressed

DSS BUTTON	DSS BUTTON DEPRESSED INDICATIONS	FUNCTION
11	01	CO Line
12	02	Pool Line
14	04	EXT Line
16	06	Data XMIT
17	07	Data Receive
18	08	Save & Repeat
20	0:	DND Position

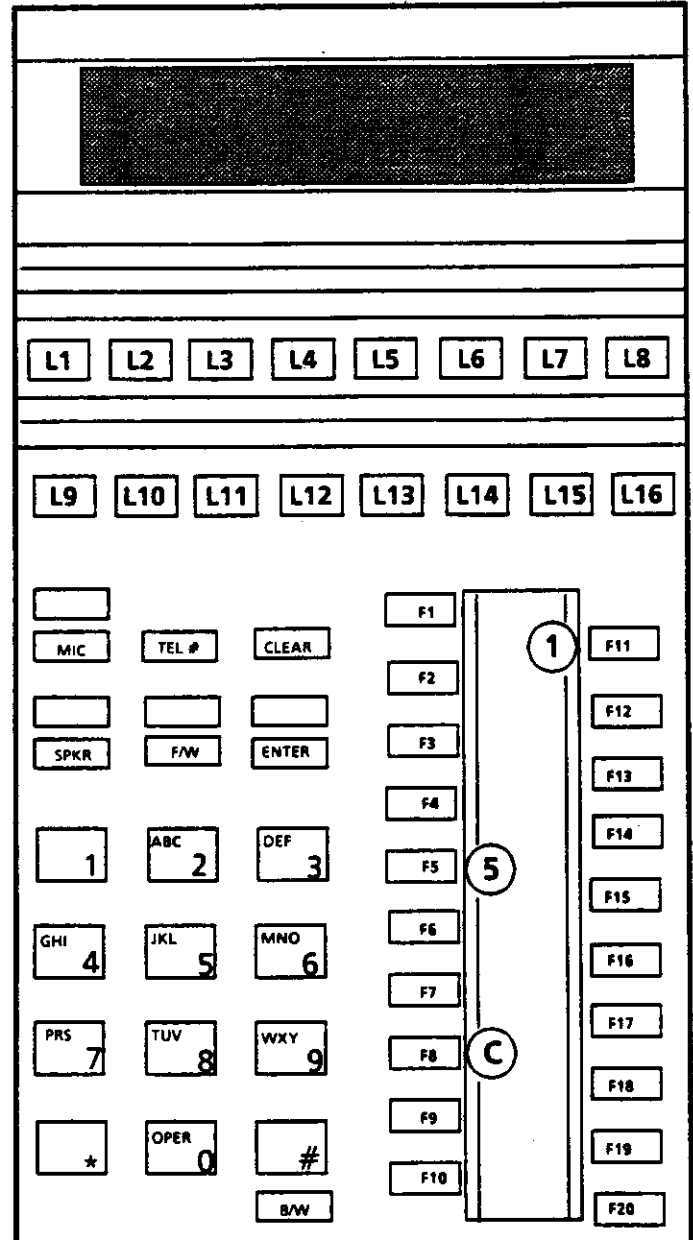

**GENERAL INFORMATION - SYSTEM DATA LAST CHANGE**

This area of the memory block is used to display information about the last system data change. This includes Time, Date, and Memory Block.

**MEMORY BLOCK 5C2 - DATA DUMP**

OPERATION ← AND → DISPLAY

1. Go off line.

	O	F	F	-	L	I	N	E		(	X	.	X	X	)
	P	R	O	G	R	A	M		M	O	D	E			

2. Depress F5, F8, and F12, in order.

	A	D	D	R	E	S	S			D	A	T	A		
	0	0	0	0	0	0	0								

3. Depress L1~L16 for setting the desired address to be referred.  
 Example: Address 400000  
 (See Notes 1 and 2).

	A	D	D	R	E	S	S			D	A	T	A		
	4	0	0	0	0	0	0								

4. Depress ENTER key. (See Notes 3 and 4).

	A	D	D	R	E	S	S			D	A	T	A		
			4	0	0	0	0	0				x	x		

5. Depress SPKR key to go back on line.



**KEY FUNCTION (OFF LINE)**

<b>SPKR</b> - ON/OFF Line
<b>TEL #</b> - Refer to new address
<b>F/W</b> - Increment address
<b>CLEAR</b> - Changes displayed data size
<b>ENTER</b> - Enter displayed data mode
<b>B/W</b> - Decrement address

**GUIDE TO FEATURE PROGRAMMING**

MEMORY BLOCK BEING PROGRAMMED	MEMORY BLOCK THAT MUST BE PROGRAMMED	MEMORY BLOCK THAT MAY HAVE TO BE PROGRAMMED
<b>5C2</b>		

CPU-EB3 or higher.

**NOTES:**

1. Line key and Address Correspondence.

LK No.	1	2	3	4	5	6	7	8	9	10	11	12	13	14	15	16
Add No.	1	2	3	4	5	6	7	8	9	A	B	C	D	E	F	0

2. The displayed Address is shifted to the left.

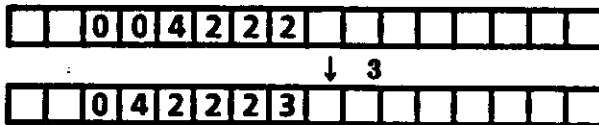

3. During step 4 when the ENTER key is depressed, the data corresponding to the address is displayed.
4. Each time the CLEAR key is depressed, the displayed data size is changed.  
1 byte → 4 bytes → 6 bytes → 8 bytes → 1 byte.

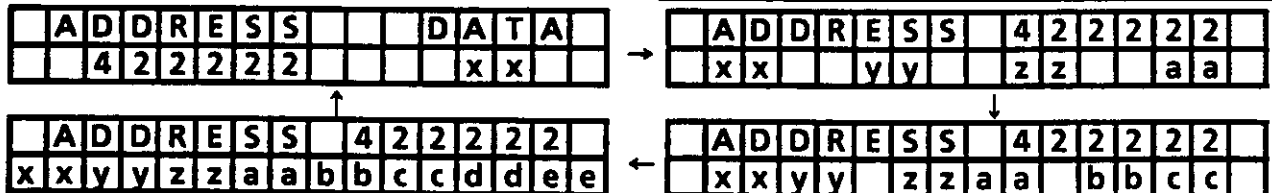

**GENERAL INFORMATION - DATA DUMP**

This area of the memory block is used to display the system's memory.  
This facility is useful for diagnostics and remote maintenance service in the event of system's trouble.

## SECTION 350 FUNCTION TIMER CHART

TIMER	MEMORY BLOCK	DEFINITION	TIMING VALUE		
			Minimum	Default	Maximum
Call Park Recall	2D-1	Time before a call placed in call park recalls. (except conference call)	10 sec.	180 sec.	990 sec.
Delay Announce Timeout	2D-1	Time Delay before Delay Announcement stops and the trunk is released.	10 sec.	600 sec.	Infinite
Start Time (SMDR) and Elapsed Call Timer	2D-1	Delay Time before system starts recording the duration of an outgoing call.	10 sec.	20sec.	70 sec.
DSS/BLF Camp-On/Transfer	2D-1	Recall timing for a call, back to the attendant station, after a DSS/BLF <i>Transfer</i> or <i>Camp-On</i> is unanswered.	10 sec.	50 sec.	990 sec.
Recall (Camp-On/Transfer/Non-Exclusive Hold)	2D-1	Recall timing for any call from a non-attendant position after a <i>Camp-On</i> , <i>Transfer</i> or a call placed on <i>Non-Exclusive Hold</i> is unanswered.	10 sec.	50 sec.	990 sec.
Cancel Automatic Callback	2D-1	Timeout value for a callback that goes unanswered.	10 sec.	20 sec.	990 sec.
Call Forward No Answer	2D-1	Time before a call forwards after no answer.	10 sec.	20 sec.	990 sec.
Exclusive Hold Recall	2D-1	Time before a call placed on <i>Exclusive Hold</i> recalls.	10 sec.	60 sec.	990 sec.
External Page Access Duration	2D-1	Allowed time for <i>External Page</i>	10 sec.	300 sec.	990 sec.
Internal Page Access Duration	2D-1	Allowed time for <i>Internal Page</i> .	10 sec.	60 sec.	990 sec.
Modem Reserve Timer	2D-1	Maximum time a modem within a modem pool can be reserved by a station.	10 sec.	600 sec.	990 sec.
SMDR Valid Call Timer	2D-1	Minimum duration of an outside call before the system provides an SMDR report.	10 sec.	40 sec.	990 sec.
Conference Park Recall	2D-1	Time before a conference call placed in call park recalls.	10 sec.	300 sec.	990 sec.
MFR Timeout	2D-2	Maximum time MFR will remain on line before the first and between each digit dialed by a Single Line Telephone.	1 sec.	10 sec.	99 sec.

**SECTION 350**  
**FUNCTION TIMER CHART (Contd.)**

TIMER	MEMORY BLOCK	DEFINITION	TIMING VALUE		
			Minimum	Default	Maximum
Talk Start Timer	2D-2	Minimum time needed after dialing on a trunk to establish a trunk to trunk transfer.	1 sec.	18 sec.	99 sec.
Delayed Ringing (CO Line)	2D-2	Time Delay before CO ringing starts at stations assigned delayed ringing.	1 sec.	15 sec.	99 sec.
Delayed Ringing (Extension)	2D-2	Time Delay before Internal ringing starts at stations assigned delayed ringing.	1 sec.	10 sec.	99 sec.
Voice Mail Automatic Dial Send Start	2D-2	Delay time before DTMF dial is sent to the VMI ports.	1 sec.	2 sec.	99 sec.
Delay Announce Timeout	2D-1	Time Delay before Delay Announcement stops and the trunk is released.	1 sec.	20 sec.	99 sec.
Automatic Disconnect Timer	2D-3	Maximum time before automatic-disconnect of trunk to trunk connections.	10 min.	60 min.	990 min.
DTMF Digit Duration (COI)	4B-1,4B-6, 4B-9	Duration time for each digit dialed on an outside line.	60 mS.	110 mS.	760 mS.
Trunk Hookflash (COI)	4B-1,4B-6	Duration of CO/PBX hookflash when RECALL button is depressed.	300 mS.	1500 mS.	1700 mS.
Hit Protection Time (COI)	4B-2, 4B-7	Minimum duration of a disconnect signal from the central office, before the system disconnects the line.	0	350 mS.	700 mS.
Pause Time (COI)	4B-2, 4B-7	Duration of pauses stored in speed dial memories.	0	1 sec.	7 sec.
Disconnect Recognition Time (COI)	4B-2, 4B-7	The minimum time interval after the system releases a CO line before it can be reaccessed. (This allows time for the CO network to also release the line.)	0	300 mS.	1400 mS.
Interdigital Interval Time (COI)	4B-2,4B-7, 4B-9	Minimum allowable time interval between two consecutively dialed DTMF digits sent by the system to the Central Office.	40 mS.	70 mS.	180 mS.
Hookflash Start Time (SLT)	4B-3, 4B-8	Minimum hookflash duration from a Single Line Telephone in order to receive second dial tone.	100 mS.	300 mS.	800 mS.
Hookflash End Time (SLT)	4B-3, 4B-8	Maximum hookflash duration from a Single Line Telephone in order to receive second dial tone.	HF Start Time	1000 mS.	2200 mS.

**SECTION 350**  
**FUNCTION TIMER CHART (Contd.)**

TIMER	MEMORY BLOCK	DEFINITION	TIMING VALUE		
			Minimum	Default	Maximum
Bounce Protection Time (SLT)	4B-3, 4B-8	Lapsed time after hook flash before detecting on-hook condition.	0	300 mS.	1400 mS.
Disconnect Time (VMI)	4B-9	Duration of timed disconnect signal which is sent to the Voice Mail System	500 mS.	1500 mS.	7 sec.
Answer Detect (TLI)	4E-4	Time duration needed to recognize an answer from the called party.	0	520 mS.	1820 mS.
Release Detect (TLI)	4E-4	Minimum time after hanging up before E lead recognizes a disconnect from the CO.	0	520 mS.	1820 mS.
Pre-Pause Time (TLI)	4E-4	Lapsed time before sending pulsed digits to CO after distant end goes off-hook.	0	3 sec.	12 sec.
Pause Time (TLI)	4E-4	Duration of pauses stored in speed dial memories.	0	1 sec.	7 sec.
Wink/Delay Incoming Detection Time (TLI)	4E-5	Time duration lapsed before recognizing an off-hook condition from the CO with a delay or wink signal.	0	<u>Delay:</u> 120mS. <u>Wink:</u> 520mS.	<u>Delay:</u> 420mS. <u>Wink:</u> 1820mS.
Length of Wink Signal (TLI)	4E-5	Length of wink signal sent to the distant end.	30 mS.	180 mS.	450 mS.
Length of Delay Signal (TLI)	4E-5	Length of delayed signal sent to the distant end.	0	300 mS.	4200 mS.
Loop Off-Guard Time (TLI)	4E-5	Time duration lapsed before recognizing a disconnect condition after sending an answer signal (on loop dial Tie lines).	0	2 sec.	12 sec.
Wink/Delay Signal Detection Timeout (TLI)	4E-6	The length of time, in seconds, that the system will monitor the central office line for receipt of a wink signal.	1 sec.	7 sec.	9 sec.
Outgoing Guard Time (TLI)	4E-6	Time duration lapsed after sending a disconnect signal that the line is monitored to verify a distant disconnect (on loop dial tie Lines).	20 msec.	3 sec.	14 sec.
Tandem Restriction / LCR Control Timer (TLI)	4E-6	When using a Tandem Port, the maximum time before the voice path is established, after dialing the first digit and between each digit dialed.	2 sec.	12 sec.	28 sec. or ∞
DTMF Interdigit Time (TLI)	4E-8	Minimum time duration between DTMF digits when dialing.	40 msec.	70 msec.	180 msec.
DTMF Duration Time (TLI)	4E-8	Duration time of tie line DTMF digits.	60 msec.	1 1 0 msec.	760 msec.

## SECTION 360 CODE / CALL RESTRICTION

### 360.1 General

To provide dialing restrictions on an individual station basis, a method of code restriction has been designed into the Electra MarkII system. The Electra MarkII utilizes a pattern of 32 system tables containing specific area and office codes. Each table is set as an *allow* or *deny* table. Allowing restricted stations to dial only specific area and office codes is then accomplished by assigning one or more tables to the stations as required. If operator restriction (Memory Block 1D7) is not assigned to a station, then it is not restricted from dialing any number. This section will fully explain this procedure. *It is recommended that before attempting to program any code restrictions that this section be fully reviewed.*

Table 360-1

MEMORY BLOCK	CODE TABLE NUMBER				
3E5	ALLOW / DENY				
3E6	TRUNK GROUP	1	2	3	4
3E7	OCC FLAG				
3E8	OCC CODE ASSIGNMENT	1		2	
3E9	C O D E	NO.	AREA CODE	OFFICE CODE	
		1			
		2			
		3			
		4			
		5			
		6			
		7			
8					

There are 32 system code tables (Example shown in Table 360-1) available on the Electra MarkII system. Each table has several parameters assignable.

#### Allow/Deny Parameter

Each table can be assigned as an *allow* or a *deny* table. If a table is set as a *deny* table, stations assigned this table will be restricted from dialing any area code or area + office code entered into the table. If a station is assigned a *deny* table and an *allow* table that both contain identical area or area + office codes, the system will *allow* the station to dial the

number if the *allow* table number comes before the *deny* table number.

Example: Operator restriction is assigned to station 104.

- A. Station 104 is assigned Table 01 and Table 14
- B. Table 01 is assigned as an *allow*
- C. Table 14 is assigned as a *deny*
- D. Table 01 has its first entry programmed for 516 753
- E. Table 14 has its first entry programmed for 516\*\*\* (\* represents digits 1 ~ 0, #, and \*)

After the 516 is dialed, the system will inspect all the tables assigned to this station starting with the first table then to the next in numerical order; the Electra Mark II system will look for a match between the number entered into a table and the number dialed. The example shows that if 516 is dialed there will be an area code match in Table 01 (containing 516-753) and Table 14, (containing 516). The system only sees the match for Table 01 as it scans the tables in numerical order. If the system first saw the match in Table 14, the station user would have been restricted because Table 14 has been set as *deny*. Although there is a match in Table 01, it is not a complete match because the 516 in the table also contains an office code (753).

The system will, therefore, *allow* Station 104 to dial 3 more digits. If 753 has not been dialed, it no longer sees the match in Table 01. The system will, therefore, only see the match in Table 14 (where an office code has not been specified). If 753 had been dialed, the match would still be seen in Table 01. This example shows a way to restrict a station from dialing all but one office code in a particular area code.

#### Trunk Group Parameter

Each table can be assigned a maximum of four trunk groups. When a code restricted station dials out on a particular trunk group, the system will only look at those tables which are assigned to the station and to the trunk group the station is dialing out on. This allows different restrictions to be set on a station on the trunk group that is accessed.

### OCC (Other Common Carrier) Flag Parameter

Each table has an OCC Flag Parameter which can be set or not. When a station user dials a second common carrier, it is necessary to first dial 10-XXX (XXX identifies the carrier service to be used) before the actual telephone number. To allow/deny a toll restricted station to dial beyond 10, the OCC Flag Parameter must be set in at least one table assigned to the station.

### OCC (Other Common Carrier) Code Parameter

If a station is assigned a table with the OCC Flag set, the system will allow the station to dial 10 and receive equal access. To allow the station to choose a particular carrier the table assigned must have the 3 digit OCC identification code entered. This assignment allows only certain OCC codes to be used by restricted stations.

### Code Numbers Parameters

Each of the systems' 32 tables contain eight entries for digit entry. Each item can hold an area code (3 digit) and or office code (3 digits). Area or office codes to be restricted are placed in *deny* tables. Area codes or office codes to be allowed are placed in *allow* tables.

To simplify the understanding of the code restriction on the Electra MarkII system, its' discussion will be divided into the following sub sections:

1. 1 + dialing area (prefix dialing)
2. Direct dialing area (standard dialing)
3. Equal Access (OCC usage)
4. Puerto Rico area type dialing

**Note:** Depending on the area the Electra MarkII system is installed, one of these four sub sections should apply.

### 360.2 A 1 + dialing area (discussion of flow chart) (refer to flow chart Table 360-2)

#### Step 1: First digit dialed

- a. Digit 0: disconnect station
- b. Digit 1: allow second digit (*go to step 3*)
- c. Any digit 2 to 9: If digit is not a rejection code let user dial two more digits (*go to step 2*)

#### Step 2. Check last 3 digits dialed

- a. Lowest possible table assigned to station which contains the three digit number as an office code entry is found.
  1. Table is allow: allow user free dialing

2. Table is deny : disconnect station
- b. No table is found (*Check memory block 3E-4*)
  1. System Allow: allow user free dialing
  2. System Deny : disconnect station

#### Step 3. Second digit dialed

- a. Digit 0: (*See OCC discussion*)
- b. Digit 1: disconnect station
- c. Any digit 2 to 9 (*go to step 4*)

#### Step 4. Third digit dialed

- a. Any digit 2 to 9: disconnect station
- b. Digit 0 or 1 (*go to step 5*)

#### Step 5. Fourth digit dialed

- a. Lowest possible table assigned to Station which contains the last three digits dialed, as an area code item, is found.
  1. Table is allow:
    - A. Matched item in table also contains an office code (*go to step 6*)
    - B. Matched item in table has only area code : Allow user free dialing
  2. Table is deny
    - A. Matched item in table also contains an office code (*go to step 6*)
    - B. Matched item in table has only area code: disconnect station
  3. No Table is found
    - A. System Allow: Allow user free dialing
    - B. System Deny : disconnect station

#### Step 6. Allow three more digits to be dialed:

- a. If item in table matches area and office code dialed:
  1. Table is allow: allow user free dialing
  2. Table is deny : disconnect station
- b. If item in table no longer matches for area code and office code dialed, locate next lowest table which contains a three digit entry which matches the area code dialed or a 6 digit entry which matches the area and office code dialed.
  1. New table found:
    - a. Table is allow: allow user free dialing
    - b. Table is deny : disconnect station
  2. No Table is found (*check Memory Block 3E-4*)
    - a. System allow: allow user free dialing
    - b. System deny : disconnect station

**360.3 Direct dial area (refer to Table 360-3)**

**Step 1. First digit dialed**

- a. Digit 0: disconnect station
- b. Digit 1: (*go to step 3*)
- c. Any digit 2 to 9, if digit is not a rejection code allow user to dial second digit (*next step*)

**Step 2. Second digit dialed**

- a. Digit 1 or 0: allow next digit to be dialed (*go to step 7*)
- b. Any digit 2 to 9: allow next digit to be dialed (*go to step 6*)

**Step 3. Second digit dialed**

- a. Digit 0: (*See OCC discussion*)
- b. Digit 1: disconnect station
- c. Any digit 2 to 9: (*next step*)

**Step 4. Check memory block 3E1 (area assignment)**

- a. System not assigned ITC: disconnect station
- b. System assigned ITC: allow 3rd digit (*next step*)

**Step 5. Third digit dialed**

- a. Digit 1 or 0: allow next digit (*go to step 7*)
- b. Any digit 2 to 9 allow next digit to be dialed (*next step*)

**Step 6. Check last 3 digits dialed**

- a. Lowest possible table assigned to station which contains the three digit number as an office code is found.
  1. Table is allow: allow user free dialing
  2. Table is deny: disconnect station
- b. No table is found. *Check Memory Block 3E-4*
  1. System allow: allow user free dialing
  2. System deny: disconnect station

**Step 7. Check last 3 digits dialed:**

- a. Lowest possible table assigned to station which contains the last three digits dialed as an area code item is found
  1. Table is allow:
    - A. Matched item in Table also contains an office code (*go to step 8*)
    - B. Matched item in table has only area code; allow user free dialing
  2. Table is deny:
    - A. Matched item in table also contains an office code (*go to step 8*)
    - B. Matched item in table has only area code; Disconnect station

- b. No table found; *check Memory Block 3E-4*
  1. System allow: allow user free dialing
  2. System deny: disconnect station

**Step 8. Allow three more digits to be dialed**

- a. Item in table matches area and office code dialed
  1. Table is allow: allow user free dialing
  2. Table is deny: disconnect station
- b. If item in table no longer matches area and office code dialed, locate next lowest table which contains a three digit entry which matches the area code dialed or a six digit entry which matches the area and office code dialed.
  1. New table found
    - A. Table is allow: allow user free dialing
    - B. Table is deny: disconnect station
  2. No table is found; *Check Memory Block 3E-4*
    - A. System allow: free dialing
    - B. System deny: disconnect station

**360.4 OCC (other common carrier access) (refer to Table 360-4)**

**Step 1. First two digits dialed are 10:**

- a. If one or more tables assigned have OCC Flag set, then allow 3 more digits to be dialed (*next step*)
- b. If no table assigned has OCC Flag set, then disconnect station

**Step 2. Check last three digits dialed:**

- a. All three digits are dialed within ten seconds: Allow next digit to be dialed (*next step*)
- b. All three digits not dialed within 10 seconds: Disconnect station

**Step 3. Sixth digit dialed:**

- a. Digit 0: disconnect station
- b. Digit 1: allow 3 more digits (*go to step 6*)
- c. Any digit 2 to 9: allow one more digit (*next step*)

**Step 4. Seventh digit dialed:**

- a. Digit 1 or 0: allow one more digit (*go to step 6*)
- b. Any digit 2 to 9: allow one more digit (*next step*)

**Step 5. Check last 6 digits dialed:**

- a. Lowest possible table assigned to the station which contains the third, fourth, and fifth

digits as an OCC code and the sixth, seventh, and eighth digits as an office code is found:

1. Table is allow: allow user free dialing
  2. Table is deny: disconnect station
- b. Table is not found. *Check Memory Block 3E-4*
1. System allow: allow user free dialing
  2. System deny: disconnect station

Step 6. Check third, fourth, and fifth digits and the last three digits dialed

- a. Lowest possible table assigned to station which contains third, fourth, and fifth digit as an OCC code item and the last three digits dialed as an area code entry is found:

1. Table is allow
  - A. Matched area code item in table also contains an office code: (*go to step 7*)
  - B. Matched area code item in table does not include an office code: allow user free dialing
2. Table is deny
  - A. Matched area code item in table also contains an office code: (*go to step 7*)
  - B. Matched area code item in table does not include an office code: disconnect station

- b. No table found. *Check Memory Block 3E-4*
1. System allow: allow user free dialing
  2. System deny: disconnect station

Step 7. Allow three more digits to be dialed

- a. Six digit item in table matches last six digits dialed
1. Table is allow: allow user free dialing
  2. Table is deny: disconnect station
- b. If item in table no longer matches the last six digits dialed, locate next lowest table assigned to the station which contains an OCC code which matches the third, fourth, and fifth digits dialed and either a three digit entry which matches the area code dialed or a six digit entry that matches the last 6 digits dialed (area + office code)
1. New table found:
    - A. Table is allow: allow user free dialing
    - B. Table is deny: disconnect station
  2. No table is found: *check Memory Block 3E-4*
    - A. System allow: allow user free dialing
    - B. System deny: disconnect station

### 360.5 Puerto Rico (refer to Table 360-5)

Step 1. First digit dialed

- a. Digit 0: disconnect station
- b. Any digit 1 to 9: allow two more digits to be dialed

Step 2. Check last three digits dialed

- a. An item in the special code table matches last three digits dialed: to allow another digit (*next step*)

NOTE: When Memory Block 3E-1 is assigned as Puerto Rico, Code Table 32 is used as a special code table only.

- b. No item in the special code table matches last three digits dialed

Step 3. 4th Digit Dialed

- a. Digit 1 or 0: disconnect station
- b. Any digit 2 to 9: allow user to dial another digit (*next step*)

Step 4. 5th Digit Dialed

- a. Digit 1 or 0: allow another digit (*go to step 6*)
- b. Any digit 2 to 9: allow another digit (*next step*)

Step 5. Check last 3 digits dialed

- a. Lowest possible table assigned to station which contains the last three digits dialed as an office code entry is found
  1. Table is allow: allow user free dialing
  2. Table is deny: disconnect station
- b. No table is found: *check Memory Block 3E-4*
  1. System is allow: allow user free dialing
  2. System is deny: disconnect station

Step 6. Check last 3 digits dialed

- a. Lowest possible table assigned to station which contains the last three digits dialed as an area code entry.
  1. Table is allow
    - A. Matched item in table also contains an office code (*go to step 7*)
    - B. Matched item in table has only area code: allow user free dialing
  2. Table is deny
    - A. Matched item in table also contains an office code (*go to step 7*)



- B. Matched item in table has only area code: *disconnect station*
  - b. No table is found: *check Memory Block 3E-4*
    - 1. System allow: allow user free dialing
    - 2. System deny : disconnect station
- Step 7. Allow three more digits to be dialed
- a. Item in table matches last 6 digits dialed
    - 1. Table is allow: allow user free dialing
    - 2. Table is deny : disconnect station
  - b. If item in table no longer matches the last six

digits dialed, locate next lowest table which contains a three digit entry which matches the area code dialed or a six digit entry which matches the area and office code (last 6 digits) dialed.

- 1. New table found
  - A. Table is allow: allow user free dialing
  - B. Table is deny : disconnect station
- 2. No table found: *check Memory Block 3E-4*
  - A. System allow: allow user free dialing
  - B. System deny : disconnect station

TABLE 360-2 1 + DIAL AREA

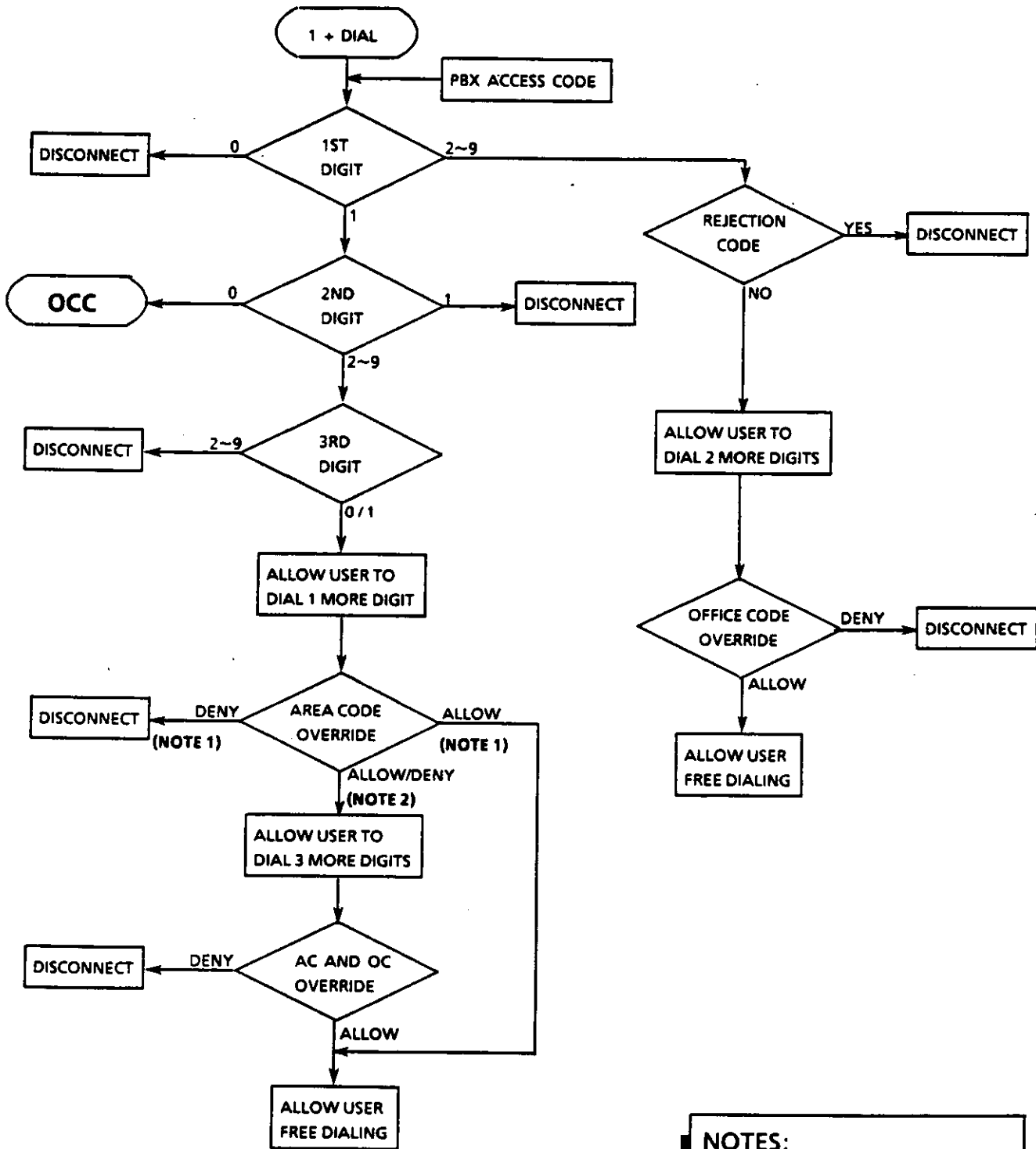

**NOTES:**  
 1. No office code included with area code entry.  
 2. Office code included with area code entry.

TABLE 360-3 DIRECT DIAL AREA

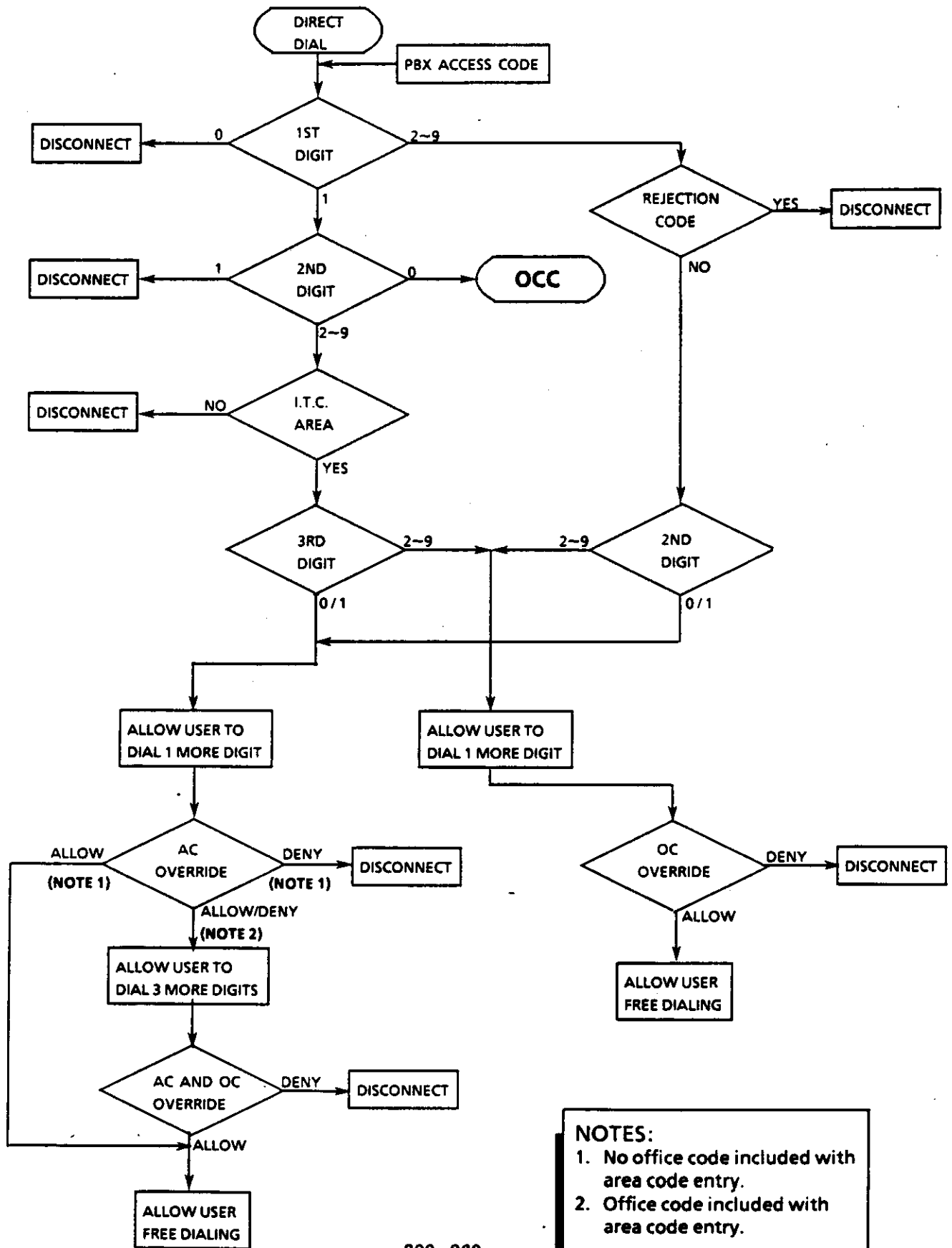

**NOTES:**  
 1. No office code included with area code entry.  
 2. Office code included with area code entry.

TABLE 360-4 OTHER COMMON CARRIER ACCESS

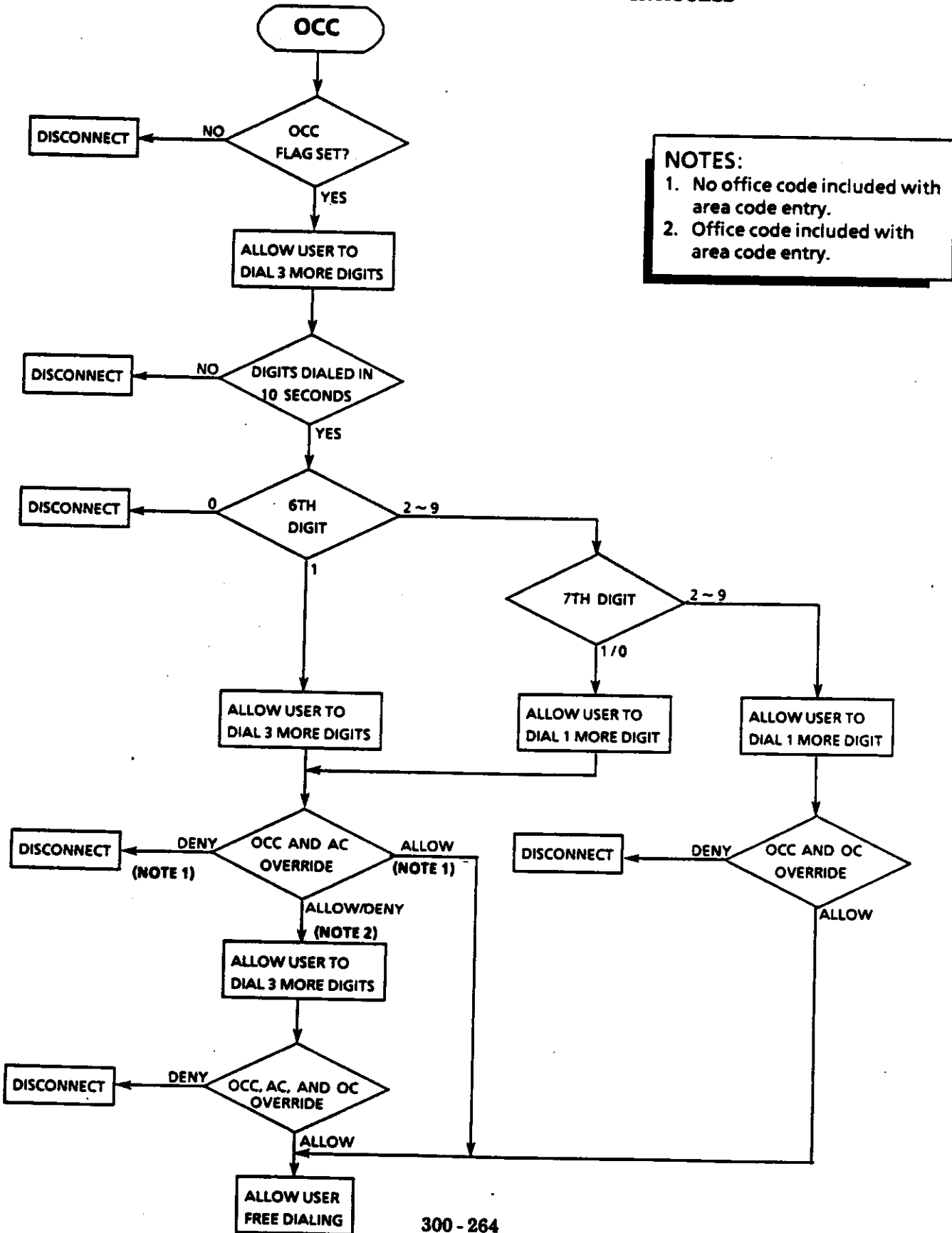

**NOTES:**  
 1. No office code included with area code entry.  
 2. Office code included with area code entry.

TABLE 360-5 SPECIAL CODE OVERRIDE TABLE

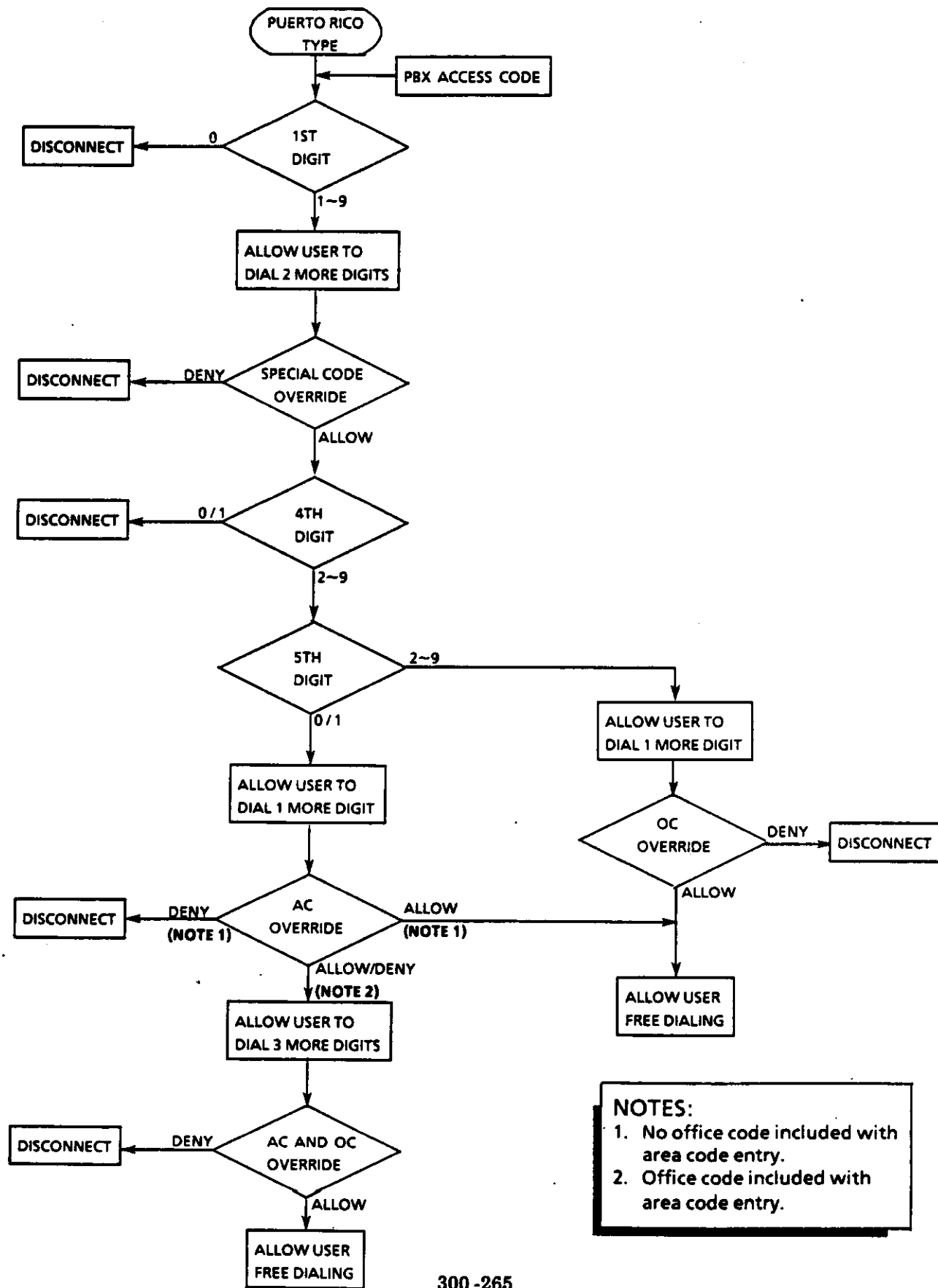

**NOTES:**  
 1. No office code included with area code entry.  
 2. Office code included with area code entry.

# SECTION 370 JOB SPECIFICATION SHEETS TABLE OF CONTENTS

MEMORY ASSIGNMENT BLOCK	MEMORY ASSIGNMENT	PAGE	MEMORY ASSIGNMENT BLOCK	MEMORY ASSIGNMENT	PAGE	MEMORY ASSIGNMENT BLOCK	MEMORY ASSIGNMENT	PAGE
1A -	Line Key Assignment	270	1D -	Station Feature Prime / Ringing Line Assignment	278	5	CO # and * as 1st. Digit	
1	CO Line		1	User Program		6	SMDR Print (Incoming)	
3	Pooled Line		3	Trunk Group Incoming Restriction		7	Internal All Call	
4	Extension		4	Trunk Group Outgoing Restriction		8	Account Code Digit	
6	Data Transmit		5	Code Restriction Table Access		9	PBX Outgoing Code	
7	Data Receive		6	Class of Service Terminal to Attendant Assignment		10	Tie Line Digit Restriction	286
8	Save & Repeat		7	Terminal to Paging Zone Assignment				
10	DND Position		8	Call Pickup Group Assignment				
			9	Data Services Assignment	280			
1B -	Ring Assignment	270	1E -	Station Assignment	278	2B -	System Feature 2	284
10	Day / Night Mode		1	Terminal Exchange		1	Modem Pooling/Terminal	
			2	Terminal Add Port		2	Keyboard Dialing	
1C -	DSS Button Assignment	272		Speed Dial Tenant Assignment	282	5	Allow Forward Override	
1	DSS / BLF to Attendant		3	Speed Dial Override		6	LCR 1 + Dialing Assignment	
3	Feature and Station Appearance		1	Programming Telephone	284	9	LCR Local Call Override Assignment	
4	Flexible Function Key Assignment		4	Incoming Prime Line Pickup		10	LCR Bypass	
							Recall Key Operation for Tie Lines	320
2	BLF Feature to Telephone Assignment	274					DIT Trunk to Tenant	
						3	Assignment	288
5	DSS to CO Add-On Module Assignment	276					DIT/ANA Assignment	
6	CO Add-On Module Line Key Assignment					4	Modem Pool Assignment	
7	CO Add-On Module Day Ring Assignment					7	SLT to VMI Assignment	
8	CO Add-On Module Night Ring Assignment					8	System Group Trunk to Trunk Group Assignment	284
							Trunk Group to Tenant Assignment	
							Trunk Group to Trunk Access Code Assignment	

## JOB SPECIFICATION SHEETS TABLE OF CONTENTS

MEMORY ASSIGNMENT BLOCK	PAGE	MEMORY ASSIGNMENT BLOCK	PAGE	MEMORY ASSIGNMENT BLOCK	PAGE
4	VMI Hunting Group	9	Trunk Group to Line Pool Group Assignment	8	Table - OCC Code Assignment
5	Delay Announce	1	First Ring Pattern Assignment	9	Restriction Table Code Assignment
6	Uniform Dial to Trunk Access Code Group	2	Centrex Ringing Assignment	4B	Card Mode
7	Night Chime Assignment	5	Station to Hunt Group Pilot Number Assignment	1	COI-I Initialized Values (Trunk Programming Parameters)
8	External Ringing Control	6	Station to Hunt Group Assignment	2	COI-II Initialized Values (Trunk Programming Parameters)
9	ECR Relay Assignment	7	Station Hunt Type Assignment	3	SLI Common Values
10	Virtual Extension Assignment	8	Station Hunt Group Assignment	4	ESI-EB Data and Second Voice Path Assignment
		10	Line Pool Group Auto Extension Assignment	6	COI-III Initialized Values (Trunk Group Programming Parameters)
2D				7	COI-IV Initialized Values (Trunk Group Programming Parameters)
1	System Time Base			8	VMI Initialize 1
2	Time Base Assign I			9	VMI Initialize 2
3	Time Base Assign II			4C	Card Interface
				1	Card Interface Slot Assignment
2E	System Access Code	3C	System Name Assignment	4E-1	TLI Programming
		1	Telephone Name Assignment	1	TLI Line Type Assignment
3A	System Attendant Assignment	2	Trunk Group Name Assignment		
2	Attendant 3rd. and 4th. Assignment				
3	Attendant (Overflow) Call Shift				
4	Attendant to Tenant Assignment				
		3E	System Restriction Table		
3B	System Hunt Assignment	1	Regional Dialing Type		
3	Forced Account Code Digit Assignment	2	1 + Dialing Assignment		
4	RAA SLT Assignment	3	Rejection Code Assignment		
		4	System Allow / Deny		
		10	Special Code Assignment		
		5	Table Allow / Deny		
		6	Trunk Group to Code Table		
		7	Table - OCC Flag Assignment		
				304	
				306	
				300	
				270	
				302	
				308	
				310	
				312	
				314	

# JOB SPECIFICATION SHEETS TABLE OF CONTENTS

MEMORY BLOCK	ASSIGNMENT	PAGE
2	TLI Dial Tone Assignment	
3	TLI Digit Add/ Delete Assignment	
4	TLI-I Initialized Values	316
5	TLI-II Initialized Values	
6	TLI-III Initialized Values	
7	TLI-IV Initialized Values	318
8	TLI-V Initialized Values	
9	Tandem Port to Hunt Group Assignment	320
10	Trunk Group to Tandem Hunt Group Assignment	



## JOB SPECIFICATION SHEETS

This section consists of sample Job Specification Sheets that when filled out contain all the system programming values and configuration information.

During the initial stages of system planning, the job specification sheets are necessary for collecting information to accurately configure the installation of the Electra MarkII system. The customer information, as collected by the salesperson (or installation supervisor) is recorded onto the specification sheets. Samples of these sheets are arranged in logical order of the memory blocks to make the system programming as efficient as possible. The first group of sheets are used for entering station features. Line button assignments for Multiline Terminals and DSS/BLFs as well as dialing restrictions and class of service (as required by the customer) are listed here. The second group of sheets are used for assigning system features. Assignment of trunk groups, specialized

services, and assignment of system attendants are entered in this group. The last group is used for documenting all the necessary information about the hardware configuration. This group is very useful to service technicians who need to keep track of adds, moves, and changes. In some cases this group is used during troubleshooting.

The first page of each job sheet includes a brief description of each column and possible entries. After initial installation, job sheets must be kept up to date and left on site to provide technicians with the necessary information required when servicing the system; a duplicate copy should also be kept in the servicing office customer's file.

Each CPU-E( ) ETU is shipped with a copy of the complete job specification sheet manual (ND-20234). Additional copies can be obtained by ordering Stock Number 700402.

# JOB SPECIFICATION INSTRUCTIONS FOR

## MEMORY BLOCKS 1A, 1B & 3B-10 LINE KEY, RINGING AND LINE POOL GROUP AUTO EXTENSION ASSIGNMENT

### ITEM

STATION #	RUN #	STA. TYPE
NAME / LOCATION		

STATION #	RUN #	STA. TYPE
NAME / LOCATION		

STATION #	RUN #	STA. TYPE
NAME / LOCATION		

STATION #	RUN #	STA. TYPE
NAME / LOCATION		

L1	
----	--

L1	
----	--

### DESCRIPTION

EXTENSION BEING ASSIGNED  
(STATION NUMBER)

EXTENSION (100 ~ 899)  
or  
(1000 ~ 8999)

### ENTRY

ASSOCIATED STATION CABLE  
RUN NUMBER

TYPE OF TERMINAL  
(STATION TYPE)

ETE-6(-) (6), ETE-16K-1 (16K)  
ETE-6D(-) (6D), RAA-E UNIT (RAA)  
ETE-16-2 (16)  
ETE-16D(-) (16D)

NAME AND/OR LOCATION OF  
STATION USER

LINE KEY APPEARANCE

TRUNK/CO LINE (T01 ~ T40), POOL (P1 ~ P8)  
EXTENSION (100 ~ 899) or (1000 ~ 8999)  
SAVE & REPEAT (S01 ~ S80), DO NOT DISTURB (DND)  
DATA TRANSMIT (DT), DATA RECEIVE (DR)

RINGING ASSIGNMENT

DAY RING (D), NIGHT RING (N)  
BOTH RING (B), LEAVE BLANK FOR NO RING  
DAY DELAYED (DL), NIGHT DELAYED (NL)  
BOTH DELAYED (BL), DAY RING & NIGHT DELAYED (RL)  
DAY DELAYED & NIGHT RING (LR)

LINE POOL GROUP AUTO  
EXTENSION ASSIGNMENT

L1		ASSIGNED
L1		NOT ASSIGNED

# MEMORY BLOCKS 1A, 1B & 3B-10 LINE KEY, RINGING AND POOL AUTO EXTENSION ASSIGNMENTS

STATION #	RUN #	STA. TYPE	L1	L2	L3	L4	L5	L6	L7	L8
NAME / LOCATION			L9	L10	L11	L12	L13	L14	L15	L16

STATION #	RUN #	STA. TYPE	L1	L2	L3	L4	L5	L6	L7	L8
NAME / LOCATION			L9	L10	L11	L12	L13	L14	L15	L16

STATION #	RUN #	STA. TYPE	L1	L2	L3	L4	L5	L6	L7	L8
NAME / LOCATION			L9	L10	L11	L12	L13	L14	L15	L16

STATION #	RUN #	STA. TYPE	L1	L2	L3	L4	L5	L6	L7	L8
NAME / LOCATION			L9	L10	L11	L12	L13	L14	L15	L16

STATION #	RUN #	STA. TYPE	L1	L2	L3	L4	L5	L6	L7	L8
NAME / LOCATION			L9	L10	L11	L12	L13	L14	L15	L16

STATION #	RUN #	STA. TYPE	L1	L2	L3	L4	L5	L6	L7	L8
NAME / LOCATION			L9	L10	L11	L12	L13	L14	L15	L16

STATION #	RUN #	STA. TYPE	L1	L2	L3	L4	L5	L6	L7	L8
NAME / LOCATION			L9	L10	L11	L12	L13	L14	L15	L16

STATION #	RUN #	STA. TYPE	L1	L2	L3	L4	L5	L6	L7	L8
NAME / LOCATION			L9	L10	L11	L12	L13	L14	L15	L16

# JOB SPECIFICATION INSTRUCTIONS FOR MEMORY BLOCKS 1C-1, -3, & -4 DSS BUTTON ASSIGNMENTS FOR EDE-30-1 ITEM

ASSOCIATED ATTENDANT STATION	
ROW	COLUMN
1	1.1 1.2 1.3 1.4 1.5
2	
3	
4	
5	
6	
FLEXIBLE FUNCTION	

ASSOCIATED ATTENDANT  
BEING ASSIGNED

ASSOCIATED ATTENDANT  
EXTENSION NUMBER

ENTRY

ASSOCIATED ATTENDANT STATION	
ROW	COLUMN
1	1.1 1.2 1.3 1.4 1.5
2	
3	
4	
5	
6	
FLEXIBLE FUNCTION	

ASSIGNMENT OF DSS BUTTONS  
(EXTENSION NUMBERS AND/OR FEATURES)

ASSOCIATED ATTENDANT STATION	
ROW	COLUMN
1	1.1 1.2 1.3 1.4 1.5
2	
3	
4	
5	
6	
FLEXIBLE FUNCTION	

ASSIGNMENT OF FUNCTION  
BUTTONS  
(FEATURES ONLY)

- EXTENSION (100~899) or (1000~8999)
- VIRTUAL EXTENSION (200~247)
- VMI EXTENSION (100~899 or 1000~8999)
- HUNT PILOT NUMBER (100~899 or 1000~8999)
- MW = MESSAGE WAIT
- XFR = TRANSFER
- OVRD = ATTENDANT OVERRIDE
- NT = NIGHT TRANSFER
- PZ (#) = PAGE ZONE (5~13)
  - 05 = Internal All Call
  - 06 = Internal Zone 1
  - 07 = Internal Zone 2
  - 08 = Internal Zone 3
  - 09 = Internal All Zones
  - 10 = External Zone 1
  - 11 = External Zone 2
  - 12 = External Zone 3
  - 13 = External All Zones

# MEMORY BLOCKS 1C-1, -3, & -4 DSS BUTTON ASSIGNMENTS FOR EDE-30-1

DSS/BLF #1		ASSOCIATED ATTENDANT STATION				
ROW	COLUMN					FLEXIBLE FUNCTION
	L1	L2	L3	L4	L5	
1						
2						
3						
4						
5						
6						

DSS/BLF #3		ASSOCIATED ATTENDANT STATION				
ROW	COLUMN					FLEXIBLE FUNCTION
	L1	L2	L3	L4	L5	
1						
2						
3						
4						
5						
6						

DSS/BLF #5		ASSOCIATED ATTENDANT STATION				
ROW	COLUMN					FLEXIBLE FUNCTION
	L1	L2	L3	L4	L5	
1						
2						
3						
4						
5						
6						

DSS/BLF #2		ASSOCIATED ATTENDANT STATION				
ROW	COLUMN					FLEXIBLE FUNCTION
	L1	L2	L3	L4	L5	
1						
2						
3						
4						
5						
6						

DSS/BLF #4		ASSOCIATED ATTENDANT STATION				
ROW	COLUMN					FLEXIBLE FUNCTION
	L1	L2	L3	L4	L5	
1						
2						
3						
4						
5						
6						

DSS/BLF #6		ASSOCIATED ATTENDANT STATION				
ROW	COLUMN					FLEXIBLE FUNCTION
	L1	L2	L3	L4	L5	
1						
2						
3						
4						
5						
6						

# JOB SPECIFICATION INSTRUCTIONS FOR MEMORY BLOCK 1C-2 BLF FEATURE TO TELEPHONE ASSIGNMENT

ITEM		DESCRIPTION	ENTRY
MODULE NUMBER			
BLF ASSIGNMENT NUMBER	STATION NUMBER		
1		MODULE NUMBER	1~4
2		EXTENSION NUMBER OF EACH ETE-16D-( ) MULTILINE TERMINAL WITH BLF FEATURE.	EXTENSION (100~899) or (1000~8999)
3			
4			
5			
6			
7			
8			
9			
10			

**NOTE:** 30 terminals may have the BLF feature assigned. Only 10 per CCU.

# MEMORY BLOCK 1C-2 BLF FEATURE TO TELEPHONE ASSIGNMENT

MODULE NUMBER	
BLF ASSIGNMENT NUMBER	STATION NUMBER
1	
2	
3	
4	
5	
6	
7	
8	
9	
10	

MODULE NUMBER	
BLF ASSIGNMENT NUMBER	STATION NUMBER
11	
12	
13	
14	
15	
16	
17	
18	
19	
20	

MODULE NUMBER	
BLF ASSIGNMENT NUMBER	STATION NUMBER
21	
22	
23	
24	
25	
26	
27	
28	
29	
30	

**NOTE: ONLY ETE-16D-( ) MULTILINE TERMINALS CAN BE ASSIGNED THIS FEATURE.  
30 TERMINALS MAXIMUM, 10 PER CCU.**

# JOB SPECIFICATION INSTRUCTIONS FOR MEMORY BLOCKS 1C-5, -6, -7 & -8

## ITEM

ASSOCIATED ATTENDANT STATION	
EDE-30-1 DEVICE NUMBER	
COLUMN	ENTRY
L1	XXXX
L2	XXXX
L3	XXXX
L4	XXXX
L5	XXXX

ASSOCIATED ATTENDANT  
BEING ASSIGNED

EXTENSION NUMBER  
(XXXX OR XXXX)

ASSOCIATED ATTENDANT STATION	
EDE-30-1 DEVICE NUMBER	
COLUMN	ENTRY
L1	XXXX
L2	XXXX
L3	XXXX
L4	XXXX
L5	XXXX

ASSIGNMENT OF EDE-30-1  
UNIT AS A CO ADD-ON MODULE

EDE-30-1 UNIT DEVICE NUMBER (1~6)

ASSOCIATED ATTENDANT STATION	
EDE-30-1 DEVICE NUMBER	
COLUMN	ENTRY
L1	XXXX
L2	XXXX
L3	XXXX
L4	XXXX
L5	XXXX

ASSIGNMENT OF LINE KEYS

CO TRUNKS (01~40)

ASSOCIATED ATTENDANT STATION	
EDE-30-1 DEVICE NUMBER	
COLUMN	ENTRY
L1	XXXX
L2	XXXX
L3	XXXX
L4	XXXX
L5	XXXX

RINGING ASSIGNMENT

ENTER:

- DAY RING (D)
- NIGHT RING (N)
- BOTH RING (B)
- LEAVE BLANK FOR NO RING
- DAY DELAYED (DL)
- NIGHT DELAYED (NL)
- BOTH DELAYED (BL)
- DAY RING & NIGHT DELAYED (RL)
- DAY DELAYED & NIGHT RING (LR)



# MEMORY BLOCKS 1C-5,-6,-7 & -8 CO ADD-ON MODULE ASSIGNMENTS FOR EDE-30-1

CO ADD-ON MODULE #1		ASSOCIATED ATTENDANT STATION				
EDE-30-1 DEVICE NUMBER						
ROW	COLUMN					
	L1	L2	L3	L4	L5	
1						
2						
3						
4						
5						
6						

CO ADD-ON MODULE #3		ASSOCIATED ATTENDANT STATION				
EDE-30-1 DEVICE NUMBER						
ROW	COLUMN					
	L1	L2	L3	L4	L5	
1						
2						
3						
4						
5						
6						

CO ADD-ON MODULE #2		ASSOCIATED ATTENDANT STATION				
EDE-30-1 DEVICE NUMBER						
ROW	COLUMN					
	L1	L2	L3	L4	L5	
1						
2						
3						
4						
5						
6						

CO ADD-ON MODULE #4		ASSOCIATED ATTENDANT STATION				
EDE-30-1 DEVICE NUMBER						
ROW	COLUMN					
	L1	L2	L3	L4	L5	
1						
2						
3						
4						
5						
6						

# JOB SPECIFICATION INSTRUCTIONS FOR MEMORY BLOCKS

## 1D-1, -3, -4, -5, -6, -7, -8, -9, -10, AND 1E-1 & -2 STATION ASSIGNMENTS

STATION #	PRIME/RINGING LINE KEY	SLT RINGING LINE	OFF VOICING LINE	RINGING LINE	USER PROGRAM	TRUNK RESTRICTIONS	CODE TABLE ACCESS	CLASS OF SERVICE	STATION ADD PORT
1	1-40 (L1-L16)	L1	L2	L3	L4	L5	L6	L7	L8
2									
3									
4									
5									
6									
7									
8									
9									
10									
11									
12									
13									
14									
15									
16									
17									
18									
19									
20									
21									
22									
23									
24									
25									
26									
27									

ITEM	DESCRIPTION	ENTRY
1	STATION NUMBER TO BE ASSIGNED	EXTENSION (100~399 or 1000~1299)
2	LINE KEY TO BE ASSIGNED THE PRIME LINE FEATURE	(VIRTUAL EXTENSION 200~247)
3	IDLE LINE SEIZED WHEN GOING OFF HOOK	1 ~ 16
4	LINE SEIZED DURING RING WHEN GOING OFF HOOK	✓ (IF CHOSEN), OR, ✓ (IF CHOSEN), OR, ✓ (IF PRIME/RINGING LINE FEATURES ARE CHOSEN)
5	SELECTION OF BOTH PRIME LINE AND RINGING LINE FEATURES	1 ~ 40
6	CO LINE TO BE ASSIGNED AS PRIME LINE FOR AN SLT.	✓ TO ALLOW
7	INCOMING RINGING WHILE OFF HOOK.	V = VOICE OR T = TONE
8	SELECTION OF VOICE OR TONE INCOMING SIGNALING	1 = TONE #1 2 = TONE #2
9	SELECTION OF A RINGING TONE	1 = INCOMING RESTRICTED 0 = OUTGOING RESTRICTED B = IN/OUT RESTRICTED BLANK = UNRESTRICTED
10	RESTRICTIONS APPLIED TO THE 8 TRUNK GROUPS	ANY COMBINATION OF TABLES 1~32
11	TABLES PREVIOUSLY ASSIGNED FOR CODE RESTRICTION	✓ TO ALLOW
12	ABILITY TO CAMP ONTO A BUSY EXTENSION	✓ TO ALLOW
13	ABILITY TO RECEIVE A CAMP WHILE BUSY	✓ TO ALLOW
14	ABILITY TO CALL FORWARD STATION CALLS	✓ TO ALLOW
15	OPERATOR RESTRICTION ON CO LINES	✓ TO RESTRICT
16	DENIES ALL INCOMING TONES TO PROTECT DATA TRANSMISSION	✓ TO ALLOW
17	PLACES STATION OUT OF SERVICE BY USING A SPECIAL CODE	✓ TO ALLOW
18	ACCESS TO PAGING CODES	✓ TO ALLOW
19	PROVIDES LEAST COST ROUTING ON EXTENSION CALLS TO OUTSIDE	✓ TO ALLOW
20	CAPABILITY TO TRANSFER TRUNK TO TRUNK WITHOUT USING A CNF-E TU	✓ TO ALLOW
21	ACCOUNT CODE FORCED/VERIFIED	✓ TO ALLOW
22	SELECTION OF ASSOCIATED ATTENDANT (DIAL 0)	1, 2, 3, or 4
23	ASSIGNMENT OF STATION INTO INTERNAL PAGING ZONE	NONE, 1, 2, or 3
24	ASSIGNMENT OF STATION INTO CALL PICKUP GROUP	NONE, 1, 2, 3, 4, 5, 6, 7, or 8
25	EXCHANGE OF ASSIGNED EXTENSION NUMBERS	EXTENSION (100~899 or 1000~8999)
26	STATION TYPE ASSIGNMENT	✓ APPROPRIATE COLUMN
27	SLT ASSIGNMENT	✓ IF APPROPRIATE



# JOB SPECIFICATION INSTRUCTIONS FOR MEMORY BLOCK 1D-2 DATA SERVICE ASSIGNMENT

**ITEM**

STATION #	ENABLE AUTOMATIC ANSWER FOR DATA CALLS (L1)	ENABLE AUTOMATIC RELEASE FOR DATA CALLS (L2)	DTR SIGNAL VALID (L3)	ALLOW INCOMING INTERNAL DATA CALL DURING CO CONVERSATION (L4)	DURING CO CONVERSATION, DR KEY DEPRESSION TO REJECT INCOMING INTERNAL DATA CALL AND ACTIVATE MODEM POOL (L5)	RECEIVE LCD INDICATION FOR DATA CALLS (L6)
1	2	3	4	5	6	7

**DESCRIPTION**

**ENTRY**

- ① STATION WITH DATA SERVICE.
  - ✓ EXTENSION NUMBER (100 ~ 899 or 1000 ~ 8999)
- ② AUTOMATIC ANSWER FOR DATA CALLS.
  - ✓ IF ASSIGNED; LEAVE BLANK IF NOT ASSIGNED.
- ③ AUTOMATIC RELEASE FOR DATA CALLS.
  - ✓ IF ASSIGNED; LEAVE BLANK IF NOT ASSIGNED.
- ④ DTR SIGNAL VALIDITY.
  - ✓ IF DTR SIGNAL IS TO BE CONSIDERED VALID; LEAVE BLANK IF IT WILL BE CONSIDERED INVALID.
- ⑤ INCOMING INTERNAL DATA CALLS DURING CO CONVERSATION.
  - ✓ IF ALLOW; LEAVE BLANK IF PROHIBITED.
- ⑥ DEPRESSION OF DR KEY DURING CO CONVERSATION, WHILE RECEIVING AN INCOMING INTERNAL DATA CALL.
  - ✓ IF INCOMING CALL IS TO BE REJECTED AND THE MODEM POOL ACTIVATED; LEAVE BLANK IF THE INCOMING INTERNAL DATA CALL IS TO BE ACCEPTED.
- ⑦ LCD INDICATION FOR DATA CALLS.
  - ✓ IF PROVIDED; LEAVE BLANK IF NOT PROVIDED.



# JOB SPECIFICATION INSTRUCTIONS FOR MEMORY BLOCKS 2A-2 & -3 SPEED DIAL TENANT AND OVERRIDE ASSIGNMENTS

ITEM	DESCRIPTION	ENTRY																				
<table border="1" style="width: 100%; border-collapse: collapse;"> <thead> <tr> <th style="width: 15%;">BUFFER #</th> <th style="width: 60%;">NUMBER STORED (16 CHARACTERS MAXIMUM)</th> <th style="width: 15%;">TENANT #1</th> <th style="width: 10%;">TENANT #2</th> <th style="width: 10%;">TENANT #3</th> </tr> </thead> <tbody> <tr> <td style="text-align: center;">20</td> <td></td> <td style="text-align: center;">O V E R R I D E</td> <td style="text-align: center;">O V E R R I D E</td> <td style="text-align: center;">O V E R R I D E</td> </tr> <tr> <td style="text-align: center;">21</td> <td></td> <td style="text-align: center;">A S S I G N E D</td> <td style="text-align: center;">A S S I G N E D</td> <td style="text-align: center;">A S S I G N E D</td> </tr> <tr> <td style="text-align: center;">22</td> <td></td> <td></td> <td></td> <td></td> </tr> </tbody> </table>	BUFFER #	NUMBER STORED (16 CHARACTERS MAXIMUM)	TENANT #1	TENANT #2	TENANT #3	20		O V E R R I D E	O V E R R I D E	O V E R R I D E	21		A S S I G N E D	A S S I G N E D	A S S I G N E D	22					<p>BUFFERS ARE ASSIGNED TO TENANTS 1 - 3. A MAXIMUM OF 16 CHARACTERS MAY BE ASSIGNED TO EACH BUFFER.</p>	<p>UP TO 16 DIGITS / CHARACTERS, #, *, 1~9, PAUSE CHECK BOX IN TENANT(S) COLUMN(S) ASSIGNED.</p>
BUFFER #	NUMBER STORED (16 CHARACTERS MAXIMUM)	TENANT #1	TENANT #2	TENANT #3																		
20		O V E R R I D E	O V E R R I D E	O V E R R I D E																		
21		A S S I G N E D	A S S I G N E D	A S S I G N E D																		
22																						

<table border="1" style="width: 100%; border-collapse: collapse;"> <thead> <tr> <th style="width: 15%;">BUFFER #</th> <th style="width: 60%;">NUMBER STORED (16 CHARACTERS MAXIMUM)</th> <th style="width: 15%;">TENANT #1</th> <th style="width: 10%;">TENANT #2</th> <th style="width: 10%;">TENANT #3</th> </tr> </thead> <tbody> <tr> <td style="text-align: center;">20</td> <td></td> <td style="text-align: center;">O V E R R I D E</td> <td style="text-align: center;">O V E R R I D E</td> <td style="text-align: center;">O V E R R I D E</td> </tr> <tr> <td style="text-align: center;">21</td> <td></td> <td style="text-align: center;">A S S I G N E D</td> <td style="text-align: center;">O V E R R I D E</td> <td style="text-align: center;">O V E R R I D E</td> </tr> <tr> <td style="text-align: center;">22</td> <td></td> <td></td> <td></td> <td></td> </tr> </tbody> </table>	BUFFER #	NUMBER STORED (16 CHARACTERS MAXIMUM)	TENANT #1	TENANT #2	TENANT #3	20		O V E R R I D E	O V E R R I D E	O V E R R I D E	21		A S S I G N E D	O V E R R I D E	O V E R R I D E	22					<p>BUFFERS ALREADY ASSIGNED TO A TENANT CAN BE SELECTED TO OVERRIDE CODE RESTRICTION.</p>	<p>CHECK OVERRIDE BOX IN TENANT COLUMN TO ALLOW OVERRIDE OF CODE RESTRICTION OF ASSIGNED BUFFERS.</p>
BUFFER #	NUMBER STORED (16 CHARACTERS MAXIMUM)	TENANT #1	TENANT #2	TENANT #3																		
20		O V E R R I D E	O V E R R I D E	O V E R R I D E																		
21		A S S I G N E D	O V E R R I D E	O V E R R I D E																		
22																						

# MEMORY BLOCKS 2A-2 & -3 SPEED DIAL TENANT AND OVERRIDE ASSIGNMENTS

B U F F E R #	NUMBER STORED (16 CHARACTERS MAXIMUM)	TENANT #1		TENANT #2		TENANT #3	
		A S S I G N E D	O V E R R I D E	A S S I G N E D	O V E R R I D E	A S S I G N E D	O V E R R I D E
20							
21							
22							
23							
24							
25							
26							
27							
28							
29							
30							
31							
32							
33							
34							
35							
36							
37							
38							
39							
40							
41							
42							
43							
44							
45							
46							
74							
75							
76							
77							
78							
79							
80							
81							
82							
83							
84							
85							
86							
87							
88							
89							
90							
91							
92							
93							
94							
95							
96							
97							
98							
99							
47							
48							
49							
50							
51							
52							
53							
54							
55							
56							
57							
58							
59							
60							
61							
62							
63							
64							
65							
66							
67							
68							
69							
70							
71							
72							
73							

# JOB SPECIFICATION INSTRUCTIONS FOR

## MEMORY BLOCKS 2A-1,-4,-5,-6,-7,-8,-9, 2B-1,-2,-5,-6,-9, 2C-1,-2,-3,-4 AND 3B-3,-4&8-9 SYSTEM GROUPS

### ITEM

ITEM	DESCRIPTION
2A-1	PROGRAMMING TELEPHONE
2A-4	INCOMING PRIME LINE PICKUP
2A-5	CO # AND/OR * AS FIRST DIGIT
2A-6	SMDR INCOMING REPORT
2A-7	ALL INTERNAL CALL
2A-8	ACCOUNT CODE DIGITS (1-14)
2A-9	PBX OUTGOING CODE
2B-1	KEYBOARD DIALING (MODEM)
2B-2	ALLOW FORWARD OVERRIDE
2B-5	LCR 1 + DIALING
2B-6	LCR LOCAL CALL OVERRIDE
3B-3	FORCED ACCT. CODE DIGITS (1-19)
3B-4	SLT PORT WITH RAA

### DESCRIPTION

ASSIGNING THIRD PROGRAMMING STATION  
 ALLOW PRIME LINE PICKUP IN THE SYSTEM  
 PROVIDE # AS 1st. DIGIT FOR CO DIALING  
 PROVIDE \* AS 1st. DIGIT FOR CO DIALING  
 RECORDING OF INCOMING CO INFORMATION  
 TO INCLUDE ALL STATIONS FOR INTERNAL PAGE  
 ASSIGNS LENGTH OF ACCT. CODE STREAM  
 ASSIGNS PBX OUTGOING CODES  
 ALLOWS KEYBOARD DIALING (FROM COMPUTER TERMINAL)  
 CHANGE OVERRIDE  
 SET 1 + DIALING FOR LCR, SYSTEM WIDE  
 SET TO BYPASS LCR IF 1 + IS NOT DIALED IN A  
 1 + DIAL AREA  
 SET TO BYPASS LCR  
 ASSIGNS LENGTH OF FORCED ACCT. CODE  
 ASSIGNING SLT PORT WITH RAA

### ENTRY

EXTENSION (100 ~899 or 1000 ~ 8999)  
 ✓ TO ALLOW  
 ✓ TO ALLOW  
 ✓ TO ALLOW  
 ✓ TO ALLOW  
 ✓ TO ALLOW  
 1 ~ 14 (DIGITS)  
 2 SEPARATE SINGLE DIGITS (0 ~9)  
 ✓ TO ALLOW  
 ✓ TO DENY  
 ✓ TO PROVIDE  
 ✓ TO BYPASS  
 ✓ TO BYPASS  
 1-13 (DIGITS)  
 EXTENSION (100 ~899 OR 1000 ~8999)

TRUNK ACCESS GROUP	ACCESS CODE	LCR BYPASS
1	9	✓
2	8	✓
3	70	✓
4	71	✓
5	72	✓
6	73	✓
7	74	✓
8	75	✓

### ASSIGNS TRUNK ACCESS GROUP TO BYPASS LCR

✓ TO BYPASS

TRUNK NUMBER	TELEPHONE NUMBER	TRUNK GROUP (1-8)	ITEM NUMBER (1-3)	ITEM CODE # (1-9)	POOLED LINE (1-8)
1					
2					
3					
4					

### CIRCUIT NUMBER FROM THE CO

7 ~ 10 DIGITS

### CIRCUIT ASSIGNED TO THE TRUNK GROUP

TRUNK GROUP 1 ~ 8

### CIRCUIT ASSIGNED TO TENANT

1 ~ 3

### ITEM CODE ASSIGNED TO TRUNK ACCESS

1 ~ 8

### (SEE REFERENCE TABLE)

### POOLED LINE

1 ~ 8

VOICE MAIL HUNT GROUP ASSIGNMENT	
EXTENSION #	63
	(ACCESS CODE)
	(IN DEFAULT)

**NOTE: Memory Block 2C-6 is located on page 102.**

### ASSIGNS VOICE MAIL EXTENSIONS

EXTENSION (100 ~899 or 1000 ~ 8999)



# MEMORY BLOCKS 2A-1,-4,-5,-6,-7,-8,-9, 2B-1,-2,-5,-6,-9, 2C-1,-2,-3,-4 AND 3B-3,-4 & 9 SYSTEM GROUPS

2A-1	PROGRAMMING TELEPHONE	
2A-4	INCOMING PRIME LINE PICKUP	
2A-5	CO # AS FIRST DIGIT	
2A-5	CO * AS FIRST DIGIT	
2A-6	SMDR INCOMING REPORT	
2A-7	ALL INTERNAL CALL	

2C-4	VOICE MAIL HUNT GROUP ASSIGNMENT	
EXTENSION #		<b>63</b>
		(ACCESS CODE)
		(IN DEFAULT)

2A-8	ACCOUNT CODE DIGITS (1~14)	
2A-9	PBX OUTGOING CODE	
2B-1	KEYBOARD DIALING (MODEM)	
2B-2	ALLOW FORWARD OVERRIDE	
2B-5	LCR 1 + DIALING	
2B-6	LCR LOCAL CALL OVERRIDE	
3B-3	FORCED ACCT. CODE DIGITS (1~13)	
3B-4	SLT PORT WITH RAA	

TRUNK NUMBER	TELEPHONE NUMBER	2C-1 TRUNK GROUP NUMBER (1~8)	2C-2 TENANT NUMBER (1~3)	2C-3 ITEM CODE # (1~8)	3B-9 POOLED LINE (1~8)
1					
2					
3					
4					
5					
6					
7					
8					
9					
10					
11					
12					
13					
14					
15					
16					
17					
18					
19					
20					

TRUNK ACCESS CODE GROUP	ACCESS CODE	LCR BYPASS
1	9	
2	8	
3	70	
4	71	
5	72	
6	73	
7	74	
8	75	

TRUNK NUMBER	TELEPHONE NUMBER	2C-1 TRUNK GROUP NUMBER (1~8)	2C-2 TENANT NUMBER (1~3)	2C-3 ITEM CODE # (1~8)	3B-9 POOLED LINE (1~8)
21					
22					
23					
24					
25					
26					
27					
28					
29					
30					
31					
32					
33					
34					
35					
36					
37					
38					
39					
40					

ITEM CODE NUMBER	DIAL CODE NUMBER	
	DEFAULT	NEW CODE
1	9	9
2	8	
3	70	
4	71	
5	72	
6	73	
7	74	
8	75	

# JOB SPECIFICATION INSTRUCTIONS FOR MEMORY BLOCK 2A-10 TIE LINE DIGIT RESTRICTION ASSIGNMENT

**ITEM**

**DESCRIPTION**

**ENTRY**

	NUMBER OF DIGITS THAT CAN BE DIALED	STATION NUMBER
1		
2		
3		

MAXIMUM NUMBER OF DIGITS THAT A STATION CAN DIAL WHEN USING A TIE LINE

01 ~ 99 or ?? (?? = NO RESTRICTION)

	NUMBER OF DIGITS THAT CAN BE DIALED	STATION NUMBER
1		
2		
3		

STATION BEING ASSIGNED

(100 ~ 899 OR 1000 ~ 8999)

# MEMORY BLOCK 2A-10 TIE LINE DIGIT RESTRICTION ASSIGNMENT

STATION NUMBER	NUMBER OF DIGITS THAT CAN BE DIALED
61	
62	
63	
64	
65	
66	
67	
68	
69	
70	
71	
72	
73	
74	
75	
76	
77	
78	
79	
80	

STATION NUMBER	NUMBER OF DIGITS THAT CAN BE DIALED
41	
42	
43	
44	
45	
46	
47	
48	
49	
50	
51	
52	
53	
54	
55	
56	
57	
58	
59	
60	

STATION NUMBER	NUMBER OF DIGITS THAT CAN BE DIALED
21	
22	
23	
24	
25	
26	
27	
28	
29	
30	
31	
32	
33	
34	
35	
36	
37	
38	
39	
40	

STATION NUMBER	NUMBER OF DIGITS THAT CAN BE DIALED
1	
2	
3	
4	
5	
6	
7	
8	
9	
10	
11	
12	
13	
14	
15	
16	
17	
18	
19	
20	

# JOB SPECIFICATION INSTRUCTIONS FOR MEMORY BLOCKS 2B-3, -4, -7, -8 AND 2C-5 DIT/ANA, MODEM POOL AND SLT TO VMI ASSIGNMENTS

TRUNK NUMBER	2B3 DIT/ANA TRUNK TO TENANT 1~3		2B4 DIT/ANA TO EXTENSION NUMBER		2C5 DELAY ANNOUNCE
	DAY MODE	NIGHT MODE (ANA)	DAY MODE	NIGHT MODE (ANA)	
1	(1)	(2)	(3)	(4)	(4)
2					

2B7 MODEM	ASSOCIATED EXTENSION #	ASSOCIATED SLT EXTENSION #	ITEM ASSOCIATED TERMINAL EXTENSION #
1	(5)		(6)
2			

2B8 VMI EXTENSION NUMBER	VOICE MAIL	SLT	AUTO DIAL
(7)	(8)	(9)	(10)

## DESCRIPTION ENTRY

- ① Assigns a tenant to the DIT/ANA trunk. 1 ~ 3
- ② The extension or hunt number that the DIT (day mode) is assigned to. Extension Number or Hunt Number (100~899 or 1000 ~ 8999)
- ③ The extension or hunt number that the ANA (night mode) is assigned to. Extension Number or Hunt Number (100~899 or 1000 ~ 8999 )
- ④ Delay Announcement Assignment.  To allow
- ⑤ SLT extension associated with a modem for use with the Modem Pool. Extension Number (100~899 or 1000~8999)
- ⑥ Multiline Terminal's extension number associated with a modem for use in the Modem Pool. Extension Number (100~899 or 1000~8999)
- ⑦ VMI extension number. For each VMI, extension number (100~899 or 1000~8999).
- ⑧ ⑨ Voice Mail/SLT assignment.  To select equipment type connected to each VMI extension (voice mail equipment, or single line telephone).
- ⑩ Auto Dial Assignment  To allow

**NOTE:** Memory Block 2B-10 is located on page 102.

# MEMORY BLOCKS 2B-3, -4, -7, -8 AND 2C-5 DIT/ANA, MODEM POOL AND SLT TO VMI ASSIGNMENTS

2B7

MODEM	ASSOCIATED SLT EXTENSION #	ASSOCIATED TERMINAL EXTENSION #
1		
2		
3		
4		

2B8

VMI EXTENSION NUMBER	VOICE MAIL	SLT	AUTO DIAL

TRUNK NUMBER	DIT/ANA TRUNK TO TENANT 1~3	2B4		2B3	DIT/ANA TRUNK TO TENANT 1~3	2B4		2C-5
		DAY MODE	NIGHT MODE (ANA)			DAY MODE	NIGHT MODE (ANA)	
1								
2								
3								
4								
5								
6								
7								
8								
9								
10								
11								
12								
13								
14								
15								
16								
17								
18								
19								
20								
21								
22								
23								
24								
25								
26								
27								
28								
29								
30								
31								
32								
33								
34								
35								
36								
37								
38								
39								
40								

# JOB SPECIFICATION INSTRUCTIONS FOR MEMORY BLOCKS 2C-7, -8, AND -9 RELAY ASSIGNMENTS

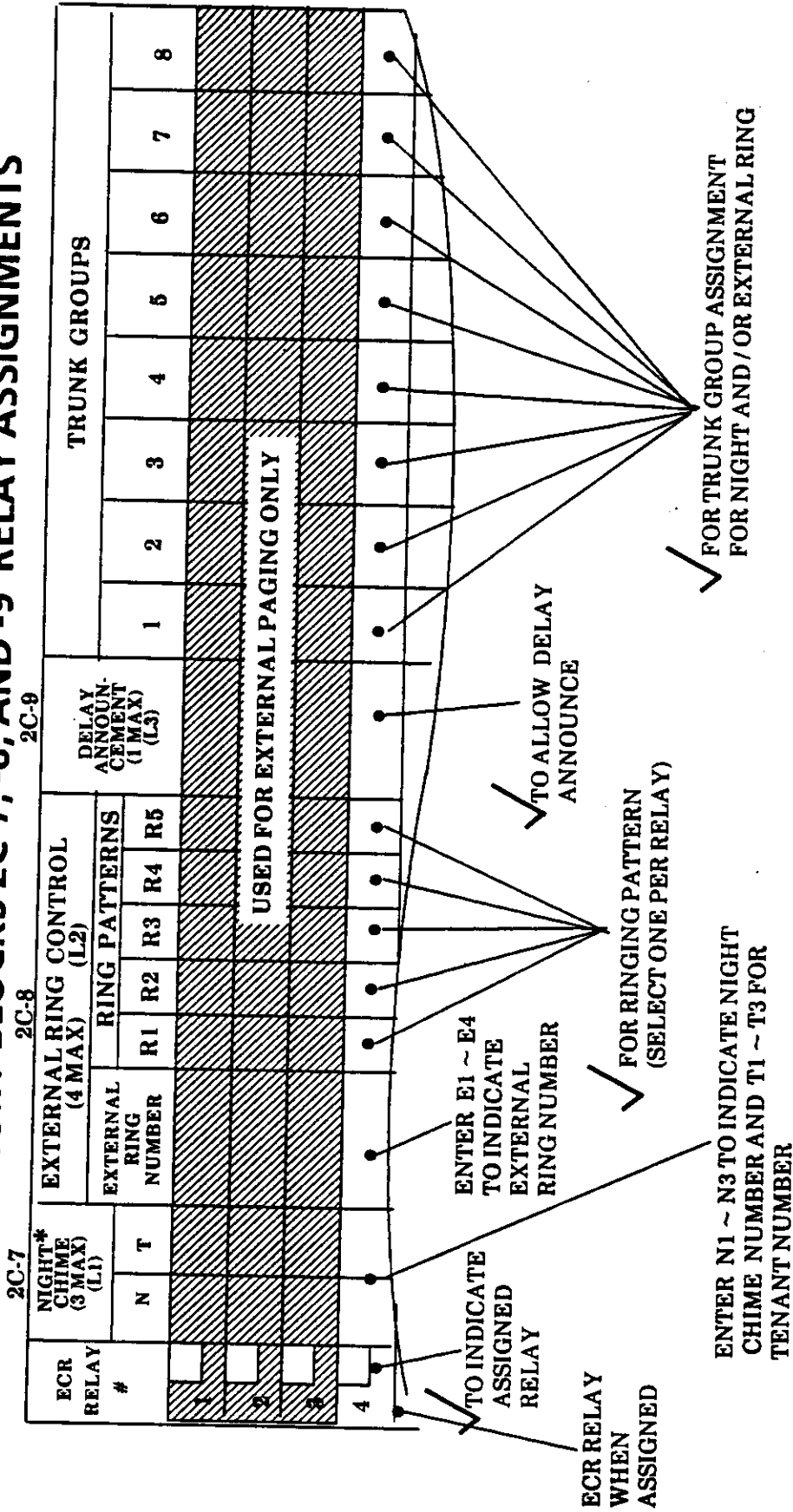

\* THE RINGING INTERVAL FOR NIGHT CHIME IS FIXED BY SYSTEM SOFTWARE AND CANNOT BE CHANGED.

# JOB SPECIFICATION INSTRUCTIONS FOR MEMORY BLOCKS 2C-7, -8, AND -9 RELAY ASSIGNMENTS

ECR RELAY #	2C-7		2C-8					2C-9	TRUNK GROUPS									
	NIGHT* CHIME (3 MAX) L1		EXTERNAL RING CONTROL (4 MAX) (L2)				DELAY ANNOU- CEMENT (1 MAX) (L3)	1	2	3	4	5	6	7	8			
	N	T	EXTERNAL RING NUMBER	R1	R2	R3	R4									R5		
1																		
2																		
3																		
4																		
5																		
6																		
7																		
8																		
9																		
10																		

\* THE RINGING INTERVAL FOR NIGHT CHIME IS FIXED BY SYSTEM SOFTWARE AND CANNOT BE CHANGED.

# JOB SPECIFICATION INSTRUCTIONS FOR MEMORY BLOCK 2C-10 VIRTUAL EXTENSION ASSIGNMENT

ITEM

DESCRIPTION

ENTRY

VE	STATIONS ASSIGNED (SEE MB1A, LK ASSIGNMENT)	
	VE #	
	DEFAULT	
	ASSIGNED	
01	200	

DEFAULT VIRTUAL EXTENSION NUMBER  
ASSIGNMENTS. ANY UNASSIGNED EXTENSION  
NUMBER CAN BE USED TO REPLACCE THE  
DEFAULT VALUE.

NEW VIRTUAL EXTENSION NUMBER  
(100 ~ 899 OR 1000 ~ 8999)

VE	STATIONS ASSIGNED (SEE MB1A, LK ASSIGNMENT)	
	VE #	
	DEFAULT	
	ASSIGNED	
01	200	

STATIONS HAVING APPEARANCES  
FOR THE PARTICULAR VIRTUAL  
EXTENSION.

PRIMARY EXTENSION (PE) NUMBER  
OF STATION ASSIGNED  
(100 ~ 899 OR 1000 ~ 8999)

NOTE: 48 VIRTUAL EXTENSIONS ARE AVAILABLE.



# MEMORY BLOCK 2C-10 VIRTUAL EXTENSION ASSIGNMENT

VE	VE #		STATIONS ASSIGNED (SEE MB1A, LK ASSIGNMENT)	VE	VE #		STATIONS ASSIGNED (SEE MB1A, LK ASSIGNMENT)	VE	VE #		STATIONS ASSIGNED (SEE MB1A, LK ASSIGNMENT)	VE	VE #		STATIONS ASSIGNED (SEE MB1A, LK ASSIGNMENT)
	DEFAULT	ASSIGNED			DEFAULT	ASSIGNED			DEFAULT	ASSIGNED			DEFAULT	ASSIGNED	
01	200			13	212			25	224			37	236		
02	201			14	213			26	225			38	237		
03	202			15	214			27	226			39	238		
04	203			16	215			28	227			40	239		
05	204			17	216			29	228			41	240		
06	205			18	217			30	229			42	241		
07	206			19	218			31	230			43	242		
08	207			20	219			32	231			44	243		
09	208			21	220			33	232			45	244		
10	209			22	221			34	233			46	245		
11	210			23	222			35	234			47	246		
12	211			24	223			36	235			48	247		

# JOB SPECIFICATION INSTRUCTIONS FOR MEMORY BLOCKS 2D-1, -2 & -3 SYSTEM TIME BASE ASSIGNMENTS

THE TIMING REQUIRED FOR EACH FEATURE

THE COUNT THAT IS MULTIPLIED BY THE BASE VALUE TO ARRIVE AT THE TIME VALUE OF EACH FEATURE

TIMER DESCRIPTION	NEW VALUE	NEW COUNT
START TIME (SMDR, ELAPSED CALL TIMER)		ENTER 1 ~ 7
CALL PARK RECALL		
DSS/BLF (ATT.) CAMP-ON/TRANS. RECALL		
RECALL (CAMP-ON/TRANS. & NON EX. HOLD)		
CANCEL AUTO CALLBACK		
CALL FORWARD NO ANSWER		ENTER 1 ~ 99
EXCLUSIVE HOLD RECALL	990	
EXTERNAL PAGE ACCESS DURATION	990	
INTERNAL PAGE ACCESS DURATION	990	
SMDR VALID CALL TIMER	990	

# MEMORY BLOCKS 2D-1, -2 & -3 SYSTEM TIME BASE ASSIGNMENTS

NOTE: BASE x COUNT = VALUE

TIMER DESCRIPTION	BASE COUNT	DEFAULT		VALUE RANGE		NEW VALUE	NEW COUNT
		VALUE	COUNT	MIN.	MAX.		
START TIME (SMR, ELAPSED CALL TIMER)	10	2	20	10	70		
CALL PARK RECALL	10	18	180	20	990		
DSS/BLF (ATT.) CAMP-ON / TRANS. RECALL	10	5	50	10	990		
RECALL (CAMP-ON / TRANS. & NON-EX. HOLD)	10	5	50	10	990		
CANCEL AUTO CALLBACK	10	2	20	10	990		
CALL FORWARD NO ANSWER	10	2	20	10	990		
EXCLUSIVE HOLD RECALL	10	6	60	10	990		
EXTERNAL PAGE ACCESS DURATION	10	30	300	10	990		
INTERNAL PAGE ACCESS DURATION	10	6	60	10	990		
SMR VALID CALL TIMER	10	4	40	10	990		
MODEM RESERVE TIMER	10	60	600	10	990		
DELAY ANNOUNCEMENT END	10	60	600	10	990		
CONFERENCE PARK RECALL	10	30	300	10	990		
MFR TIME OUT	1	10	10	1	99		
TALK START TIMER	1	18	18	1	99		
DELAY ANNOUNCEMENT START	1	20	20	1	99		
VOICE MAIL DIAL START	1	2	2	1	99		
CO DELAYED RING	1	10	10	1	99		
EXTENSION DELAYED RING	1	10	10	1	99		
	SEC.		SEC.	SEC.	SEC.	SEC.	SEC.

2D-3	AUTOMATIC DISCONNECT TIMER	10	6	60	10	990	
		MIN.		MIN.	MIN.	MIN.	

# JOB SPECIFICATION INSTRUCTIONS FOR MEMORY BLOCK 2E-1 SYSTEM ACCESS CODES

ITEM	DESCRIPTION	ENTRY
FEATURE		
BGM OVER STATION SPEAKER	3	49
CALL FWD. ALL/ORIGINATOR	4	41
CALL FWD. ALL/TARGET	5	47
CALL FWD. ALL/ATTENDANT		
	NEW FEATURE ACCESS CODE DESIRED	ANY UNUSED CODE PATTERN

# MEMORY BLOCK 2E-1 SYSTEM ACCESS CODES

FEATURE	ITEM	DEFAULT CODE	NEW CODE
BGM OVER STATION SPEAKER	3	49	
CALL FWD. ALL/ORIGINATOR	4	41	
CALL FWD. ALL/DESTINATION	5	47	
CALL FWD. ALL/ATTENDANT	6	44	
CALL FWD. BUSY NO ANS/ORIGINATOR	7	42	
CALL FWD. BUSY NO ANS/DESTINATION	8	48	
CALL FWD. BUSY NO ANS/ATTENDANT	9	45	
CALL PARK	13	4*	
CALL PICKUP/DIRECTED	14	6#	
CALL PICKUP/GROUP	15	6*	
EXTERNAL HOLD SLT SET/RETRIEVE	17	4#	
INTERNAL PAGE	23	55	
EXTERNAL PAGE	24	56	
NIGHT CALL PICKUP	26	60	
NIGHT MODE	27	68	
STATION SPEED DIAL - SLT PROGRAM	29	58	
STATION LOCKOUT	30	61	
STATION LOCKOUT CANCEL/ATTENDANT	31	62	
SPECIAL CODE PROGRAM	32	59	
TRUNK AND MFR SELECT/TEST	34	67	
TRUNK AND MFR BUSYOUT/RESTORE	35	57	
EXTENSION NUMBER	36	1	
EXTENSION NUMBER	37	2	
EXTENSION NUMBER	38	3	
TRUNK ACCESS CODE 2	39	8	
TRUNK ACCESS CODE 3	40	70	
TRUNK ACCESS CODE 4	41	71	
TRUNK ACCESS CODE 5	42	72	
TRUNK ACCESS CODE 6	43	73	
TRUNK ACCESS CODE 7	44	74	
TRUNK ACCESS CODE 8	45	75	
AUTOMATIC CALLBACK/TRUNK QUEUE	46	*1	

FEATURE	ITEM	DEFAULT CODE	NEW CODE
CALL BACK REQUEST MESSAGE	47	1#	
TOPE/ATTENDANT OVERRIDE	50	1*0	
UNIFORM DIAL	60	NONE	
UNIFORM DIAL	61	NONE	
UNIFORM DIAL	62	NONE	
UNIFORM DIAL	63	NONE	
UNIFORM DIAL	64	NONE	
UNIFORM DIAL	65	NONE	
UNIFORM DIAL	66	NONE	
UNIFORM DIAL	67	NONE	
UNIFORM DIAL	68	NONE	
UNIFORM DIAL	69	NONE	
UNIFORM DIAL	70	NONE	
UNIFORM DIAL	71	NONE	
UNIFORM DIAL	72	NONE	
UNIFORM DIAL	73	NONE	
UNIFORM DIAL	74	NONE	
UNIFORM DIAL	75	NONE	
UNIFORM DIAL	76	NONE	
UNIFORM DIAL	77	NONE	
UNIFORM DIAL	78	NONE	
UNIFORM DIAL	79	NONE	
VOICE MAIL HUNT	90	163	
VOICE MAIL MESSAGE WAITING	91	154	
HOOKFLASH TO CO FOR SLTs	92	NONE	
CO PRIME LINE RELEASE FOR SLTs	93	NONE	
ACCOUNT CODE - FORCED/VERIFIED	94	NONE	

# JOB SPECIFICATION INSTRUCTIONS FOR MEMORY BLOCK 2E-1 SYSTEM ACCESS CODES

ITEM	DESCRIPTION	ENTRY
FEATURE		
BGM OVER STATION SPEAKER	3	49
CALL FWD. ALL/ORIGINATOR	4	41
CALL FWD. ALL/TARGET	5	47
CALL FWD. ALL/ATTENDANT		
	NEW FEATURE ACCESS CODE DESIRED	•
		ANY UNUSED CODE PATTERN

# MEMORY BLOCK 2E-1 SYSTEM ACCESS CODES

FEATURE	ITEM	DEFAULT CODE	NEW CODE
ATTENDANT CALL		0	<div style="text-align: center;"> <b>FIXED</b> </div>
TRUNK ACCESS CODE 1		.9	
LAST NUMBER REDIAL		*	
OFF-LINE FOR PROGRAMMING		*#0	
SPEED DIAL		#0	
SPEED DIAL		#1	
SPEED DIAL		#2	
SPEED DIAL		#3	
SPEED DIAL		#4	
SPEED DIAL		#5	
SPEED DIAL		#6	
SPEED DIAL		#7	
SPEED DIAL		#8	
SPEED DIAL		#9	
INTERNAL VOICE/RING		1	
CALL BACK REQUEST/RETRIEVE		1	
ACCOUNT CODE ENTRY		##	
CALL BACK REQUEST/CANCEL		*	

# JOB SPECIFICATION INSTRUCTIONS FOR MEMORY BLOCKS 3A-2, -3, -4, AND 3C-1, -2

## ITEM

### DESCRIPTION

### ENTRY

ATT. NUMBER	3A-2 STATION NUMBER ASSIGNMENT	3A-3 ATT. OVER-FLOW	3A-4 ATT. TO TENANT (1-3)
1		●	●
2		●	
3			
4			

TENANT NUMBER ATTENDANT IS ASSIGNED TO

1 ~ 3

DESTINATION ATTENDANT DURING OVERFLOW CONDITIONS

1 ~ 4

ASSIGNMENT OF THE 3rd. & 4th. ATTENDANT

✓ FOR ASSIGNED

STATION NUMBER	NAME (7 DIGITS MAX.)
1	
2	
3	
4	
5	
6	
7	

STATION NUMBER ASSIGNED TO ATTENDANT

100 ~ 899 or 1000 ~ 8999

UP TO 7 CHARACTERS, NAME ASSIGNED TO STATION

A ~ Z, 0 ~ 9, \*, # AND SPACE

STATION NUMBER BEING ASSIGNED A NAME

100 ~ 899 or 1000 ~ 8999

TRUNK GROUP	NAME (8 DIGITS MAX.)
1	
2	
3	
4	
5	
6	
7	
8	

UP TO 8 CHARACTERS, NAME ASSIGNED TO A TRUNK GROUP

A ~ Z, 0 ~ 9, \*, # AND SPACE

TRUNK GROUP BEING ASSIGNED A NAME

1 ~ 8





# JOB SPECIFICATION INSTRUCTIONS FOR

## MEMORY BLOCKS 3B-1, -2, -5, -6, -7, & -8 CENTREX RINGING AND STATION HUNTING ASSIGNMENT

ITEM

DESCRIPTION

ENTRY

TRUNK GROUP	FIRST RING PATTERN
1	
2	
3	
4	
5	
6	
7	
8	

TRUNK GROUP	CENTREX RING
1	
2	
3	
4	
5	
6	
7	
8	

FIRST RING PATTERN

CENTREX RING

LEAVE BLANK FOR 2 SEC. ON  
4 SEC. OFF

- OR -

CHECK OFF BOX FOR .5 SEC.  
ON .5 SEC OFF. (1HZ RING)

HUNT GROUP	1	2	3	4	5	6	7	8
PILOT NUMBER								
HUNT TYPE								
GROUP FORWARD								
	1							
	2							
	3							
	4							
	5							
	6							
	7							
	8							
	9							
	10							
	11							
	12							
	13							
	14							
	15							
	16							

ASSIGN HUNT PILOT NUMBER  
TO HUNT GROUP

100~899 or 1000~8999

ASSIGNS HUNT SEARCH  
METHOD TO HUNT GROUP

LINEAR (L)  
CIRCULAR (C)

ASSIGNS FORWARD DESTINATION  
NUMBERS TO HUNT GROUP

100~899 or 1000~8999

ASSIGNS HUNT GROUP  
NUMBERS TO HUNT GROUP

100~899 or 1000~8999

3B-5

3B-7

3B-8

3B-6

**JOB SPECIFICATION INSTRUCTIONS  
FOR  
MEMORY BLOCKS 3B-1, -2, -5, -6, -7, & -8 CENTREX RINGING  
AND STATION HUNTING ASSIGNMENT**

**3B-1**

TRUNK GROUP	FIRST RING PATTERN
1	
2	
3	
4	
5	
6	
7	
8	

**3B-2**

TRUNK GROUP	CENTREX RING
1	
2	
3	
4	
5	
6	
7	
8	

HUNT GROUP	1	2	3	4	5	6	7	8
PILOT NUMBER								
HUNT TYPE								
GROUP FORWARD								
1								
2								
3								
4								
5								
6								
7								
8								
9								
10								
11								
12								
13								
14								
15								
16								

3B-5

3B-7

3B-8

3B-6

H U N T  
M E M B E R

# JOB SPECIFICATION INSTRUCTIONS FOR

## MEMORY BLOCKS 3E-1, -2, -3, -4, AND -10 SYSTEM RESTRICTIONS

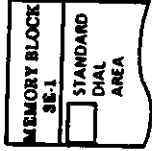
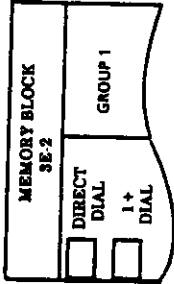
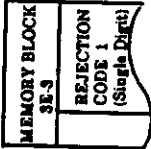
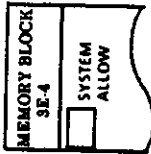
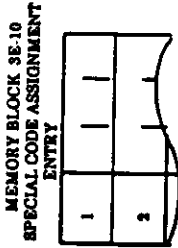
ITEM	DESCRIPTION	ENTRY
	TYPE OF DIALING AVAILABLE IN THE AREA.	✓ APPROPRIATE TYPE (ONE ONLY)
	DIALING METHODS USED FOR TOLL CALLING	✓ APPROPRIATE TYPE (ONE ONLY) FOR EACH TRUNK GROUP
	REJECTION OF FIRST DIGIT DIALED	1 ~ 9 IN EACH OF THE FOUR BOXES
	CHOICE OF ALLOW OR DENY OF DIGITS DIALED THAT DO NOT MATCH THE CODES ENTERED IN THE RESTRICTION TABLE ASSIGNMENTS IN MEMORY BLOCK 1D-6	✓ CHOICE
	WHEN PUERTO RICO IS SELECTED IN MEMORY BLOCK 3E-1 (ENTER ALL EIGHT 3 DIGIT LONG DISTANCE CODES). (REPLACES TABLE 32 IN MEMORY BLOCK 3E-8)	3 DIGIT CODES

# MEMORY BLOCKS 3E-1, -2, -3, -4, AND -10 SYSTEM RESTRICTIONS

MEMORY BLOCK 3E-1	MEMORY BLOCK 3E-2	MEMORY BLOCK 3E-3	MEMORY BLOCK 3E-4	MEMORY BLOCK 3E-10 SPECIAL CODE ASSIGNMENT ENTRY
<input type="checkbox"/> STANDARD DIAL AREA	DIRECT DIAL <input type="checkbox"/> 1+ DIAL <input type="checkbox"/> TRUNK GROUP 1	REJECTION CODE 1 (Single Digit)	<input type="checkbox"/> SYSTEM ALLOW	1
<input type="checkbox"/> INDEPENDENT TELEPHONE COMPANY	DIRECT DIAL <input type="checkbox"/> 1+ DIAL <input type="checkbox"/> TRUNK GROUP 2	REJECTION CODE 2 (Single Digit)	<input type="checkbox"/> SYSTEM DENY	2
<input type="checkbox"/> PUERTO RICO	DIRECT DIAL <input type="checkbox"/> 1+ DIAL <input type="checkbox"/> TRUNK GROUP 3	REJECTION CODE 3 (Single Digit)		3
	DIRECT DIAL <input type="checkbox"/> 1+ DIAL <input type="checkbox"/> TRUNK GROUP 4	REJECTION CODE 4 (Single Digit)		4
	DIRECT DIAL <input type="checkbox"/> 1+ DIAL <input type="checkbox"/> TRUNK GROUP 5			5
	DIRECT DIAL <input type="checkbox"/> 1+ DIAL <input type="checkbox"/> TRUNK GROUP 6			6
	DIRECT DIAL <input type="checkbox"/> 1+ DIAL <input type="checkbox"/> TRUNK GROUP 7			7
	DIRECT DIAL <input type="checkbox"/> 1+ DIAL <input type="checkbox"/> TRUNK GROUP 8			8

# JOB SPECIFICATION INSTRUCTIONS FOR

## MEMORY BLOCKS 3E-5, -6, -7, -8, & -9 SYSTEM RESTRICTIONS

ITEM	DESCRIPTION	ENTRY
3E5	TABLE NUMBER FOR ASSIGNMENTS AND REFERENCE	1 ~ 32
3E6	TABLE FUNCTION; ALLOWS OR DENIES TABLE ENTRIES	ALLOW OR DENY
3E7	UP TO FOUR (OF EIGHT AVAILABLE) TRUNK GROUPS CAN BE ASSIGNED TO EACH TABLE	1 ~ 8
3E8	ALLOWS INSPECTION OF TABLE DURING EQUAL ACCESS DIALING	SET OR NOT SET
3E9	ASSIGNMENT OF TWO OTHER COMMON CARRIERS  PERMITS UP TO SIX DIGIT CODES FOR ALLOW OR DENY; CAN BE SET FOR ONLY AREA CODES (3 DIGITS), ONLY OFFICE CODES (3 DIGITS), OR A COMBINATION OF BOTH (6 DIGITS) ALSO, 3 DIGIT OFFICE CODES FOR ALL AREA CODES; AS IN XXX976	3 DIGIT CARRIER CODE
		3 OR 6 DIGIT CODES

MEMORY BLOCK	CODE TABLE NUMBER	ALLOW/DENY	TRUNK GROUP	OCC FLAG	OCC CODE ASSIGNMENT	NO.	AREA CODE	OFFICE CODE
3E5						1		
3E6	1	2	3	4		2		
3E7						1		
3E8						2		
3E9					C	1		
					O	2		
					D	3		
					E	4		
						5		
						6		
						7		
						8		

# MEMORY BLOCKS 3E-5, -6, -7, -8, & -9 SYSTEM RESTRICTIONS

MEMORY BLOCK	CODE TABLE NUMBER 01			
3E5	ALLOW/DENY			
3E6	TRUNK GROUP			
3E7	OCC FLAG			
3E8	OCC CODE ASSIGNMENT			
3E9	C			
	O			
	D			
	E			
	NO.	AREA CODE	OFFICE CODE	
	1			
	2			
	3			

MEMORY BLOCK	CODE TABLE NUMBER 02			
3E5	ALLOW/DENY			
3E6	TRUNK GROUP			
3E7	OCC FLAG			
3E8	OCC CODE ASSIGNMENT			
3E9	C			
	O			
	D			
	E			
	NO.	AREA CODE	OFFICE CODE	
	1			
	2			
	3			

MEMORY BLOCK	CODE TABLE NUMBER 03			
3E5	ALLOW/DENY			
3E6	TRUNK GROUP			
3E7	OCC FLAG			
3E8	OCC CODE ASSIGNMENT			
3E9	C			
	O			
	D			
	E			
	NO.	AREA CODE	OFFICE CODE	
	1			
	2			
	3			

MEMORY BLOCK	CODE TABLE NUMBER 04			
3E5	ALLOW/DENY			
3E6	TRUNK GROUP			
3E7	OCC FLAG			
3E8	OCC CODE ASSIGNMENT			
3E9	C			
	O			
	D			
	E			
	NO.	AREA CODE	OFFICE CODE	
	1			
	2			
	3			

MEMORY BLOCK	CODE TABLE NUMBER 05			
3E5	ALLOW/DENY			
3E6	TRUNK GROUP			
3E7	OCC FLAG			
3E8	OCC CODE ASSIGNMENT			
3E9	C			
	O			
	D			
	E			
	NO.	AREA CODE	OFFICE CODE	
	1			
	2			
	3			

MEMORY BLOCK	CODE TABLE NUMBER 06			
3E5	ALLOW/DENY			
3E6	TRUNK GROUP			
3E7	OCC FLAG			
3E8	OCC CODE ASSIGNMENT			
3E9	C			
	O			
	D			
	E			
	NO.	AREA CODE	OFFICE CODE	
	1			
	2			
	3			

# JOB SPECIFICATION INSTRUCTIONS FOR MEMORY BLOCKS 4B-1 AND -2 COI INITIALIZED VALUES

## ITEM

MEMORY BLOCK	4B-1							
ITEM	10 PPS OR 20 PPS	DTMF OR DP	CO OR PBX	CO DISC. SIG.	DTMF LENGTH (mS.)	CO HOOK FLASH (mS.)		
DEFAULT	10 PPS	DTMF	CO	NO	110	1500		
1	●	●	●	●	●	●		
2	●	●	●	●	●	●		

4B-2			
HIT PROTECT TIME (mS.)	DISCONNECT RECOGN. TIME (mS.)	PAUSE TIME (mS.)	INTER-DIGITAL TIME (mS.)
350	300	1000	70
●	●	●	●

## DESCRIPTION

## ENTRY

TIMING OF CO/PBX HOOK FLASH FROM THE RECALL KEY OF A MULTILINE TERMINAL TO THE CO

300 ~ 1700 (100 mS. increments)

DURATION OF A DIALED DTMF DIGIT

60 ~ 760 (50 mS. increments)

DISCONNECT SIGNAL FROM CO

YES OR NO

CO OR PBX

DTMF OR DP

SELECT EITHER PUSHBUTTON OR ROTARY DIALING, DEPENDING ON CO/PBX CAPABILITY AND CUSTOMER REQUIREMENTS

SELECT THE PULSE RATE USED FOR ROTARY DIALING, DEPENDING UPON CO TYPE

10 OR 20

THE TIME DURATION BETWEEN EACH DIGIT DIALED

40 ~ 180 (10 mS. increments)

DURATION OF SPEED DIAL PAUSES

0 ~ 7000 (500 mS. increments)

RELEASE TIME OF A CO LINE

0 ~ 1400 (100 mS. increments)

DETECTION TIMING OF THE CO DISCONNECT SIGNAL

0 ~ 700 (50 mS. increments)



# MEMORY BLOCKS 4B-1 AND -2 COI INITIALIZED VALUES

MEMORY BLOCK	4B-1										4B-2			
	10 PPS OR 20 PPS	DTMF OR DP	CO OR PBX	CO OR DISC. SIGNAL	DTMF LENGTH (mS.)	CO HOOK FLASH (mS.)	HIT PROTECT TIME (mS.)	DISCONNECT RECOGN. TIME (mS.)	PAUSE TIME (mS.)	INTER-DIGITAL TIME (mS.)				
DEFAULT	10 PPS	DTMF	CO	NO	110	1500	350	300	1000	70				
1														
2														
3														
4														
5														
6														
7														
8														
9														
10														
11														
12														
13														
14														
15														
16														
17														
18														
19														
20														

MEMORY BLOCK	4B-1										4B-2			
	10 PPS OR 20 PPS	DTMF OR DP	CO OR PBX	CO OR DISC. SIGNAL	DTMF LENGTH (mS.)	CO HOOK FLASH (mS.)	HIT PROTECT TIME (mS.)	DISCONNECT RECOGN. TIME (mS.)	PAUSE TIME (mS.)	INTER-DIGITAL TIME (mS.)				
DEFAULT	10 PPS	DTMF	CO	NO	110	1500	350	300	1000	70				
21														
22														
23														
24														
25														
26														
27														
28														
29														
30														
31														
32														
33														
34														
35														
36														
37														
38														
39														
40														

# JOB SPECIFICATION INSTRUCTIONS FOR MEMORY BLOCKS 4B-3, -4, -6, -7, -8, AND -9

## ITEM

## DESCRIPTION

## ENTRY

**MEMORY BLOCKS 4B-3 AND 4B-8**

TIMER	DEFAULT	NEW (mS.)
HOOK FLASH START TIME	300 mS.	•
HOOK FLASH END TIME	1000 mS.	•
BOUNCE PROTECT TIME	300 mS.	•

MINIMUM TIME BEFORE SINGLE LINE TELEPHONE HOOK FLASH IS RECOGNIZED  
 MAXIMUM TIME SINGLE LINE TELEPHONE HOOK FLASH IS RECOGNIZED  
 LAPSED TIME AFTER HOOK FLASH BEFORE DETECTING ON-HOOK CONDITION

100 ~ 800 (50 mS. increments)

HOOK FLASH START TIME ~ 2200 (100 mS. increments)

0 ~ 1400 (100 mS. increments)

**MEMORY BLOCK 4B-4**

NO.	STA. NBR.	MOD. (1-3)	SLOT (1-8)	CH. (1-4)	DUAL PATH	DATA
1	•	•	•	•	•	•
2	•	•	•	•	•	•

✓ IF PROVIDED

✓ IF PROVIDED

1 ~ 4

1 ~ 8

1 ~ 3

100 ~ 899 OR 1000 ~ 8999

**MEMORY BLOCK 4B-5**

DEFAULT	10 PPS	DTMF	CO	NO.	110	1500
ITEM	10 PPS (or) 20 PPS	DTMF (or) DP	CO (or) PBX	CO DISC.	DTMF LENGTH (mS.)	CO-HOOK FLASH (mS.)
1	•	•	•	•	•	•
2	•	•	•	•	•	•

DURATION OF CO HOOK FLASH (RECALL KEY) SIGNAL.

300 ~ 1700 (100 mS. increments)

DURATION OF EACH PUSHBUTTON DIGIT

60 ~ 760 (50 mS. increments)

DISCONNECT SIGNAL FROM CO

YES OR NO

TYPE OF LINE

CO OR PBX

TYPE OF DIALING SCHEME OF CO

DTMF OR DP

SPEED OF ROTARY PULSES SENT TO CO

10 OR 20 PPS

INTERDIGIT INTERVAL DIALING TIME

40 ~ 180 (10 mS. increments)

SPEED DIAL PAUSE TIME

0 ~ 7000 (500 mS. increments)

CO DISCONNECT RECOGNITION TIME

0 ~ 1400 (100 mS. increments)

CO LINE HIT PROTECTION TIME

0 ~ 700 (50 mS. increments)

INTERDIGIT INTERVAL DIALING TIME

40 ~ 180 (10 mS. increments)

SPEED DIAL PAUSE TIME

0 ~ 7000 (500 mS. increments)

DISCONNECT TIME

500 ~ 3300 (200 mS. increments)

DURATION OF EACH PUSHBUTTON DIGIT

60 ~ 760 (50 mS. increments)

**MEMORY BLOCK 4B-7**

350	300/1500	1000	70
ITEM	H.P. TIME (mS.)	D RDT TIME (mS.)	PAUSE TIME (mS.)
1	•	•	•
2	•	•	•
3	•	•	•
4	•	•	•

**VMI INITIALIZE 2 (Memory Block 4B9)**

DEFAULT	110	1500	1000	70
ITEM	DTMF DURATION (mS.)	DISCONNECT TIME (mS.)	PAUSE TIME (mS.)	IDI TIME (mS.)
1	•	•	•	•
2	•	•	•	•
3	•	•	•	•
4	•	•	•	•

# COI(GROUP) INITIALIZED VALUES

MEMORY BLOCKS				4B-6				4B-7			
DEFAULT	10 PPS (or) 20 PPS	DTMF (or) DP	CO (or) PBX	NO	DTMF LENGTH (ms.)	CO HOOK FLASH (ms.)	H.P. TIME (ms.)	350	300	1000	70
ITEM				DISC.					D.R. TIME (ms.)	PAUSE TIME (ms.)	IDI TIME (ms.)
1											
2											
3											
4											
5											
6											
7											
8											

### VMI INITIALIZE 1 (MEMORY BLOCK 4B-8)

TIMER	DEFAULT	NEW (mS.)
HOOK FLASH START TIME	300 mS.	
HOOK FLASH END TIME	1000 mS.	
BOUNCE PROTECT TIME	300 mS.	

### VMI INITIALIZE 2 (MEMORY BLOCK 4B-9)

DEFAULT	110	1500	1000	70
ITEM	DTMF DURATION (ms.)	DISCONNECT TIME (ms.)	PAUSE TIME (ms.)	IDI TIME (ms.)
1				
2				
3				
4				

\* NOTE: Only channels 1 and 3 can be assigned for both dual voice path and data in one ESI-EB card. Channels 2 and 4 must then be set for single voice only.

## ESI-EB DATA AND SECOND VOICE PATH ASSIGNMENT \* (MEMORY BLOCK 4B-4)

NO.	STA. NBR.	MOD. (1-3)	SLOT (1-8)	CH. (1-4)	DUAL PATH	DATA
1						
2						
3						
4						
5						
6						
7						
8						
9						
10						
11						
12						
13						
14						
15						
16						
17						
18						
19						
20						
21						
22						
23						
24						
25						
26						
27						
28						
29						
30						
31						
32						
33						
34						
35						
36						
37						
38						
39						
40						
41						
42						
43						
44						
45						
46						
47						
48						
49						
50						
51						
52						
53						
54						
55						
56						
57						
58						
59						
60						
61						
62						
63						
64						
65						
66						
67						
68						
69						
70						
71						
72						
73						
74						
75						
76						
77						
78						
79						
80						

# JOB SPECIFICATION INSTRUCTIONS FOR MEMORY BLOCK 4C-1 CARD INTERFACE SLOT ASSIGNMENT

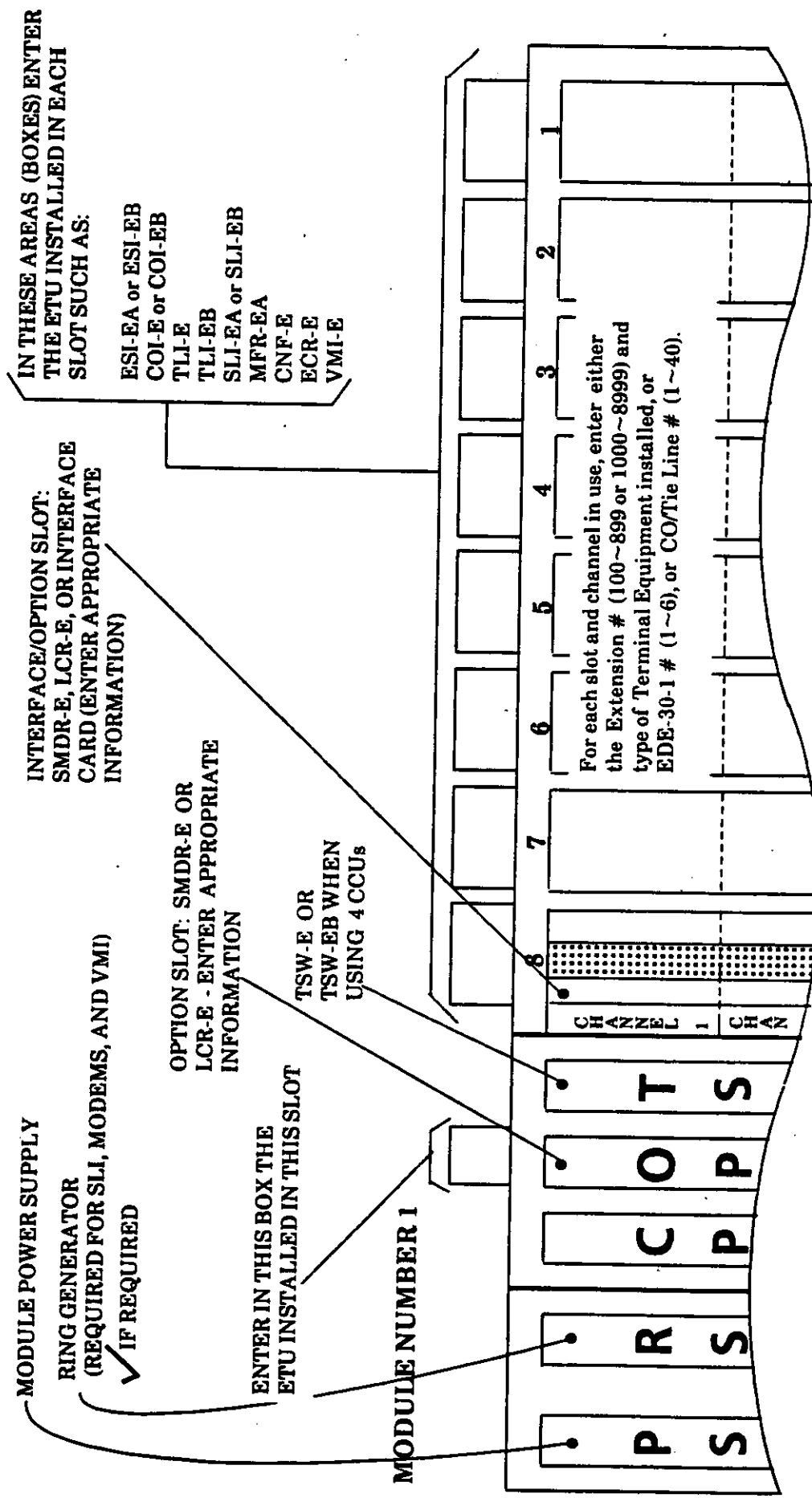

# MEMORY BLOCK 4C-1 CARD INTERFACE SLOT ASSIGNMENT

MODULE NUMBER 1

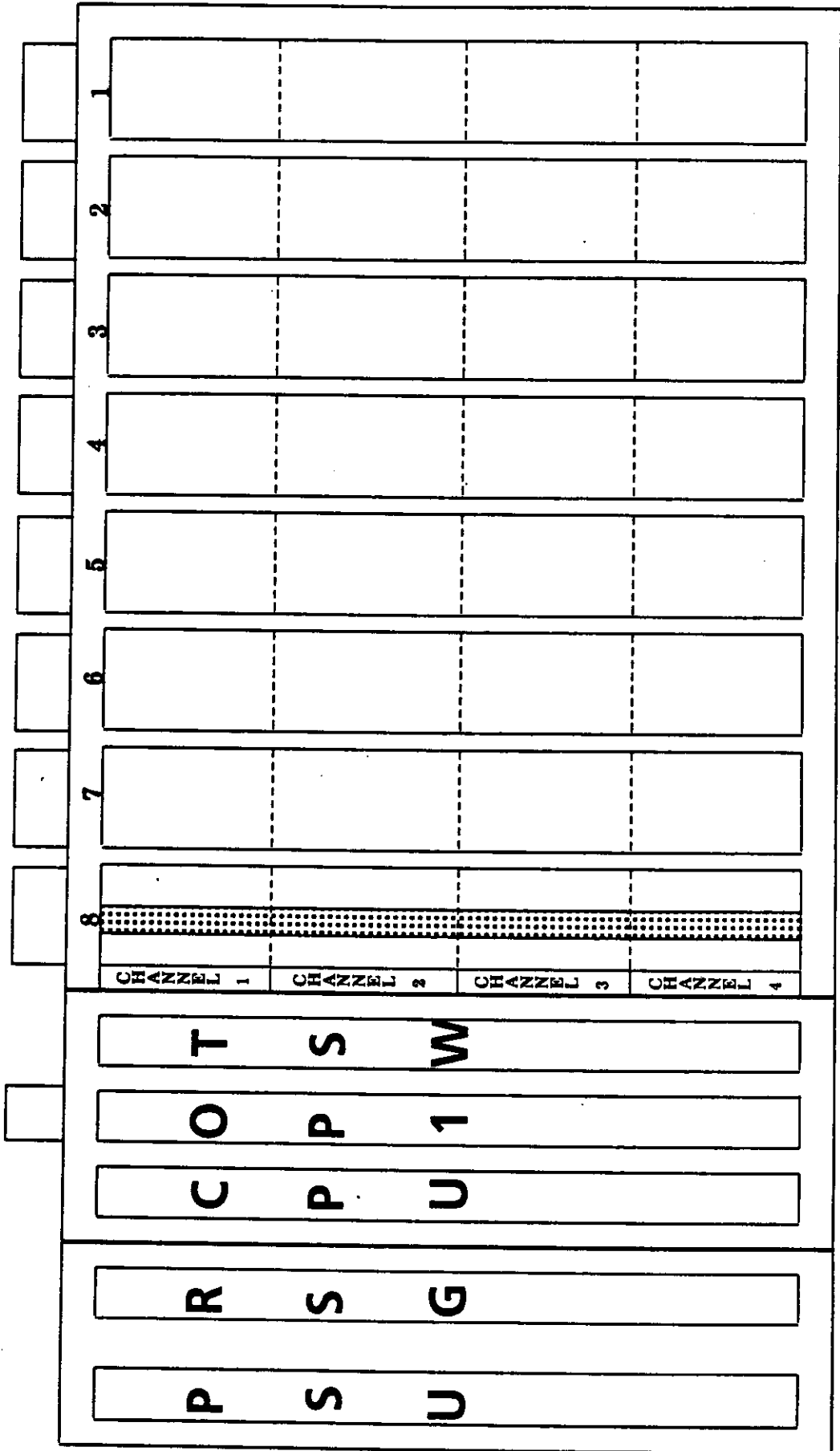

# JOB SPECIFICATION INSTRUCTIONS FOR MEMORY BLOCKS 4E-1, -2, AND -3 TLI LINE AND SIGNALING PARAMETERS

TRUNK GROUP	LINE TYPE	4E1 TLI LINE TYPE ASSIGNMENT				4E2 TLI LINE DIAL TONE ASSIGNMENT		4E3 TLI DIGIT ADD/DELETE ASSIGNMENT		
		SECOND DIAL TONE	IMMEDIATE START	DELAY DIAL	WINK START	DISTANT END (L1)	SYSTEM END (L2)	NUMBER OF DIGITS TO BE DELETED 1~3		
								1st	2nd	3rd
1	E&M Tie Line	1	2	3	4	5	6		8	
	DID									
2	E&M Tie Line									
	DID									

## DESCRIPTION

## ENTRY

- ① ~ ③ Type of line supervision provided.  Type assigned
- ④ Dial tone provided to distant end of E&M Tie Line  If provided
- ⑤ Dial tone provided to system end of E&M Tie Line  If provided
- ⑥ Number of digits to be deleted. 1~3
- ⑦ Number of digits to be added. 0~9 for each (up to 3) digit to be added

# MEMORY BLOCKS 4E-1, -2, AND -3 TLI LINE AND SIGNALING PARAMETERS

TRUNK GROUP	LINE TYPE	4E-1 TLI LINE TYPE ASSIGNMENT				4E-2 TLI LINE DIAL TONE ASSIGNMENT		4E-3 TLI DIGIT ADD/DELETE ASSIGNMENT			
		SECOND DIAL TONE	IMMEDIATE START	DELAY DIAL	WINK START	DISTANT END (L1)	SYSTEM END (L2)	NUMBER OF DIGITS TO BE DELETED 1 ~ 3	1st	2nd	3rd
1	E&M Tie Line										
	DID										
2	E&M Tie Line										
	DID										
3	E&M Tie Line										
	DID										
4	E&M Tie Line										
	DID										
5	E&M Tie Line										
	DID										
6	E&M Tie Line										
	DID										
7	E&M Tie Line										
	DID										
8	E&M Tie Line										
	DID										

# JOB SPECIFICATION INSTRUCTIONS FOR MEMORY BLOCKS 4E-4, -5, AND -6 TLI INITIALIZED VALUES

## ITEM

## DESCRIPTION

## ENTRY

- 1 DURATION OF FORCED GROUND BETWEEN PULSED DIGITS.
- 2 LAPSED TIME BEFORE SENDING PULSED DIGITS TO CO AFTER DISTANT END GOES OFF-HOOK.
- 3 MINIMUM TIME INTERVAL AFTER THE CALLED PARTY ANSWERS BEFORE A CONVERSATION MAY START.
- 4 MINIMUM TIME AFTER HANGING UP BEFORE M LEAD RECOGNIZES A DISCONNECT FROM THE CO.
- 5 TIME DURATION LAPSED BEFORE RECOGNIZING AN OFF-HOOK CONDITION FROM THE CO WITH A DELAY OR WINK SIGNAL.
- 6 LAPSED TIME AFTER LOCAL STATION ANSWERS BEFORE A VOICE PATH IS ESTABLISHED.
- 7 LENGTH OF WINK SIGNAL SEND TO THE DISTANT END.
- 8 LENGTH OF DELAY SIGNAL SEND TO THE DISTANT END.
- 9 THE LENGTH OF TIME, IN SECONDS, THAT THE SYSTEM WILL MONITOR THE CENTRAL OFFICE LINE FOR RECEIPT OF A WINK SIGNAL.
- 10 LENGTH OF TIME THE SYSTEM WILL NOT ORIGINATE AFTER HANGING UP.
- 11 WHEN USING A TANDEM PORT, THE MAXIMUM TIME BEFORE THE VOICE PATH IS ESTABLISHED, AFTER DIALING THE FIRST DIGIT, AND BETWEEN EACH DIGIT DIALED.

0 ~ 7000 mS. (500mS. INCREMENTS).

0 ~ 12 SECONDS (0~2 SECONDS IN 500 mS. INCREMENTS; 2~12 IN 1 SECOND INCREMENTS).

0 ~ 1820 mS. (130mS. INCREMENTS).

0 ~ 1820 mS. (130mS. INCREMENTS).

FOR WINK START = 0~1820mS. (130 mS. INCREMENTS)

FOR DELAY DIALING = 0~420mS. (30mS. INCREMENTS)

0~12 SECONDS (FROM 0~2 SECONDS IN 500 mS. INCREMENTS; FROM 2~12 SECONDS IN 1 SECOND INCREMENTS).

30mS. ~ 450 mS. (30mS. INCREMENTS)

0 ~ 4200 mS. (300mS. INCREMENTS)

1 ~ 14 SECOND OR ∞ (1~14 SECONDS IN 1 SECOND INCREMENTS).

1 ~ 9 SECONDS

2 ~ 28 SECONDS OR ∞ (2~28 SECONDS IN 2 SECOND INCREMENTS).

4E-4					
MEMORY BLOCK	ITEM	PAUSE TIME	PRE-PULSE TIME	CO ANSWER DETECT	CO RELEASE DETECT
DEFAULT		1000 mS.	3 sec.	520 mS.	520 mS.
T	1	(1)	(2)	(3)	(4)
R	2				
J					

4E-5				
WINK/DELAY INCOMING DETECT TIME	LOOP OFF-GUARD TIME	LENGTH OF WINK SIGNAL	LENGTH OF DELAY SIGNAL	
520 mS.	2 sec.	180 mS.	300 mS.	
120mS.	(6)	(7)	(8)	(5)

4E-6			
WINK/DELAY SIGNAL DETECT TIMEOUT	OUTGOING GUARD TIME	TANDEM RESTRICTION / LCR TIMER	
7 sec.	3 sec.	12 sec.	
(9)	(10)	(11)	



# MEMORY BLOCKS 4E-4, -5, AND -6 TLI INITIALIZED VALUES

MEMORY BLOCK	4E-4					4E-5				4E-6		
	PAUSE TIME (0 - 7000 mS.)	PRE-PAUSE TIME (0 - 12 SEC.)	CO ANSWER DETECT TIME (0 - 1820 mS.)	CO RELEASE DETECT TIME (0 - 1820 mS.)	WINK <sup>1</sup> / DELAY <sup>2</sup> INCOMING DETECT TIME	LOOP OFF- GUARD TIME (0 - 12 seconds)	LENGTH OF WINK SIGNAL (30 - 450 mS.)	LENGTH OF DELAY SIGNAL (0 - 4200 mS.)	WINK/ DELAY SIGNAL DETECT TIMEOUT (1 - 9 seconds)	OUTGOING GUARD TIME (1 - 9 seconds)	TANDEM RESTRICTION/ LCR CONTROL TIME (2 - 9 seconds)	
DEFAULT	1000 mS.	3 sec.	520 mS.	520 mS.	520mS <sup>1</sup> / 120mS <sup>2</sup>	2 sec.	180 mS.	300 mS.	7 sec.	3 sec.	12 sec.	
T												
R												
U												
N												
K												
G												
R												
O												
U												
P												
S												
8												

# JOB SPECIFICATION INSTRUCTIONS FOR MEMORY BLOCKS 4E-7 & 4E-8 - TLI PARAMETERS

ITEM NUMBER	CCU MODULE (1-3)	TLI CHANNEL (1 OR 2)	4E-7		4E-8				RECEIVER DIAL TYPE (DP, MF, DP/MF)
			INTERNAL (0-8)	EXTERNAL (0-8)	DTMF INTER DURATION (60-760)	SENDER DIAL TYPE (DP or MF)	RECEIVER DIAL TYPE (DP, MF, DP/MF)		
1			REC.	TRANS.	REC.	TRANS.	DTMF TIME DURATION (60-760) <td>SENDER DIAL TYPE (DP or MF) <td>RECEIVER DIAL TYPE (DP, MF, DP/MF) </td></td>	SENDER DIAL TYPE (DP or MF) <td>RECEIVER DIAL TYPE (DP, MF, DP/MF) </td>	RECEIVER DIAL TYPE (DP, MF, DP/MF)
2			0	0	0	0	70 msec.	DP	DP
3							110 msec.		
4									
5									
6									
7									
8									
9									
10									
11									
12									

## ITEM DESCRIPTION ENTRY

- 1 Tie Line trunk number. 1 ~ 40
- 2 CCU/Module number where the associated TLI card is located. 1 ~ 3
- 3 CCU/Slot number where the associated TLI card is located. 1 ~ 8
- 4 Channel (circuit) on the TLI card associated with the Tie Line. 1 ~ 2
- 5 dB pad value assigned to E&M receive circuit during internal Tie Line connections. 0 ~ 8
- 6 dB pad value assigned to E&M transmit circuit during internal Tie Line connections. 0 ~ 8
- 7 dB pad value assigned to E&M receive circuit during external tandem Tie Line connections. 0 ~ 8
- 8 dB pad value assigned to E&M transmit circuit during external tandem Tie Line connections. 0 ~ 8
- 9 Minimum time duration between DTMF digits when dialing. 40 ms. ~ 180 ms.
- 10 Time duration of Tie line DTMF digits. 60 ms. ~ 760 ms.
- 11 Selects rotary (DP) or pushbutton (MF) dialing. DP or MF
- 12 Selects rotary (DP), pushbutton (MF), or both DP/MF dialing. DP, MF, or DP/MF

# TLI INITIALIZED VALUES

ITEM NUMBER	CCU MODULE (1~3)	CCU SLOT (1~8)	TLI CHANNEL (1 OR 2)	4E-7						4E-8			
				INTERNAL (1~8)		EXTERNAL (1~8)		DTMF INTER DIGIT TIMER (40~180)	DTMF TIME DURATION (60~760)	SENDER DIAL TYPE (DP or MF)	RECEIVER DIAL TYPE (DP, MF, DP/MF)		
				REC.	TRANS.	REC.	TRANS.						
DEFAULT	-	-	-	0	0	0	0	78 msec.	110 msec.	DP	DP		

# JOB SPECIFICATION INSTRUCTIONS FOR MEMORY BLOCKS 4E-9 & 4E-10 - TLI PARAMETERS AND MEMORY BLOCKS 2B-10 & 2C-6 - UNIFORM DIALING

ITEM DESCRIPTION ENTRY

MEMORY BLOCK 4E-9	
TANDEM PORT	HARDWARE
	HUNT GROUP (1-8)

ASSIGNS A TANDEM HUNT GROUP TO A TANDEM PORT.

1 ~ 8

ASSIGNS HARDWARE AND SOFTWARE TANDEM PORTS. HARDWARE PORTS ARE ASSIGNED TO EXISTING ESI PORTS; SOFTWARE PORTS ARE ASSIGNED TO IMAGINARY PORTS.

HARDWARE OR SOFTWARE

MEMORY BLOCK 4E-10	
TRUNK GROUP	TANDEM HUNT GROUP (1-8)
1	
2	
3	

SELECTS A TANDEM PORT

100 ~ 899 OR 1000 ~ 8999

TANDEM HUNT GROUP ASSIGNED TO EACH TRUNK GROUP.

1 ~ 8

MEMORY BLOCK 2B-10
RECALL KEY OPERATION ON TIE LINES (INT/TIE) (DEFAULT INT)

ASSIGNS INTERNAL OR TIE LINE DIAL TONE WHEN THE RECALL KEY IS DEPRESSED.

INT OR TIE

MEMORY BLOCK 2C-6	
UNIFORM DIAL NUMBER (01 ~ 20)	TRUNK ACCESS CODE GROUP (2 ~ 8)

SELECTS A UNIFORM DIAL NUMBER.

01 ~ 20

SELECTS A TRUNK ACCESS CODE GROUP FOR THE UNIFORM DIAL NUMBER SELECTED.

2 ~ 8

**TANDEM PORT TO HUNT  
GROUP ASSIGNMENT (4E-9)**

TANDEM PORT	HARDWARE OR SOFTWARE	HUNT GROUP (1 ~ 8)

**TANDEM HUNT  
GROUP ASSIGNMENT (4E-10)**

TRUNK GROUP	TANDEM HUNT GROUP (1 ~ 8)
1	
2	
3	
4	
5	
6	
7	
8	

**TIE LINE OR EXTENSION DIAL  
TONE ASSIGNMENT (2B-10)**

RECALL KEY OPERATION ON TIE LINES (INT or TIE)	
---	--

**TRUNK ACCESS CODE GROUP  
TO UNIFORM DIAL NUMBER  
ASSIGNMENT (2C-6)**

UNIFORM DIAL NUMBER (01~20)	TRUNK ACCESS CODE GROUP (2~8)



## **CHAPTER 4**

### **STATION OPERATION**





## CHAPTER 4 STATION OPERATION

410	General	PAGE	430	Attendant Operation	PAGE
		400 - 1			
420	<b>Multiline Terminal Operation</b>				
420.1	CO/PBX (Outside) Calls, Trunk Queuing	400 - 2	430.1	CO/PBX/Tie (Outside) Calls using the CO Add On Module	400 - 103
420.2	Tie Lines & DID	400 - 8	430.2	CO Trunk Selection and Test	400 - 107
420.3	Extension (Internal) Calls	400 - 10	430.3	CO Trunk and MFR Circuit Busy Out/Restore	400 - 108
420.4	Handsfree Call	400 - 14	430.4	Originating Extension (Internal) Calls	400 - 109
420.5	Dual Path Call	400 - 19	430.5	Attendant Transfer	400 - 110
420.6	Transfer	400 - 21	430.6	DND Override	400 - 111
420.7	Conference	400 - 23	430.7	Originating Internal Zone Paging	400 - 112
420.8	Unsupervised Conference	400 - 25	430.8	Originating External Zone Paging	400 - 113
420.9	Internal Zone Paging	400 - 32	430.9	Message Waiting	400 - 114
420.10	External Zone Paging	400 - 34	430.10	Night Transfer	400 - 115
420.11	Consultation Hold (Broker's Call)	400 - 36	430.11	Attendant Camp On	400 - 117
420.12	Call Park	400 - 38	430.12	Attendant Off-Hook Ringing	400 - 118
420.13	Dial 0 For Attendant	400 - 41	430.13	Station Lockout	400 - 119
420.14	Call Pickup	400 - 43	430.14	Call Forward Set/Verify/Cancel	400 - 120
420.15	Night Call Pickup	400 - 44	430.15	Programming System Speed Dial	400 - 122
420.16	Callback Request Message	400 - 46	430.16	Clock/Calendar Setting	400 - 124
420.17	Camp On	400 - 47			
420.18	Tone Override	400 - 50			
420.19	Automatic Callback	400 - 51	440	<b>Single Line Telephone Operation</b>	
420.20	Account Code Entry	400 - 52	440.1	CO/PBX (Outside) Calls	400 - 127
420.21	Save and Repeat	400 - 54	440.2	Extension (Internal) Calls/Step Call	400 - 129
420.22	Do Not Disturb	400 - 55	440.3	MFR Circuit Selection and Test	400 - 130
420.23	Call Forward	400 - 56	440.4	Trunk Queuing	400 - 131
420.24	Programming Station Speed Dial and Feature Access Keys	400 - 57	440.5	Transfer	400 - 132
420.25	User Programming	400 - 61	440.6	Conference	400 - 133
420.26	Background Music	400 - 67	440.7	Unsupervised Conference	400 - 134
420.27	Calculation (Multiline Terminal with a Display)	400 - 68	440.8	Internal Zone Paging	400 - 135
420.28	Station Lockout	400 - 69	440.9	External Zone Paging	400 - 135
420.29	Voice Mail Call	400 - 74	440.10	Consultation Hold (Broker's Call)	400 - 136
420.30	Data Communications	400 - 76	440.11	Call Park	400 - 137
420.31	Modem Pooling	400 - 79	440.12	Dial 0 For Attendant	400 - 138
		400 - 95	440.13	Call Pickup	400 - 139
			440.14	Night Call Pickup	400 - 139
			440.15	Callback Request Message	400 - 140
			440.16	Camp-On	400 - 141
			440.17	Tone Override	400 - 142

## CHAPTER 4 STATION OPERATION

	PAGE		PAGE
440.18	400 - 143		
440.19	400 - 144		
440.20	400 - 145		
440.21	400 - 146		
440.22	400 - 147		
440.23	400 - 148		
Automatic Callback			
Account Code Entry			
Call Forward			
Programming Station Speed Dial			
Station Lockout			
Voice Mail Call			
		450	Executive Multiline Terminal Operation
		450.1	General
		450.2	Page Selection
		450.3	Programming Station Speed Dial
		450.4	Originating Calls
			400 - 149
			400 - 150
			400 - 151
			400 - 157

#### **410 GENERAL**

The Electra Mark II Station User's Operation Guide is divided into four sections. Each section is further sub-divided to provide a detailed step-by-step feature operation guide. The Operation Guide provides the LED and LCD status for each feature at each point of operation.

The four sections of Chapter 4 are:

- 420 Multiline Terminal Operation
- 430 Attendant Operation
- 440 Single Line Telephone Operation
- 450 Executive Multiline Terminal Operation

Section 420 includes all operations available to all Multiline Terminals.

Section 430 augments section 420; with only attendant operations included in this section.

Section 440 provides all operations available to single line telephones only.

Section 450 augments section 420 for users of the Executive Multiline Terminal; only the operations available to the Executive Multiline Terminals are included.

SAMPLE LED INDICATIONS

SAMPLE LCD INDICATIONS

**420 Multiline Terminal Operation**

**420.1 CO/PBX (Outside) Calls**

**1. Originating**

- a. Manual Dialing.
- Depress an idle CO/PBX line key.
  - Lift handset to receive dial tone.

CO/PBX									
--------	--	--	--	--	--	--	--	--	--

green LED lights.

			C	O			L	I	N	E		
	1	0	:	4	5		O	C	T	2	8	F
												R
												I

- Dial desired number and receive ring back tone.

				5	1	6	7	5	3	7	0	0
	1	0	:	4	5		O	C	T	2	8	F
												R
												I

- Converse with called party.

E	L	A	P	S	E				0	0	:	3	7
	1	0	:	4	5		O	C	T	2	8	F	R
													I

- b. Dial Access on Extension Line.

- Depress an idle extension line key.
- Lift handset to receive dial tone.

EXT									
-----	--	--	--	--	--	--	--	--	--

green LED lights.

			E	X	T		L	I	N	E		
	1	0	:	4	5		O	C	T	2	8	F
												R
												I

- Dial trunk access code (Default 9, 8, 70~75) and desired number. (Access code 9 is fixed.) Receive ring back tone.  
 NOTE: CO/PBX red LED lights if seized trunk is also a line key appearance.

				5	1	6	7	5	3	7	0	0
	1	0	:	4	5		O	C	T	2	8	F
												R
												I

- Converse with called party.

E	L	A	P	S	E				0	0	:	3	7
	1	0	:	4	5		O	C	T	2	8	F	R
													I

- c. Last CO/PBX Number Redial
- Depress an idle extension or CO/PBX line key.
  - Lift handset to receive dial tone.

CO/PBX									
--------	--	--	--	--	--	--	--	--	--

green LED lights.

			C	O			L	I	N	E		
	1	0	:	4	5		O	C	T	2	8	F
												R
												I

- Dial \* (If \* is assigned to be dialed on CO/PBX lines as a first digit, depress DSS key assigned for last number redial when using CO/PBX line keys.).

				5	1	6	7	5	3	7	0	0
	1	0	:	4	5		O	C	T	2	8	F
												R
												I

SAMPLE LED INDICATIONS

- Converse with called party.
- d. Station Speed Dialing
  - Depress an idle extension or CO/PBX line key.
  - Lift handset to receive dial tone.
  - Depress desired DSS key programmed for speed dial, or dial # followed by station speed dial buffer number (00~19).
  - Converse with called party.

**CO/PBX** green LED lights.

SAMPLE LCD INDICATIONS

E	L	A	P	S	E	D				0	0	:	3	7	
1	0	:	4	5		O	C	T		2	8		F	R	I

				C	O			L	I	N	E				
1	0	:	4	5		O	C	T		2	8		F	R	I

						5	1	6	7	5	3	7	0	0	0
1	0	:	4	5		O	C	T		2	8		F	R	I

E	L	A	P	S	E	D					0	0	:	2	7
1	0	:	4	5		O	C	T		2	8		F	R	I

				E	X	T		L	I	N	E				
1	0	:	4	5		O	C	T		2	8		F	R	I

													S	2	0
1	0	:	4	5		O	C	T		2	8		F	R	I

E	L	A	P	S	E	D					0	0	:	3	7
1	0	:	4	5		O	C	T		2	8		F	R	I

**NOTE:** If # is programmed to be dialed on CO/PBX lines as a first digit, depress DSS key assigned for speed dial, and dial # followed by station speed dial buffer number when calling on CO/PBX lines.

- e. System Speed Dialing
  - Depress an idle extension or CO/PBX line key.
  - Lift handset to receive dial tone.
  - Dial # followed by system speed dial buffer number (20 ~ 99).
  - NOTE:** CO/PBX red LED lights if seized trunk is also a line key appearance.
  - Converse with called party.

**EXT** green LED lights.

**NOTE:** If # is programmed to be dialed on CO/PBX lines as a first digit, depress DSS key assigned for speed dial, and dial # followed by speed dial buffer number when calling on CO/PBX lines.

SAMPLE LED INDICATIONS

- f. Prime Line
- Lift handset to receive dial tone.
  - Use any of the dialing methods described here.
- g. Consecutive Dialing
- Depress an idle extension or CO/PBX line key.
  - Lift handset to receive dial tone.
  - Use any combinations of manual dialing, station speed dialing and system speed dialing.
  - Converse with called party.

**EXT**

green LED lights.

SAMPLE LCD INDICATIONS

1	0	:	4	5		O	C	T		2	8		F	R	I		

1	0	:	4	5		O	C	T		2	8		F	R	I		

E	L	A	P	S	E	D				0	0	:	2	7			
1	0	:	4	5		O	C	T		2	8		F	R	I		

**NOTE:** An additional dialing step may be required in the following cases:

When a system speed dialing sequence follows a manual dialing sequence, DSS key programmed for speed dial access must be depressed prior to accessing the system speed dialing.

When a system speed dialing sequence follows a station or another system speed dialing sequence, DSS key programmed for speed dial access must be depressed prior to accessing the system speed dialing unless the last digit of number stored in the preceding speed dial buffer is \*.

When a station speed dialing sequence (using # followed by speed dial buffer number) follows a manual dialing sequence, it does not function.

SAMPLE LED INDICATIONS

SAMPLE LED INDICATIONS

When a station speed dialing sequence (using # followed by speed dial buffer number) follows a system or another station speed dialing sequence, it does not function unless the last digit of numbers stored in the preceding speed dial buffer is \*.

**2. Answering**

a. Manually Selecting Line

- Depress CO/PBX line key associated with flashing LED.

CO/PBX and ANS red LED's flash.

L	K	1	2					C	O	C	A	L	L	
1	0	:	4	5		O	C	T	2	8		F	R	I

- Use handset to talk .

CO/PBX green LED lights.  
ANS LED goes off.

E	L	A	P	S	E	D					0	0	:	0	3
1	0	:	4	5		O	C	T	2	8		F	R	I	

b. Answer Key

- Depress ANS key with flashing LED.

CO/PBX and ANS red LED's flash.

L	K	1	2					C	O	C	A	L	L	
1	0	:	4	5		O	C	T	2	8		F	R	I

- Use handset to respond.

CO/PBX green LED lights.  
ANS LED goes off.

E	L	A	P	S	E	D					0	0	:	0	3
1	0	:	4	5		O	C	T	2	8		F	R	I	

**NOTE:** Depression of ANS key with call in progress places original call on hold, with I-hold LED indication.

c. Prime Line or Ringing Line Preference

- Lift handset to respond.

EXT and ANS red LED's flash.

L	K	1	6			T	R	F	X			L	I	N	E
1	0	:	4	5		O	C	T	2	8		F	R	I	

When receiving a Transferred CO call, (or a DID call is received on the primary extension) the LCD will show the name assigned to the trunk group to which the transferred CO line (or DID line) belongs.

**NOTE:** System programming data must be entered for trunk group name assignment to be displayed.

SAMPLE LED INDICATIONS

**NOTE:** System data must be entered for incoming calls to be picked up on prime line.

**3. Placing a Call On Hold**

a. With No Incoming Call:

- Depress HOLD key once for non-exclusive hold.

OR

- Depress HOLD key twice for exclusive hold.

b. With Incoming Call:

- Depress ANS key for non-exclusive hold.

OR

- Depress HOLD key twice for exclusive hold.

- Then, depress ANS key.

**CO/PBX** green LED is lit steady.

E	L	A	P	S	E	D				0	0	:	2	3	
1	0	:	4	5	O	C	T			2	8		F	R	I

**CO/PBX** green LED winks intermittently.

1	0	:	4	5	O	C	T			2	8		F	R	I

**CO/PBX** green LED winks intermittently.

1	0	:	4	5	O	C	T			2	8		F	R	I

**CO/PBX** green LED is lit steady.

<b>CO/PBX</b>															
<b>EXT</b>	and	<b>ANS</b>	red LED's flash.												
E	L	A	P	S	E	D				0	3	:	4	6	
1	0	:	4	5	O	C	T			2	8		F	R	I

**CO/PBX** green LED winks intermittently.

<b>CO/PBX</b>															
<b>EXT</b>	green LED lights.														
<b>ANS</b>	LED goes off.														
	<b>S</b>	<b>T</b>	<b>E</b>	<b>V</b>	<b>E</b>					1	3		7		
1	0	:	4	5	O	C	T			2	8		F	R	I

**CO/PBX** green LED winks intermittently.

<b>CO/PBX</b>															
<b>EXT</b>	green LED lights.														
<b>ANS</b>	LED goes off.														
L	K	1	6		S	T	E	V	E				1	3	7
1	0	:	4	5	O	C	T			2	8		F	R	I

**EXT** green LED lights.

<b>EXT</b>	green LED lights.														
<b>ANS</b>	LED goes off.														
	<b>S</b>	<b>T</b>	<b>E</b>	<b>V</b>	<b>E</b>								1	3	7
1	0	:	4	5	O	C	T			2	8		F	R	I



SAMPLE LED INDICATIONS

Held **CO/PBX** green LED flutters.

**ANS** LED flashes.

**CO/PBX** green LED lights.

**ANS** LED goes off.

**EXT** LED winks intermittently.

				S	T	E	V	E			1	3	7		
1	0	:	4	5		O	C	T		2	8		F	R	I

E	L	A	P	S	E	D				0	3	:	5	2	
1	0	:	4	5		O	C	T		2	8		F	R	I

**CO/PBX** green LED is lit steady.

E	L	A	P	S	E	D				0	3	:	1	6	
1	0	:	4	5		O	C	T		2	8		F	R	I

**CO/PBX** green LED goes off.

1	0	:	4	5		O	C	T		2	8		F	R	I

**CO/PBX** green LED remains lit.

1	0	:	4	5		O	C	T		2	8		F	R	I

**NOTE:** The Multiline Terminal placing a call on hold will be recalled on the line key after a predetermined time lapse. Depress the line key with fluttering LED or the ANS key and lift handset to answer the hold recall.

4. Abandoning A Call

a. Using handset.

- Restore handset.

b. Using Recall key

- Depress RECALL key at the end of the call.
- CO/PBX call is released, but line is retained and new dial tone is heard.

**NOTE:** Depending on the CO/PBX exchange the Electra Mark II is connected to, when loop start trunks are used, depression of the Recall key might not release a call when on the receiving side of the call. When this happens, the user does not get new dial tone. When using LCR, the recall key may provide a hookflash, the user does not get new dial tone.

SAMPLE LED INDICATIONS

5. Trunk Queuing

a. To set a Trunk Queue: After attempting to seize a CO/PBX trunk or TIE line via dial access from an extension line and receiving busy tone. (If all of the trunks in that particular group are busy.)

- Dial Trunk Queue Access Code \*1, receive confirmation tone
- Restore handset.

**EXT** green LED is lit.

1	0	:	4	5	O	C	T	2	8
								F	R
								I	

b. Receiving Trunk Queue Recall: When a trunk within the Trunk Group to which the queue was set becomes idle the station which set the queue receives a recall tone after it becomes idle.

- Depress flashing ANS key or EXT line key, receive CO/PBX or TIE line dial tone.
- Dial desired number; receive ring back tone; wait for called party to respond.
- Converse.

**EXT** green LED flutters and **ANS** red LED flashes.

L	K	1	6	Q	U	E			
1	0	:	5	2	O	C	T	2	8
								F	R
								I	

**EXT** green LED lights.

				C	O	L	I	N	E
1	0	:	5	2	O	C	T	2	8
								F	R
								I	

					5	1	6	7	5	3	7	0	0	0
1	0	:	5	2	O	C	T	2	8	F	R	I		

E	L	A	P	S	E	D			0	0	:	3	7	
1	0	:	5	3	O	C	T	2	8	F	R	I		

SAMPLE LED INDICATIONS

SAMPLE LCD INDICATIONS

- c. Trunk Queue cancellation:
1. A Trunk Queue will be automatically cancelled if the recall to the extension is not answered within a pre-programmed time interval.
  2. A Trunk Queue will be cancelled by any attempt to access any CO/PBX or TIE line via dial access from any extension, by the station which set the Trunk Queue.

**NOTES:** Trunk Queuing cannot be accessed by a station that is assigned LCR. If this is attempted re-order tone will be heard.

Recall will not occur until the station that set the queue and it's primary extension are idle.

SAMPLE LED INDICATIONS

SAMPLE LCD INDICATIONS

420.2 Tie Lines & DID

1. Originating (for Tie Lines only)

a. Manual Dialing

- Depress an idle line key dedicated to a Tie line.
- Lift handset to receive dial tone.
- Dial desired number and receive ring back tone.
- Converse with called extension.

**TIE** green LED lights.

		T	I	E	L	I	N	E				
1	0	:	4	5	O	C	T	2	8	F	R	I

										6	1	2	3			
1	0	:	4	5	O	C	T	2	8					F	R	I

b. Dial Access On Extension Line

- Depress an idle extension line key and lift handset to receive dial tone.
- Dial trunk access code (Default: 8, 70~75) and desired number. Receive ring back tone.

**EXT** green LED lights.

E	L	A	P	S	E	D				0	0	:	0	2		
1	0	:	4	5	O	C	T	2	8					F	R	I

		E	X	T	L	I	N	E				
1	0	:	4	5	O	C	T	2	8	F	R	I

											6	1	2	3		
1	0	:	4	5	O	C	T	2	8					F	R	I

NOTE: TIE line red led lights if seized trunk is also a line key appearance.

E	L	A	P	S	E	D				0	0	:	0	2		
1	0	:	4	5	O	C	T	2	8					F	R	I

- Converse with called party.

NOTE: Last number redial, station speed dialing or system speed dialing can also be used to originate outside calls on Tie lines.

SAMPLE LED INDICATIONS

**2. Answering**

**a. Manually Selecting Line:**

- Depress primary extension line key with flashing LED.
- Lift handset to respond.

Primary **EXT** and **ANS** red LEDs are flashing.

Primary **EXT** green LED lights. **ANS** LED goes off.

L	K	1	6																	
1	0	:	4	5		O	C	T	2	8			T	I	E		L	I	N	E

E	L	A	P	S	E	D															
1	0	:	4	5		O	C	T	2	8							0	0	:	0	2

**b. Answer Key**

- Depress ANS key with flashing LED.
- Lift handset to respond.

Primary **EXT** and **ANS** red LEDs are flashing.

Primary **EXT** green LED lights. **ANS** LED goes off.

L	K	1	6																				
1	0	:	4	5		O	C	T	2	8							T	I	E	L	I	N	E

E	L	A	P	S	E	D																		
1	0	:	4	5		O	C	T	2	8										0	0	:	0	2

**NOTE:** Depression of the ANS key with a call in progress places the original call on hold, with I-hold LED indication.

SAMPLE LED INDICATIONS

**3. Abandoning**

a. Using Handset:

With call on Tie line in progress.

- Restore handset.

Primary **EXT** green LED lights steady.

E	L	A	P	S	E	D			0	3	:	1	0
1	0	:	4	5	O	C	T	2	8		F	R	I
1	0	:	4	5	O	C	T	2	8		F	R	I

Primary **EXT** LED goes off.

b. Using Recall Key:

With a Tie line call in progress on a line key (assigned to a Tie Line).

- Depress RECALL key when call is completed the connection is released, the Tie line is retained and new Tie Line dial tone is received.

Tie line **TIE** green LED lights steady.

E	L	A	P	S	E	D			0	3	:	1	0
1	0	:	4	5	O	C	T	2	8		F	R	I
1	0	:	4	5	O	C	T	2	8		F	R	I

Tie line **TIE** LED remains lit.

With a Tie Line call in progress on an extension line key.

- Depress RECALL key when call is completed the connection is released and new internal dial tone is received.

Primary **EXT** green LED lights steady.

E	L	A	P	S	E	D			0	3	:	1	0
1	0	:	4	5	O	C	T	2	8		F	R	I
1	0	:	4	5	O	C	T	2	8		F	R	I

Primary **EXT** LED goes off.

**4. Abandoning by Distant Party**

a. Connection On direct Tie line key:

With call on Tie line in progress.

- Other party abandons call; reorder tone is heard.

Tie line **TIE** green LED lights steady.

E	L	A	P	S	E	D			0	3	:	1	0
1	0	:	4	5	O	C	T	2	8		F	R	I
1	0	:	4	5	O	C	T	2	8		F	R	I

Tie line **TIE** LED goes off.

1	0	:	4	5	O	C	T	2	8		F	R	I

SAMPLE LED INDICATIONS

- b. Call On Extension line key.
  - With call on Tie line in progress:
    - Other party abandons call; reorder tone is heard.
    - Restore handset.

SAMPLE LCD INDICATIONS

ELAPSED			03	10
10:45	OCT	28	FRI	

10:45	OCT	28	FRI	

10:45	OCT	28	FRI	

**5. Hold, Transfer, Conference:**

Station operations for these features are the same as those for regular CO/PBX lines.

**NOTE:** Calls on Tie lines cannot be held unless the call is already established.

SAMPLE LED INDICATIONS

420.3 Extension (Internal) Calls

1. Originating

a. Manual Dialing

- Depress an idle extension line key.
- Lift handset to receive dial tone.

**EXT**

green LED lights.

- Dial extension number.
- Converse with called extension.

**NOTE:** When a called station is programmed for Voice, a caller can voice announce or dial 1 to change to tone signaling.

When a called station is programmed for tone, a caller must wait for the called station to answer.

b. Using DSS Key

- Depress an idle extension line key.
- Lift handset to receive dial tone.
- Depress DSS key programmed to call the desired extension.
- Converse with called extension.

**EXT**

green LED lights.

**DSS**

LED lights.

**NOTE:** Virtual extensions can also be assigned on DSS keys.

SAMPLE LCD INDICATIONS

		E	X	T	L	I	N	E	
1	0	:	4	5	O	C	T	2	8
								F	R
								I	

1	0	:	4	5	O	C	T	2	8
								F	R
								I	

1	0	:	4	5	O	C	T	2	8
								F	R
								I	

		E	X	T	L	I	N	E	
1	0	:	4	5	O	C	T	2	8
								F	R
								I	

1	0	:	4	5	O	C	T	2	8
								1	3
								7	

1	0	:	4	5	O	C	T	2	8
								F	R
								I	



SAMPLE LED INDICATIONS

SAMPLE LED INDICATIONS

**NOTE:** Extensions can be called by depressing a DSS key that has been programmed with the corresponding extension number.

The LED's (next to the DSS keys) serve as busy lampfield indicators for their corresponding DSS keys. This feature is available on ETE-16D-1 Multiline Terminals only.

Built-in BLF LED's on the Multiline Terminals are only red LED's.

For BLF LED flashing patterns, see Table 220-12 in Section 220 of this manual.

c. Prime Line.

When prime line assignment is for an extension line, the following sequence can be made:

- Lift handset to receive dial tone.
- Use any of the dialing methods described here.

d. Boss/Secretary ring (Multiline Terminals with DSS key only).

When a DSS key is programmed for Boss/Secretary ring followed by extension number, this DSS key can be used to place an internal call to Boss or Secretary.

**EXT** green LED lights.

		E	X	T	L	I	N	E		
1	0	:	4	5	O	C	T	2	8	F
										R
										I

SAMPLE LED INDICATIONS

- Depress an idle extension line key.
- Lift handset to receive dial tone.

**EXT**

green LED lights.

- Depress the DSS key programmed for Boss/Secretary ring.

**DSS**

LED lights.

Voice Page is heard at called Multiline Terminal

- Dial 1.
- Boss/Secretary ring tone rings at the called Multiline Terminal.
- Use handset to talk when answered.

**NOTE:** When depressing the DSS key, make sure that the associated LED is off.

e. Step Calling:

After calling an extension and receiving Busy Tone or Call Waiting Tone.

- Dial 2; Voice Page or, if Ring Back Tone is heard, wait for called party to lift handset.
- Converse.

**EXT**

green LED lit.

**2. Answering**

a. Manually Selecting Line.

- Depress extension line key associated with flashing LED.

**EXT**

and **ANS**

red LED's flash.

- Use handset to respond.

**EXT**

green LED lights.

**ANS**

LED goes off.

SAMPLE LCD INDICATIONS

		E	X	T	L	I	N	E				
1	0	:	4	5	O	C	T	2	8	F	R	I

										1	3	7
1	0	:	4	5	O	C	T	2	8	F	R	I

B	U	S	Y							1	1	1
1	0	:	4	5	O	C	T	2	8	F	R	I

										1	1	2
1	0	:	4	5	O	C	T	2	8	F	R	I

					L	O	U			1	1	2
1	0	:	4	5	O	C	T	2	8	F	R	I

L	K	1	6	S	T	E	V	E		1	3	7
1	0	:	4	5	O	C	T	2	8	F	R	I

					S	T	E	V	E		1	3	7
1	0	:	4	5	O	C	T	2	8	F	R	I	

SAMPLE LED INDICATIONS

- b. Answer Key
- Depress ANS key.

**EXT** and **ANS** red LED's flash.

LK	1	6	S	T	E	V	E			1	3	7
1	0	:	4	5	O	C	T	2	8	F	R	I

**EXT** green LED lights.

			S	T	E	V	E			1	3	7
1	0	:	4	5	O	C	T	2	8	F	R	I

- Use handset to respond.

**ANS** LED goes off.

**NOTE:** Depress of ANS key with call in progress places original call on hold, with I-hold LED indication.

- c. Prime Line or Ringing Line Preference
- Lift handset to respond.

**NOTE:** System data is required for incoming calls to be picked up by prime line.

**3. Placing a Call On Hold**

- a. With No Incoming Call

**EXT** green LED is lit steady.

			S	T	E	V	E			1	3	7
1	0	:	4	5	O	C	T	2	8	F	R	I

- Depress HOLD key once for non-exclusive hold.

**EXT** green LED winks intermittently.

1	0	:	4	5	O	C	T	2	8	F	R	I

OR

- Depress HOLD key twice for exclusive hold.

**EXT** green LED winks intermittently.

1	0	:	4	5	O	C	T	2	8	F	R	I

SAMPLE LED INDICATIONS

**EXT** green LED is lit steady.  
**CO/PBX** and **ANS** red LED's flash.

				S	T	E	V	E	
1	0	:	4	5	O	C	T	2	8
								F	R
									I

**EXT** green LED winks intermittently.  
**CO/PBX** green LED lights.  
**ANS** LED goes off.

				E	L	A	P	S	E
1	0	:	4	5	O	C	T	2	8
								F	R
									I

**EXT** green LED winks intermittently.  
**CO/PBX** green LED lights.  
**ANS** LED goes off.

				L	K	1	2		
1	0	:	4	5	O	C	T	2	8
								F	R
									I

- b. With Incoming Call
    - Depress ANS key for non-exclusive hold.
- OR
- Depress HOLD key twice for exclusive hold.
  - Then, depress ANS key.

**NOTE:** Any internal call placed on hold is not automatically released even if the held party abandons the call during the hold condition. Both stations must be off-hook to place the call on hold.

Regarding held recalls, see item 3, Section 420.1 of this chapter.

**4. Abandoning a Call**

- Restore handset.
- OR
- Depress RECALL key to place another call.

**EXT** green LED is lit steady.

				S	T	E	V	E	
1	0	:	4	5	O	C	T	2	8
								F	R
									I

**EXT** green LED goes off.

1	0	:	4	5	O	C	T	2	8
								F	R
									I

**EXT** green LED remains lit.

				E	X	T		L	I
1	0	:	4	5	O	C	T	2	8
								F	R
									I

SAMPLE LED INDICATIONS

**420.4 Handsfree Call**

Multiline Terminals equipped with HFU-E units provides full both-way handsfree operation.

**1. Originating**

- Depress an extension line key or a CO/PBX line key.
- Depress SPKR key and receive dial tone.
- Dial desired number or depress DSS key programmed for Station Speed Dial.
- Converse with party when answered.

**NOTE:** Make sure that MIC LED is lit.

Any methods described in Section 420.1 and 420.2 can be used for full both-way handsfree operation.

When a call is in progress using handsfree operation, the Multiline Terminal does not receive Boss/Secretary Alert and Ring tone (Internal Ring Tone, CO/PBX Ring tone, or Recall Tone).

**2. Answering**

- Depress the line key receiving an incoming call or a recall, or depress ANS key.

SAMPLE LCD INDICATIONS

			CO		LINE		
1	0	:	4	5	OCT	2	8
						FR	I

					5	1	6	7	5	3	7	0	0	0
1	0	:	4	5	OCT	2	8	FR	I					

ELAP	S	E	D												0	0	:	3	7	
1	0	:	4	5	OCT	2	8	FR	I											

LK	1	6	S	T	E	V	E													
1	0	:	4	5	OCT	2	8	FR	I											

**SPKR** LED lights.

**CO/PBX** green LED lights.

**EXT** and **ANS** red LED's flash.

**SPKR** LED is lit.

SAMPLE LED INDICATIONS

**EXT** green LED lights.  
**SPKR** LED lights.  
**ANS** LED goes off

1	0	:	4	5		S	T	E	V	E			1	3	7		
								O	C	T			2	8			
															F	R	I

E	L	A	P	S	E	D							0	5	:	4	3		
1	0	:	4	5			O	C	T				2	8			F	R	I

**NOTE:** Make sure that MIC LED is lit.

Depression of ANS key with call in progress places original call on hold, with I-hold indication.

**3. Placing a Call On Hold**

See Section 420.1, item 3. and 420.2, item 3. of this chapter.

**4. Abandoning a Call**

a. Using SPKR key.

**CO/PBX** green LED is lit steady.  
**SPKR** LED is lit steady.

E	L	A	P	S	E	D							0	5	:	4	3		
1	0	:	4	5			O	C	T				2	8			F	R	I

• Depress SPKR key.

**CO/PBX** and **SPKR** LED's go off.

1	0	:	4	5			O	C	T				2	8			F	R	I

b. Using Recall key.

- Depress RECALL key at the end of the call.
- The call is released and new dial tone is heard.

E	L	A	P	S	E	D							0	5	:	4	3		
1	0	:	4	5			O	C	T				2	8			F	R	I

1	0	:	4	5			O	C	T				2	8			F	R	I

**NOTE:** When LCR is used, the recall key may provide a hookflash, the user does not get new dial tone.

SAMPLE LED INDICATIONS

420.5 Dual Path Call

With call in progress on a line key other than primary extension line key, using handset

- A Multiline Terminal equipped with a DPA-E unit receives an incoming extension call on primary extension line and voice page alert tone.
- Respond with handsfree answer back.

**NOTE 1:** Calling party originates a dual path call as a regular extension call.

**NOTE 2:** For Multiline Terminals to receive dual path call, the following conditions are required:

- Available to ETE-6D-1, ETE-16D-1 and ETE-16K-1 Multiline Terminals equipped with DPA-E units.
- Multiline Terminals with DPA-E units must be supported by ESI-EB ETU(s).
- Dual path assignment must be programmed by system data.
- Multiline Terminals with dual path should be programmed for voice page, not ring assignment.
- Multiline Terminals with dual path should have a call in progress using the handset, on a line other than its primary extension line.

SAMPLE LCD INDICATIONS

E	L	A	P	S	E	D	:	0	5	:	4	3
1	0	:	4	5	O	C	T	2	8	F	R	I

**CO/PBX** green LED is lit steady.

Primary **EXT** red LED flashes.

**ANS** LED flashes

- Multiline Terminals with dual path should not be in DND, OFF-LINE or LOCKOUT mode.

**NOTE 3:** Going Off-Hook and seizing a line key while receiving voice page on primary path makes the voice page call shift to secondary path.

**NOTE 4:** Depressing the SPKR key and a line key while receiving voice page, call shifts to ring mode. (Calling party hears ring back tone, but called Multiline Terminal does not receive ring tone).

This ring call remains the same, even when the called Multiline Terminal resumes the conversation through the handset.



SAMPLE LED INDICATIONS

420.6 Transfer

1. Using Transfer Key

With call in progress:

- Depress TRF key; receive second dial tone.
- Dial extension number.
- When ring back tone is heard, depress TRF key or restore handset. (Transfer is completed when party answers).

OR

- When call waiting tone is heard, restore handset or depress TRF key (Original call is camped-on to busy extension).

**NOTE:** Unanswered transferred calls will recall to the primary extension of the user who initiated the transfer after the recall time interval has elapsed.

**CO/PBX** green LED is lit steady.

**ANS** LED lights.

**CO/PBX** red LED lights.

**ANS** LED goes off.

**CO/PBX** red LED lights.

**ANS** LED goes off.

SAMPLE LCD INDICATIONS

E	L	A	P	S	E	D			0	5	:	4	3	
1	0	:	4	5		O	C	T	2	8		F	R	I

1	0	:	4	5		O	C	T	2	8		F	R	I

												1	3	7
1	0	:	4	5		O	C	T	2	8		F	R	I

1	0	:	4	5		O	C	T	2	8		F	R	I

C	A	L	L		W	A	I	T	I	N	G		1	3	7
1	0	:	4	5		O	C	T	2	8		F	R	I	

C	A	M	P		O	N							1	3	7
1	0	:	4	5		O	C	T	2	8		F	R	I	

SAMPLE LED INDICATIONS

2. Using DSS Key

With call in progress:

- Depress DSS key programmed to call the desired extension number.
- When ring back is heard or voice announcement is made, restore handset. (Transfer is completed when party answers).

**CO/PBX** green LED is lit steady.

**DSS** and **ANS** LED's light.

**CO/PBX** red LED lights.  
**ANS** LED goes off.

OR

- When call waiting tone is heard, restore handset or depress TRF key. (Original call is camped-on to busy extension).

**CO/PBX** red LED lights.  
**ANS** LED goes off.

SAMPLE LCD INDICATIONS

E	L	A	P	S	E	D			0	4	:	1	7	
1	0	:	4	5		O	C	T	2	8		F	R	I

													1	3	7
1	0	:	4	5		O	C	T	2	8		F	R	I	

1	0	:	4	5		O	C	T	2	8		F	R	I	

C	A	L	L	W	A	I	T	I	N	G		1	3	7
1	0	:	4	5		O	C	T	2	8		F	R	I

C	A	M	P	O	N				→			1	3	7
1	0	:	4	5		O	C	T	2	8		F	R	I

#### 420.7 Conference

Possible conferences are as follows:

- 4 stations - No CO/PBX lines
- 3 stations - No CO/PBX lines
- 3 stations - 1 CO/PBX line
- 2 stations - 1 CO/PBX lines
- 2 stations - 2 CO/PBX lines
- 1 station - 2 CO/PBX lines

**NOTE 1:** When all conferences circuits are busy, CNF LED will light on all Multiline Terminals. No additional conferences can be made at this time.

**NOTE 2:** With four party conference call in progress, depression of CNF key is ignored and error tone burst is heard.

**NOTE 3:** Conference calls can be transferred using the following operation:

With three party conference in progress:

- Depress TRF key; CNF LED flashes.
- Dial desired extension number and wait for called party to answer.
- Converse with called party, and depress CNF key to establish four party conference; CNF LED steadily lights.

SAMPLE LED INDICATIONS

- Restore handset to drop from the conference.

**NOTE 5:** Four party conference calls cannot be transferred by any means.

**1. Three Party Conference**

a. Using One Line Key:

EXT
-----

green LED is lit steady.

CNF
-----

LED flashes

ANS
-----

LED lights.

E	L	A	P	S	E	D				0	2	:	3	5	
1	0	:	4	5		O	C	T		2	8		F	R	I

1	0	:	4	5		O	C	T		2	8		F	R	I

- Originate second call and wait for called party to answer.

1	0	:	4	5		O	C	T		2	8		1	3	7
1	0	:	4	5		O	C	T		2	8		F	R	I

- Depress CNF key and establish a 3 party conference.

CNF
-----

LED lights.

ANS
-----

LED goes off.

						S	T	E	V	E						1	3	8
1	0	:	4	5		O	C	T		2	8		F	R	I			

						C	O	N	F	E	R	E	N	C	E	0	2	:	5	0
1	0	:	4	5		O	C	T		2	8		F	R	I					

b. Using Two Line Keys:

EXT
-----

green LED is lit steady.

CNF
-----

LED flashes

ANS
-----

LED lights.

1	0	:	4	5		O	C	T		2	8		1	3	7					
1	0	:	4	5		O	C	T		2	8		F	R	I					

- With first call in progress, depress CNF key.

1	0	:	4	5		O	C	T		2	8		F	R	I					

- Depress another line key and originate second call, then wait for called party to answer.

Another 

EXT
-----

 green LED lights.

						E	X	T												
1	0	:	4	5		O	C	T		2	8		F	R	I					



**SAMPLE LED INDICATIONS**

- Depress CNF key and depress another line key.

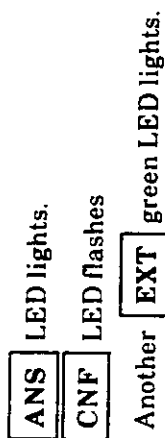

- Originate another call and wait for called party to answer.

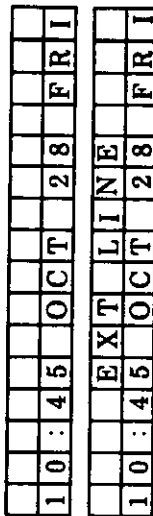

- Depress CNF key and establish a 4 party conference.

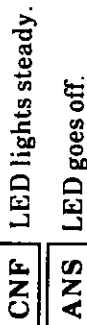
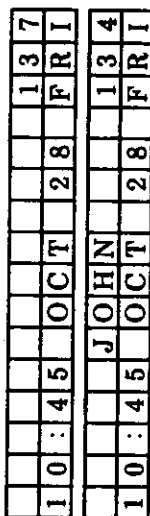

- b.2 With 3 party conference in progress using two line keys.

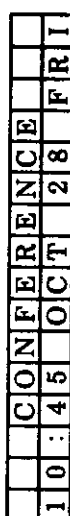
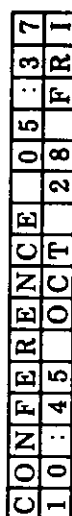
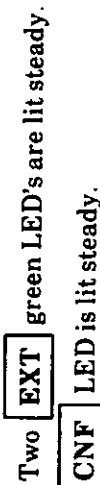

- Depress CNF key to receive second dial tone.

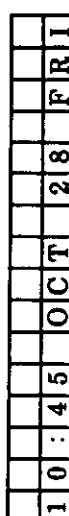
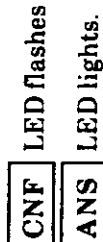

- Originate another call and wait for called party to answer.

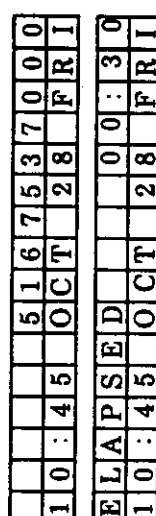

SAMPLE LED INDICATIONS

SAMPLE LCD INDICATIONS

Depress CNF key and establish a 4 party conference.

**CNF** LED lights steady.  
**ANS** LED goes off.

C	O	N	F	E	R	E	N	C	E	0	0	:	3	5
1	0	:	4	5	O	C	T	2	8	F	R	I		

c. Using Three Line Keys:

- With a 3 party conference in progress using two line keys.

Two **CO/PBX** green LED's are lit steady.  
**CNF** LED is lit steady.

C	O	N	F	E	R	E	N	C	E	0	3	:	2	5
1	0	:	4	5	O	C	T	2	8	F	R	I		

- Depress CNF key.

**CNF** LED flashes  
**ANS** LED lights.

1	0	:	4	5	O	C	T	2	8	F	R	I		

- Depress another line key and originate another call. Wait for called party to answer.

Another **EXT** green LED lights.

					E	X	T	L	I	N	E			
1	0	:	4	5	O	C	T	2	8	F	R	I		
												1	3	7
1	0	:	4	5	O	C	T	2	8	F	R	I		

					J	O	H	N				1	3	4
1	0	:	4	5	O	C	T	2	8	F	R	I		

- Depress CNF key and establish a 4 party conference.

**CNF** LED lights steady.  
**ANS** LED goes off.

C	O	N	F	E	R	E	N	C	E	0	3	:	4	0
1	0	:	4	5	O	C	T	2	8	F	R	I		

**3. Placing a Conference Call on Hold**

- With conference call in progress:

Two **CO/PBX** green LED's are lit steady.  
**CNF** LED is lit steady.

C	O	N	F	E	R	E	N	C	E	0	6	:	2	7
1	0	:	4	5	O	C	T	2	8	F	R	I		

SAMPLE LED INDICATIONS

- Depress HOLD key and hang up.

LED's associated with the line keys involved show I-Hold (Exclusive hold) indication.

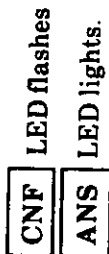

**NOTE:** When a conference call using multiple line keys is placed on hold, it splits into individually exclusive held line key. If any line key contains more than one party, only this case, a conference circuit is reserved to reenter the conference and the parties on the line key can still talk to each other. Other than this case, the conference circuit is released.

**4. Abandoning a Conference Call**

- Dropping from Conference (more than one internal station).

- With conference call in progress.

- Restore handset.

If another internal station was in the conference, the station will continue to converse normally.

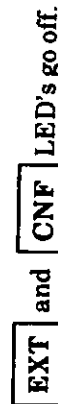
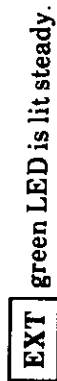

SAMPLE LCD INDICATIONS

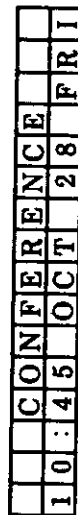
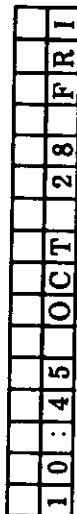



SAMPLE LED INDICATIONS

b. Abandoning

● With conference call in progress  
 ● Restore handset

**EXT** and **CO/PBX**  
**CNF**

LED's are lit steady.  
 LED is lit steady.

**EXT** and **CNF**

LED's go off.

SAMPLE LCD INDICATIONS

C	O	N	F	E	R	E	N	C	E	0	6	:	2	7
1	0	:	4	5	O	C	T	2	8	F	R	I		

1	0	:	4	5	O	C	T	2	8	F	R	I		

SAMPLE LED INDICATIONS

420.8 Unsupervised Conference

1. To Establish

With a three party conference including two CO/PBX parties in progress using an extension line key:

- Depress HOLD key; Two CO/PBX parties can still talk to each other.
- Hang up.

EXT	green LED is lit steady.
CNF	LED is lit steady.

C	O	N	F	R	E	R	E	N	C	E	0	6	:	2	7
1	0	:	4	5	O	C	T	2	8	F	R	I			

EXT	green LED winks intermittently.
-----	---------------------------------

1	0	:	4	5	O	C	T	2	8	F	R	I			

CNF	LED remains lit steady.
-----	-------------------------

2. To Reenter the Conference

- Depress the held extension line key.

EXT	green LED winks intermittently.
CNF	LED remains lit steady.

1	0	:	4	5	O	C	T	2	8	F	R	I			

- Lift handset to reenter the conference.

EXT	green LED lights.
-----	-------------------

C	O	N	F	R	E	R	E	N	C	E	0	3	:	5	2
1	0	:	4	5	O	C	T	2	8	F	R	I			

3. To Answer Conference Recall

After predetermined time since an unsupervised conference is established.

- The Multiline Terminal is recalled on the extension line key. Depress the line key or ANS key.

EXT	green LED flutters.
ANS	LED flashes
CNF	LED is lit steady.

L	K	1	6	R	E	C	A	L							
1	0	:	4	5	O	C	T	2	8	F	R	I			

SAMPLE LED INDICATIONS

- Lift handset or depress SPKR key to answer the conference recall.

**4. Abandoning a Conference**

After reentering the conference or answering the conference recall:

- Restore handset.

**EXT** green LED lights.  
**ANS** LED goes off.

**EXT** green LED is lit steady.  
**CNF** LED is lit steady.

**EXT** and **CNF** LED's go off.

SAMPLE LCD INDICATIONS

C	O	N	F	E	R	E	N	C	E	0	6	:	2	8
1	0	:	4	5	O	C	T	2	8	F	R	I		

C	O	N	F	E	R	E	N	C	E	0	7	:	1	3
1	0	:	4	5	O	C	T	2	8	F	R	I		

1	0	:	4	5	O	C	T	2	8	F	R	I		

SAMPLE LED INDICATIONS

420.9 Internal Zone Paging

1. To Originate:

- Depress an idle extension line key.
- Lift handset.
- Dial access code.

EXT

green LED lights.

Default values are as follows: (Last digit of each access code is fixed).

- 550 - All Call
- 551 - Zone 1
- 552 - Zone 2
- 553 - Zone 3
- 554 - All Zones

OR

Depress DSS key programmed for one of these access codes.

**NOTE:** Zone assignment is required for internal zone paging. In addition, another system data entry is required for internal all call.

- Use handset to page.

				E	X	T	L	I	N	E				
1	0	:	4	5	O	C	T	2	8	F	R	I		

1	0	:	4	5	O	C	T	2	8	F	R	I	5	5
													0	

SAMPLE LED INDICATIONS

**2. To Answer (Meet-me):**

**NOTE:** To use meet-me answer feature, a station must be in the same zone being paged.

- Depress an idle extension line key.
- Lift handset.
- Dial access code.

(Default value is 556. Last digit of the access code is fixed).

OR

- Depress DSS key programmed for this access code.
- Converse with paging party on handset.

SAMPLE LCD INDICATIONS

			E	X	T	L	I	N	E		
1	0	:	4	5	O	C	T	2	8	F	R

										5	5	6
1	0	:	4	5	O	C	T	2	8	F	R	I

					J	I	M	M	Y		1	3	2
1	0	:	4	5	O	C	T	2	8	F	R	I	

**SAMPLE LED INDICATIONS**

**420.10 External Zone Paging**

**1. To Originate:**

- Depress an idle extension line key.
- Lift handset.
- Dial access code.

**EXT**

green LED lights.

				E	X	T	L	I	N	E
1	0	:	4	5	O	C	T	2	8	F
										R
										I

Default values are as follows: (Last digit of each access code is fixed).

- 561 - Zone 1
- 562 - Zone 2
- 563 - Zone 3
- 564 - All Zones

1	0	:	4	5	O	C	T	2	8	F
										R
										I

OR

- Depress DSS key programmed for one of these access codes.
- Use handset to page.

**2. To Answer (Meet-me):**

- Depress an idle extension line key.
- Lift handset.

**EXT**

green LED lights.

				E	X	T	L	I	N	E
1	0	:	4	5	O	C	T	2	8	F
										R
										I

- Dial access code (Default value is 566. Last digit of the access code is fixed).

1	0	:	4	5	O	C	T	2	8	F
										R
										I

OR

SAMPLE LED INDICATIONS

- Depress DSS key programmed for this access code.
- Converse with paging party on handset.

SAMPLE LCD INDICATIONS

			J	I	M	M	Y			1	3	2
1	0	:	4	5		O	C	T		2	8	
						F	R	I				

SAMPLE LED INDICATIONS

420.11 Consultation Hold (Broker's Call)

The status of consultation hold comes about during the process of transfer, conference or broker's call. ANS LED steadily lights on any Multiline Terminal having consultation hold.

When a station having consultation hold goes on-hook, the station will be immediately recalled.

1. Transfer or Conference

With call in progress:

**EXT** green LED is lit steady.

- Depress TRF or CNF key; first party goes on consultation hold - receive second dial tone.

**CNF** LED flashes  
**ANS** LED lights.

- Dial a station number.

- Consult with second party when answered.

- Depress RECALL key to disconnect second party and ANS key to return to first party.

**CNF** and **ANS** LED's go off.

OR

- Depress TRF key or hang up to complete transfer, or depress CNF key to establish a conference.

**CNF** LED lights steady.  
**ANS** LED goes off.

SAMPLE LCD INDICATIONS

E	L	A	P	S	E	D				0	3	:	1	8	
1	0	:	4	5		O	C	T		2	8		F	R	I

1	0	:	4	5		O	C	T		2	8		F	R	I

													1	3	0
1	0	:	4	5		O	C	T		2	8		F	R	I

													1	3	0
1	0	:	4	5		O	C	T		2	8		F	R	I

E	L	A	P	S	E	D				0	3	:	4	8	
1	0	:	4	5		O	C	T		2	8		F	R	I

C	O	N	F	E	R	E	N	C	E		0	3	:	5	0
1	0	:	4	5		O	C	T		2	8		F	R	I



SAMPLE LED INDICATIONS

**2. Broker's Call**

**a. Originating:**

With call in progress:

**EXT**

green LED is lit steady.

- Depress TRF key; first party goes on consultation hold.

**ANS** LED lights.

- Receive second dial tone.
- Dial a station number.

- Consult with second party when answered.

- Depress ANS key to place second party on consultation hold and return to first party.

**b. Answering:**

With call in progress:

**EXT**

green LED is lit steady.

- The Multiline Terminal receives camp-on or tone override, then depress ANS key to answer the camped on call or tone overridden call.

**ANS** LED flashes

**ANS** LED lights steady.

(Depression of ANS key places first call on consultation hold.)

SAMPLE LCD INDICATIONS

E	L	A	P	S	E	D				0	3	:	1	8	
1	0	:	4	5	O	C	T			2	8		F	R	I

1	0	:	4	5	O	C	T			2	8		F	R	I

													1	3	0
1	0	:	4	5	O	C	T			2	8		F	R	I

1		:	4	5	O	C	T			2	8		F	R	I

E	L	A	P	S	E	D				0	3	:	4	8	
1	0	:	4	5	O	C	T			2	8		F	R	I

					S	T	E	V	E				1	3	7
1	0	:	4	5	O	C	T			2	8		F	R	I

C	A	M	P		O	N		E	X	T			1	3	1
1	0	:	4	5	O	C	T			2	8		F	R	I

					J	O	H	N					1	3	1
1	0	:	4	5	O	C	T			2	8		F	R	I

SAMPLE LED INDICATIONS

- Depress ANS key again to place second party on consultation hold and return to first party.

**NOTE:** In the preceding cases (a. and b.), successive depression of the ANS key alternates the connection between the first and second parties.

SAMPLE LCD INDICATIONS

				S	T	E	V	E			1	3	7
1	0	:	4	5	O	C	T	2	8		F	R	I

SAMPLE LED INDICATIONS

SAMPLE LCD INDICATIONS

420.12 Call Park

1. To Park a Call:

With call in progress

- Depress TRF key, receive feature dial tone (call is placed on Consultation Hold).
- Dial Call Park Access Code (Default 4\*) or depress DSS key programmed for this access code.
- Dial Call Park Location Number (0~9), receive confirmation tone.

OR

If the Call Park Location Number dialed is Busy (Busy Tone Received):

- Use step calling to advance to an idle call park location by consecutively dialing one digit until you receive confirmation tone.
- Restore handset.

CO/PBX/TIE or EXT green LED lit.

E	L	A	P	S	E	D				0	1	:	2	9	
1	0	:	4	5		O	C	T		2	8		F	R	I

CO/PBX/TIE or EXT green LED flashing  
 (1-hold). ANS red LED lit.

1	0	:	4	5		O	C	T		2	8		F	R	I

		P	A	R	K	N	B	R		?					
1	0	:	4	5		O	C	T		2	8		F	R	I

CO/PBX/TIE red LED lit or  
 EXT LED goes out. ANS LED goes out.

				P	A	R	K		0				S	E	T
1	0	:	4	5		O	C	T		2	8		F	R	I

CO/PBX/TIE or EXT green LED flashing.  
 ANS red LED lit.

B	U	S	Y		P	A	R	K		0					
1	0	:	4	5		O	C	T		2	8		F	R	I

CO/PBX/TIE red LED lit or  
 EXT LED goes out. ANS LED goes out.

					P	A	R	K		2			S	E	T
1	0	:	4	5		O	C	T		2	8		F	R	I

EXT LED goes out.

1	0	:	4	5		O	C	T		2	8		F	R	I

## 2. To Park a conference Call

- NOTES:** 1. Conference calls on more than one Line Key cannot be parked.  
2. A four (4) party conference cannot be parked.

### With conference call in progress:

- Depress TRF key and receive feature dial tone.
- Dial access code (Default: 4\*) or depress DSS key programmed for this access code.
- Dial Call Park location number (0~9), receive confirmation tone.
- Restore handset.

### 3. Retrieving a Call from Park:

- Seize an Extension line and lift handset, receive dial tone.
- Dial Call Park Access Code (Default 4\*).
- Dial Call Park Location number (0~9) of the call to be retrieved; converse.

### 4. Recall:

Any call left in Call Park for longer than a programmed interval will recall on the primary extension of the station which parked the call. This recall can be picked up by other stations in the system via Directed Call Pickup. (6#xxx)

**NOTE:** A Station that placed a conference call on exclusive hold or parked a conference call cannot retrieve another parked call or answer the recall for another unanswered parked conference call.

## SAMPLE LED INDICATIONS

**EXT**

green LED is lit steady.

**CNF**

LED is lit steady.

**CNF**

LED flashes.

**ANS**

LED lights.

**CNF**

LED lights.

**ANS**

LED goes out.

**EXT**

LED goes out.

**EXT**

green LED lit.

**EXT**

green LED and

**ANS**

red LED flashing.

## SAMPLE LCD INDICATIONS

C	O	N	F	E	R	E	N	C	E	0	1	:	2	9
1	0	:	4	5	O	C	T	2	8	F	R	I		

1	0	:	4	5	O	C	T	2	8	F	R	I		

			P	A	R	K	N	B	R	?				
1	0	:	4	8	O	C	T	2	8	F	R	I		

					P	A	R	K	2	S	E	T		
1	0	:	4	5	O	C	T	2	8	F	R	I		

1	0	:	4	5	O	C	T	2	8	F	R	I		

			E	X	T	L	I	N	E					
1	0	:	4	8	O	C	T	2	8	F	R	I		

			P	A	R	K	N	B	R	?				
1	0	:	4	8	O	C	T	2	8	F	R	I		

E	L	A	P	S	E	D				0	5	:	2	6
1	0	:	4	8	O	C	T	2	8	F	R	I		

L	K	I	6		P	A	R	K	0	R	E	C	A	L	L
1	0	:	4	9	O	C	T	2	8	F	R	I			

SAMPLE LED INDICATIONS

**420.13 Dial 0 For Attendant**

- Depress an idle extension line key.
- Lift handset.
  
- Dial 0 to call the associated attendant.
  
- Converse with the attendant.

**EXT** green LED lights.

SAMPLE LCD INDICATIONS

			E	X	T	L	I	N	E
1	0	:	4	5	O	C	T	2	8
								F	R
								I	

1	0	:	4	5	O	C	T	2	8
								F	R
								I	

1	0	:	4	5	O	C	T	2	8
								F	R
								I	

**NOTE:** When the associated attendant is busy, calls to the attendant can be routed to another attendant depending upon system programming. If the associated attendant is call forwarded to another station, calls to the attendant will be automatically forwarded to the station.

SAMPLE LED INDICATIONS

**420.14 Call Pickup**

**1. Call Pickup - Directed**

Station A is receiving an incoming call:

- Depress an idle extension line key of Multiline Terminal B.
- Lift handset of Multiline Terminal B.
- Dial access code (Default: 6#) or depress DSS key programmed for this access code.
- Dial the extension number of Station A.
- Use handset to talk to party who was calling Station A.

**EXT**

green LED lights.

				E	X	T	L	I	N	E
1	0	:	4	5	O	C	T	2	8	F
										R
										I

				E	X	T	N	U	M	B
1	0	:	4	5	O	C	T	2	8	F
										R
										I

				S	T	E	V	E		
1	0	:	4	5	O	C	T	2	8	F
										R
										I

Incoming calls to be picked up are as follows:

CO/PBX calls, extension calls, transferred calls, hold recalls, transfer recalls, and voice paged calls.

SAMPLE LED INDICATIONS

**2. Call Pickup - Group**

A station is receiving an incoming call:

- Depress an idle extension line key of a Multiline Terminal within the call pickup group.
- Lift handset.
- Dial the access code (Default: 6\*) or depress DSS key programmed for this access code.
- Use handset to talk to party who was calling the station.

**EXT**

green LED lights.

SAMPLE LCD INDICATIONS

		E	X	T	L	I	N	E	
1	0	:	4	5	O	C	T	2	8
								F	R
									I

		E	L	A	P	S	E	D	
1	0	:	4	5	O	C	T	2	8
								0	0
								:	0
									5
								F	R
									I

Incoming calls to be picked up are CO/PBX calls, extension calls and transferred calls.

A station should be assigned to a call pickup group.

SAMPLE LED INDICATIONS

**420.15 Night Call Pickup**

With incoming CO/PBX call present during night mode.

- Depress an idle extension line key.
- Lift handset.
- Dial access code (Default 60) or depress DSS key programmed for this access code.
- Use handset to talk to calling party.

**EXT**

green LED lights.

		E	X	T	L	I	N	E	
1	0	:	4	5	O	C	T	2	8
								F	R
									I

		E	L	A	P	S	E	D	
1	0	:	4	5	O	C	T	2	8
								0	0
									5
								F	R
									I

Incoming calls to be picked up are CO/PBX calls only.



SAMPLE LED INDICATIONS

**420.16 Callback Request Message**

**1. To Set:**

Upon receiving call waiting tone, busy tone or no answer when placing an extension call:

- Dial access code (Default: #) or depress DSS key programmed for this access code.
- Receive confirmation tone and hang up.

**NOTE:** Callback requests (3 maximum) can only be set at a Multiline Terminal with LCD. They cannot be set at SLT's or Multiline Terminals without LCD.

**2. To Cancel:**

**a. From originating Multiline Terminal:**

- Depress primary extension line key.
- Lift handset to receive dial tone.
- Redial the extension number.
- Restore handset.

**EXT** green LED is lit steady.

B	U	S	Y							1	3	7	
1	0	:	4	5	O	C	T		2	8	F	R	I

**EXT** green LED goes off.

1	0	:	4	5	O	C	T		2	8	F	R	I

**EXT** green LED lights.

					E	X	T	L	I	N	E		
1	0	:	4	5	O	C	T		2	8	F	R	I

												1	3	7
1	0	:	4	5	O	C	T		2	8	F	R	I	

1	0	:	4	5	O	C	T		2	8	F	R	I	

SAMPLE LED INDICATIONS

b. From receiving Multiline Terminal:

With message on the LCD:

- Dial 1 repeatedly until the message to be cancelled appears on the LCD.
- Dial \*, within 5 seconds after the message appears.

OR

- Depress primary extension key.
- Lift Handset.
- Dial the extension number which set the callback request message.
- Restore handset.

**3. To Call Back:**

With message on the LCD:

- Dial 1 repeatedly until a callback message appears.

M	S	G	3							
1	0	:	4	5		O	C	T	2	8
									F	R
										I

1	0	:	3	0	S	T	E	V	E		1	3	7
1	0	:	4	5		O	C	T	2	8		F	R
													I

M	S	G	2							
1	0	:	4	5		O	C	T	2	8
									F	R
										I

				E	X	T		L	I	N	E		
1	0	:	4	5		O	C	T	2	8		F	R
													I

												1	3	7
1	0	:	4	5		O	C	T	2	8		F	R	I

M	S	G	2							
1	0	:	4	5		O	C	T	2	8
									F	R
										I

M	S	G	3							
1	0	:	4	5		O	C	T	2	8
									F	R
										I

1	0	:	3	0	S	T	E	V	E		1	3	7
1	0	:	4	5		O	C	T	2	8		F	R
													I

SAMPLE LED INDICATIONS

- Depress primary extension key.
- Lift handset.

Primary 



 green LED lights.

			E	X	T	L	I	N	E
1	0	:	4	5	O	C	T	2	8
								F	R
									I

- Dial the extension number to be called back.

1	0	:	4	5	O	C	T	2	8
								1	3
									7
								F	R
									I

- Converse when party answers.

			S	T	E	V	E		
1	0	:	4	5	O	C	T	2	8
								1	3
									7
								F	R
									I

- Restore handset.

Primary 



 LED goes off.

			M	S	G	2			
1	0	:	4	5	O	C	T	2	8
								F	R
									I

SAMPLE LED INDICATIONS

420.17 Camp-On

1. To Originate:

Upon receiving call waiting tone when transferring a call to a station:

**EXT** green LED is lit steady.

C	A	L	L	W	A	I	T	I	N	G	1	3	7
1	0	:	4	5	O	T	2	8	F	R	I		

- Depress TRF key and receive camp-on tone.

**EXT** LED goes off.

C	A	M	P	O	N	→					1	3	7
1	0	:	4	5	O	C	T	2	8	F	R	I	

- Hang up.

1	0	:	4	5	O	C	T	2	8	F	R	I	

**NOTE:** When camp on is denied, error tone burst followed by call waiting tone or busy tone is heard, and the camping on station is recalled after hanging up.

The station that established the camp on will be recalled if the camped on call is not answered within a predetermined time.

2. To answer:

Upon receiving camp-on tone for a second:

Primary **EXT** green LED is lit steady.

**ANS** LED flashes.

C	A	M	P	O	N	C	O	C	A	L	L		
1	0	:	4	5	O	C	T	2	8	F	R	I	

- Depress ANS key.

**ANS** LED lights steady.

E	L	A	P	S	E	D			0	0	:	5	3
1	0	:	4	5	O	C	T	2	8	F	R	I	

OR

- Restore handset, then receive ring tone.

Primary **EXT** and **ANS** red LED's flash.

- Depress ANS key or primary extension key, then lift handset.

Primary **EXT** green LED lights steady.

**ANS** LED goes off.

L	K	1	6	T	R	C	O	C	A	L	L		
1	0	:	4	5	O	C	T	2	8	F	R	I	

E	L	A	P	S	E	D			0	0	:	5	7
1	0	:	4	5	O	C	T	2	8	F	R	I	

SAMPLE LED INDICATIONS

SAMPLE LCD INDICATIONS

420.18 Tone Override

1. To Originate:

Upon receiving call waiting tone when placing an extension call:

- Dial access code (Default: \*0) or depress DSS key programmed for this access code, and receive override tone.
- Talk to party when answered.

**EXT** green LED is lit steady.

C	A	L	L	W	A	I	T	I	N	G	1	3	7
1	0	:	4	5	O	C	T	2	8	F	R	I	

2. To Answer:

Upon receiving override tone:

- Depress ANS key.
- OR
- Restore handset, then receive ring tone.
- Depress ANS key or primary extension key, then lift handset.

Primary **EXT** green LED is lit steady.  
**ANS** LED flashes.

O	V	E	R	R	I	D	E				1	3	7
1	0	:	4	5	O	C	T	2	8	F	R	I	

**ANS** LED lights steady.

				S	T	E	V	E			1	3	7
1	0	:	4	5	O	C	T	2	8	F	R	I	

Primary **EXT** and **ANS** red LED's flash.

L	K	1	6	S	T	E	V	E			1	3	7
1	0	:	4	5	O	C	T	2	8	F	R	I	

Primary **EXT** green LED lights steady.  
**ANS** LED goes off.

				S	T	E	V	E			1	3	7
1	0	:	4	5	O	C	T	2	8	F	R	I	

SAMPLE LED INDICATIONS

SAMPLE LCD INDICATIONS

420.19 Automatic Callback

1. To Set:

Upon receiving call waiting tone or busy tone when placing an extension call:

- Dial access code (Default: \*1) or depress DSS key programmed for this access code.
- Receive confirmation tone and hang up.
- Primary extension line rings when called station becomes idle.
- Depress ANS key or primary extension line key then lift handset.
- Called station automatically rings or receives voice page.
- Use handset to talk when answered.

**EXT**

green LED is lit steady.

B	U	S	Y								1	3	7		
1	0	:	4	5		O	C	T		2	8		F	R	I

**EXT**

LED goes off.

				C	A	L	L	B	A	C	K		S	E	T
1	0	:	4	5		O	C	T		2	8		F	R	I

**EXT** and **ANS**

LED's flash.

C	A	L	L	B	A	C	K						1	3	7
1	0	:	4	5		O	C	T		2	8		F	R	I

**EXT**

green LED lights.

**ANS**

LED goes off.

1	0	:	4	5		O	C	T		2	8		F	R	I

SAMPLE LED INDICATIONS

SAMPLE LCD INDICATIONS

**2. To Cancel:**

- Depress primary extension line key.
- Lift handset to receive dial tone.
- Redial the extension number.
- Restore handset.

**EXT** green LED lights.

**EXT** LED goes off.

		E	X	T	L	I	N	E		
1	0	:	4	5	O	C	T	2	8	F
										R
										I

B	U	S	Y							1	3	7
1	0	:	4	5	O	C	T	2	8	F	R	I

1	0	:	4	5	O	C	T	2	8	F	R	I

**NOTE:** Any station can set and receive a maximum of 3 automatic callbacks each per station. Automatic callback will time out if unanswered within a predetermined time at originator's station.

SAMPLE LED INDICATIONS

420.20 Account Code Entry

With CO/PBX call in progress:

CO/PBX

green LED is lit steady.

- Depress TRF key and dial # #  
 (If a DSS key is programmed for account code entry, depress the DSS key instead of TRF key followed by dialing # #).
- Dial an account code.
- Automatically go back to conversation.

**NOTE:** A maximum of 14 digit account code can be entered, but number of digits for account code should be assigned by system programming.

SAMPLE LCD INDICATIONS

E	L	A	P	S	E	D			0	0	:	1	5	
1	0	:	4	5	O	C	T		2	8		F	R	I

A	C	C	O	U	N	T	C	O	D	E		?		

									1	2	3	4	5	6

E	L	A	P	S	E	D			0	0	:	2	5	
1	0	:	4	5	O	C	T		2	8		F	R	I



SAMPLE LED INDICATIONS

**420.21 Save and Repeat**

**1. To Save:**

With originating CO/PBX call in progress:

**CO/PBX** green LED is lit steady.

- Depress line key programmed for save & repeat.
- Number dialed is stored into the memory and restore handset.

**S & R** red LED lights.

**CO/PBX** LED goes off.

**S & R** red LED remains lit.

**NOTE:** A maximum of 80 Save & Repeat buffers are provided in a system. Each buffer can contain up to 16 digits. Any Multiline Terminal can have multiple Save & Repeat keys.

**2. To Repeat:**

- Depress an idle extension or CO/PBX line key.
- Lift handset to receive dial tone.
- Depress save & repeat key with LED lit.
- Wait for called party to answer.

**CO/PBX** green LED lights.

**S & R** red LED goes off.

**NOTE:** When an extension line key is used to originate an outside call, system automatically seizes an idle trunk within the trunk group previously used to save the number.

SAMPLE LCD INDICATIONS

E	L	A	P	S	E	D			0	1	:	0	3	
1	0	:	4	5		O	C	T	2	8		F	R	I

	S	A	V	E		&		R	E	P	E	A	T	
1	0	:	4	5		O	C	T	2	8		F	R	I

1	0	:	4	5		O	C	T	2	8		F	R	I

			C	O		L	I	N	E					
1	0	:	4	5		O	C	T	2	8		F	R	I

					5	1	6	7	5	3	7	0	0	0
1	0	:	4	5		O	C	T	2	8		F	R	I

E	L	A	P	S	E	D			0	0	:	1	2	
1	0	:	4	5		O	C	T	2	8		F	R	I

SAMPLE LED INDICATIONS

**420.22 Do Not Disturb**

- Depress line key programmed for Do Not Disturb.

**NOTE:** Following tones are still provided to a Multiline Terminal in DND mode.

Background Music, call from attendant (ring tone only), Boss/Secretary Ring Tone, Recall Tone, Camp-on Tone, Override tone, error tone burst.

**DND**

red LED lights steady.

SAMPLE LCD INDICATIONS

1	0	:	4	5		O	C	T		2	8		F	R	I

SAMPLE LED INDICATIONS

SAMPLE LCD INDICATIONS

**420.23 Call Forward**

**1. From Source Multiline Terminal:**

**a. To Set:**

- Depress primary extension line key.
- Lift handset.
- Dial access code (Default: All Call - 41, Busy/No Answer - 42) or depress DSS key programmed for this access code.
- Dial extension number where incoming calls to your primary extension are forwarded to.
- Receive confirmation tone and hang up.

Primary **EXT**

Primary **EXT** green LED lights.

		EXT	LINE		
10:	45	OCT	28	FRI	

- Dial access code (Default: All Call - 41, Busy/No Answer - 42) or depress DSS key programmed for this access code.
- Dial extension number where incoming calls to your primary extension are forwarded to.
- Receive confirmation tone and hang up.

Primary **EXT**

Primary **EXT** LED goes off.

FWD	ALL	NOT	SET		
10:	45	OCT	28	FRI	

FWD	ALL	137	130		
10:	45	OCT	28	FRI	

10:	45	OCT	28	FRI	

**NOTE:** Access code followed by extension number can be programmed on a DSS key.

**b. To Verify (Only from Multiline Terminal with LCD):**

- Depress primary extension line key.
- Lift handset.
- Dial access code (Default: All Call - 41, Busy/No Answer - 42) or depress DSS key programmed for this access code.

Primary **EXT**

Primary **EXT** green LED lights.

		EXT	LINE		
10:	45	OCT	28	FRI	

FWD	ALL	137	130		
10:	45	OCT	28	FRI	



SAMPLE LED INDICATIONS

- Dial extension number of the destination Multiline Terminal.
- Receive confirmation tone and hang up.

Primary **EXT** LED goes off.

FWD	A	L	L	1	3	7	→	1	3	0
10:	4	5	O	C	T	2	8	F	R	I

10:	4	5	O	C	T	2	8	F	R	I

**NOTE:** DSS key can be also assigned for access code followed by source and destination Multiline Terminals' extension numbers.

b. To Verify (Only from Multiline Terminal with LCD):

- Depress primary extension line key on destination Multiline Terminal.
- Lift handset.
- Dial access code (Default: All Call - 47, Busy/No Answer - 48) or depress DSS key programmed for this access code.
- Dial source extension number.
- Verify call forward setting and hang up.

Primary **EXT** green LED lights.

				E	X	T	L	I	N	E
10:	4	5	O	C	T	2	8	F	R	I

										4	7
10:	4	5	O	C	T	2	8	F	R	I	

FWD	A	L	L	1	3	7	→	1	3	0
10:	4	5	O	C	T	2	8	F	R	I

10:	4	5	O	C	T	2	8	F	R	I

Primary **EXT** LED goes off.

SAMPLE LED INDICATIONS

c. To Cancel:

- Depress primary extension line key on destination Multiline Terminal.
- Lift handset.
- Dial access code (Default: All Call - 47, Busy/No Answer - 48) or depress DSS key programmed for this access code.

**EXT**

Primary **EXT** green LED lights.

		E	X	T	L	I	N	E				
1	0	:	4	5	O	C	T	2	8	F	R	I

- Dial source extension number.

F	W	D	A	L	L	1	3	7	→	1	3	0
1	0	:	4	5	O	C	T	2	8	F	R	I

- Dial \* and receive confirmation tone.

			F	W	D		C	A	N	C	E	L
1	0	:	4	5	O	C	T	2	8	F	R	I

- Hang up.

**EXT**

Primary **EXT** LED goes off.

1	0	:	4	5	O	C	T	2	8	F	R	I

SAMPLE LED INDICATIONS

**420.24 Programming Station Speed Dial and Feature Access Keys**

DSS keys can be programmed to enter station speed dials, feature access codes and the following functions:

Account Code Entry, Boss/Secretary Ring, Last Number Redial, System Speed Dial.

**1. Programming Station Speed Dial**

a. To Program:

a.1 Using DSS key:

- Depress CNF key.
- Depress desired DSS key.
- Dial trunk access code followed by telephone number to be stored.

**CNF** LED flutters.

P	R	O	G	R	A	M	S	P	D	?	?		
---	---	---	---	---	---	---	---	---	---	---	---	--	--

**CNF** LED goes off.

● Depress CNF key.

a.2 Using Dial Access:

- Depress CNF key.
- Dial speed dial buffer number (00 ~ 19).

**CNF** LED flutters.

S	P	D					T	R	K	A	C	?		
---	---	---	--	--	--	--	---	---	---	---	---	---	--	--

S	P	D					T	R	K	A	C	9		
5	1	6	7	5	3	7	0	0	0					

1	0	:	4	5	O	C	T	2	8	F	R	I		

P	R	O	G	R	A	M	S	P	D	?	?		
---	---	---	---	---	---	---	---	---	---	---	---	--	--

S	P	D					T	R	K	A	C	?		
---	---	---	--	--	--	--	---	---	---	---	---	---	--	--

SAMPLE LED INDICATIONS

- Dial trunk access code followed by telephone number to be stored.

S	P	D			T	R	K	A	C	9				
5	1	6	7	5	3	7	0	0	0					

- Depress CNF key.

**CNF**

LED goes off.

1	0	:	4	5	O	C	T	2	8	F	R	I		

**NOTE:** When system speed dial number needs to be entered into speed dial buffer, enter a trunk access code, depress ANS key in place of dialing #, and then enter system speed dial buffer number (20~99). If a pause is required anywhere in the dialing of the number, depress the TRF key (Each depression counts as one of the 16 digits).

b. To Verify (Only from Multiline Terminal with LCD):

b.1 Using DSS key:

- Depress desired DSS key to be verified.
- Check contents of the buffer on the LCD. (The LCD automatically returns to normal mode in about 10 seconds.)

S	P	D			T	R	K	A	C	9				
5	1	6	7	5	3	7	0	0	0					

b.2 Using Dial Access:

1	0	:	4	5	O	C	T	2	8	F	R	I		

- Depress CNF key.

**CNF**

LED flutters.

P	R	O	G	R	A	M	S	P	D	?	?			

- Dial speed dial buffer number (00 ~ 19) to be verified.

S	P	D			T	R	K	A	C	9				
5	1	6	7	5	3	7	0	0	0					



SAMPLE LED INDICATIONS

- Check the contents of the buffer with LCD, then depress CNF key.

**CNF** LED goes off.

c. To Clear:

c.1 Using DSS key:

- Depress CNF key.
- Depress desired DSS key.
- Depress HOLD key.
- Depress CNF key.

**CNF** LED flutters.

**CNF** LED goes off.

c.2 Using Dial Access:

- Depress CNF key.
- Dial speed dial buffer number (00 ~ 19) to be cleared.
- Depress HOLD key.
- Depress CNF key.

**CNF** LED flutters.

**CNF** LED goes off.

SAMPLE LCD INDICATIONS

1	0	:	4	5		O	C	T		2	8		F	R	I

P	R	O	G	R	A	M	S	P	D	?	?			
---	---	---	---	---	---	---	---	---	---	---	---	--	--	--

S	P	D		T	R	K	A	C	9					
5	1	6	7	5	3	7	0	0	0					

S	P	D		T	R	K	A	C	?					
---	---	---	--	---	---	---	---	---	---	--	--	--	--	--

1	0	:	4	5		O	C	T		2	8		F	R	I

P	R	O	G	R	A	M	S	P	D	?	?			
---	---	---	---	---	---	---	---	---	---	---	---	--	--	--

S	P	D		T	R	K	A	C	9					
5	1	6	7	5	3	7	0	0	0					

S	P	D		T	R	K	A	C	?					
---	---	---	--	---	---	---	---	---	---	--	--	--	--	--

1	0	:	4	5		O	C	T		2	8		F	R	I

SAMPLE LED INDICATIONS

2. Programming Feature Access Codes  
 (Multiline Terminal with DSS key Only)

a. To Program:

CNF
-----

 LED flutters.

P	R	O	G	R	A	M	S	P	D	?	?		
---	---	---	---	---	---	---	---	---	---	---	---	--	--

- Depress CNF key.

- Depress desired DSS key.

S	P	D				T	R	K	A	C	?		
---	---	---	--	--	--	---	---	---	---	---	---	--	--

- Dial desired feature access code.

S	P	D				T	R	K	A	C			
6	*												

- Depress CNF key.

CNF
-----

 LED goes off.

1	0	:	4	5		O	C	T	2	8		F	R	I

b. To Verify:

- Depress desired DSS key to be verified.

S	P	D				T	R	K	A	C			
6	*												

- Check contents of the DSS key on the LCD (The LCD automatically returns to normal mode in approximately 10 seconds).

1	0	:	4	5		O	C	T	2	8		F	R	I

c. To Clear:

- Depress CNF key.

CNF
-----

 LED flutters.

P	R	O	G	R	A	M	S	P	D	?	?		
---	---	---	---	---	---	---	---	---	---	---	---	--	--

SAMPLE LED INDICATIONS

- Depress desired DSS key.
- Depress HOLD key.
- Depress CNF key.

**CNF**

LED goes off.

**3. Programming Functions (Multiline Terminal with DSS Key Only)**

a. To Program:

- Depress CNF key.
- Depress desired DSS key.
- Depress ANS key.

**CNF**

LED flutters.

- Dial one of the following digits for various functions:

- Dial 02 (Account Code Entry)
- Dial 03 (Calculator Function)
- Dial 04 (Speed Dial Access)
- Dial 05 (Last Number Redial)
- Dial 06 followed by extension number (Boss/Secretary Ring)

- Depress CNF key.

**CNF**

LED goes off.

SAMPLE LCD INDICATIONS

S	P	D				T	R	K	A	C				
6	*													

S	P	D				T	R	K	A	C	?			

1	0	:	4	5		O	C	T	2	8		F	R	I

P	R	O	G	R	A	M	S	P	D	?	?			

S	P	D				T	R	K	A	C	?			

S	P	D				T	R	K	A	C				
?	?	;												

S	P	D				T	R	K	A	C				
0	3	:	C	A	L	C	U	L	A	T	O	R	F	.

1	0	:	4	5		O	C	T	2	8		F	R	I

SAMPLE LED INDICATIONS

SAMPLE LCD INDICATIONS

b. To Verify:

- Depress desired DSS key.
- Check contents of the DSS key on the LCD (The LCD automatically returns to normal mode in about 10 seconds).

S	P	D																	
0	3	:	C	A	L	C	U	L	A	T	O	R	F	.					

1	0	:	4	5						O	C	T	2	8					F	R	I

c. To Cancel:

- Depress CNF key. CNF LED flutters.
- Depress desired DSS key.
- Depress HOLD key.
- Depress CNF key. CNF LED goes off.

P	R	O	G	R	A	M	S	P	D	?	?									
---	---	---	---	---	---	---	---	---	---	---	---	--	--	--	--	--	--	--	--	--

S	P	D																		
0	3	:	C	A	L	C	U	L	A	T	O	R	F	.						

S	P	D																		
										T	R	K	A	C	?					

1	0	:	4	5						O	C	T	2	8					F	R	I

SAMPLE LED INDICATIONS

**420.25 User Programming**

Each Multiline Terminal can be programmed for the following three features:

- Off Hook Ringing.
- Voice/Tone Signaling.
- Ringing Tone #1/#2.
- Depress CNF key.
- Depress desired line key.

**CNF** LED flutters.

**LK1** ~ **LK3** green LED's light.

LINE KEY NUMBER	FEATURE	LED ON	LED OFF
1	Off Hook Ringing	Yes	No
2	Voice/Tone Signaling	Tone	Voice
3	Ringing Tone	Tone #2	Tone #1

- Depress CNF key.

**CNF** LED goes off.

**LK1** ~ **LK3** green LED's go off.

SAMPLE LCD INDICATIONS

P R O G R A M S P D ? ?

U S E R P R O G R A M

1 0 : 4 5 O C T 2 8 F R I

SAMPLE LED INDICATIONS

420.26 Background Music

1. To Set:

- Depress primary extension line key.
- Lift handset.
- Dial access code (Default: 49) for BGM.
- Dial Channel Number (1 or 2).

Primary EXT green LED lights.

				E	X	T	L	I	N	E	
1	0	:	4	5	O	C	T	2	8	F	R
											I

- Hang up.

Primary EXT LED goes off.

				M	U	S	I	C	N	B	R
1	0	:	4	5	O	C	T	2	8	F	R
											I

- Background music is heard over station speaker.

2. To Cancel:

- Depress primary extension line key.
- Lift handset.

Primary EXT green LED lights.

				E	X	T	L	I	N	E	
1	0	:	4	5	O	C	T	2	8	F	R
											I

- Hang up.

Primary EXT LED goes off.

				M	U	S	I	C	N	B	R
1	0	:	4	5	O	C	T	2	8	F	R
											I

- Make sure that background music is no longer heard over station speaker.

**420.27 Calculation (Multiline Terminal with a Display)**

Calculation function is provided to ETE-6D-1 TEL, ETE-16D-1 TEL and ETE-16K-1 TEL. This calculator function just provides four arithmetic calculations such as addition, subtraction, multiplication and division.

Layout of function keys is as follows:

Each function is printed on DSS key designation paper.

DSS KEY	FUNCTION	DESCRIPTION
1	OFF	Get out of calculation mode
2	Not used	Not used
3	C	Clear the calculator
4	CE	Clear the last entry
5	+	Divide
6	×	Multiply
7	-	Subtract
8	+	Add
9	•	Decimal point
10	=	Equal

SAMPLE LED INDICATIONS

1. Programming DSS Key For Calculator Function:

- Depress CNF key.
- Depress desired DSS key.
- Depress ANS key.
- Dial 03.
- Depress CNF key.

**CNF** LED flutters.

P	R	O	G	R	A	M	S	P	D	?	?

S	P	D				T	R	K	A	C	?

S	P	D				T	R	K	A	C	
?	?	:									

S	P	D				T	R	K	A	C				
0	3	:	C	A	L	C	U	L	A	T	O	R	F	•

**CNF** LED goes off.

1	0	:	4	5	O	C	T	2	8	F	R	I

2. Going Into Calculation Mode:

- Depress the DSS key programmed for calculator function.

3. Getting Out of Calculation Mode:

- In calculation mode:
- Depress DSS key 1; the Multiline Terminal is now in normal mode.

1	0	:	4	5	O	C	T	2	8	F	R	I



#### 4. Calculation

The bottom row of the LCD shows calculation progress indications.

**NOTE:** If nothing appears on the LCD during calculation, do not continue making entries.

a. Addition, Subtraction

Input:  $123 + 456 + 789 =$  Answer: 1368

Input:  $100 - 25 - 35 =$  Answer: 40

Input:  $125 - 55 + 10 =$  Answer: 80

b. Multiplication, Division

Input:  $50 \times 2 \div 4 =$  Answer: 25

Input:  $5 \times =$  (Squared) Answer: 25

c. Combinations of Arithmetic Function

Input:  $1 + 2 \times 3 =$  Answer: 9

Input:  $15 - 3 \div 2 =$  Answer: 6

d. Constant Addition

The first number entered is the addend

Input:  $3 + + 4 =$  Answer: 7

Input:  $5 =$  Answer: 8

The repeat addition works as follows:

Input: 3 + + =      Answer: 6

Input: 3 + + + = =      Answer: 12

e. Constant Multiplication

The first number entered is the multiplicand

Input: 3 × × 4 =      Answer: 12

Input: 5 =      Answer: 15

The repeat multiplication works as follows:

Input: 3 × × =      Answer: 9

Input: 3 × × × = =      Answer: 81

f. Using CE Key

Depress CE key once during a calculation and the last entry is cleared.

Input: 123 + 455 CE 456 =      Answer: 579

5. Error Conditions

In the case of an error, the display shows **ERROR**. An error will be caused by calculations or instructions beyond the capacity. An error can be cleared by depressing the C key.

**Errors will occur when:**

- a. The value of a calculation result, including decimal point and negative sign, exceeds 7 digits (except for a calculation result by division).
- b. A number is divided by 0 (zero).
- c. Number of digits in a particular entry reaches 6; following digit(s) in that entry will be ignored.

SAMPLE LED INDICATIONS

420.28 Station Lockout

**1. To Set:**

- Depress primary extension line key.
  - Lift handset.
- Primary 

EXT
-----

 green LED lights.
- Dial access code (Default: 61).
  - Dial lockout code.
  - Receive confirmation tone and hang up.
- Primary 

EXT
-----

 LED goes off.

**2. To Cancel:**

- Lift handset.
  - Dial access code (Default: 61).
  - Dial lockout code.
  - Receive confirmation tone and hang up.
- Primary 

EXT
-----

 green LED lights.
- Primary 

EXT
-----

 LED goes off.

		EXT	LINE		
10:	45	OCT	28	FRI	

LOCKOUT	CODE	?	
10:	45	OCT	28 FRI

LOCKOUT	SET	#	#
10:	45	OCT	28 FRI

10:	45	OCT	28 FRI

LOCKOUT	CODE	?	
10:	45	OCT	28 FRI

LOCKOUT	CANCEL		
10:	45	OCT	28 FRI

10:	45	OCT	28 FRI

SAMPLE LED INDICATIONS

3. To Change Lockout Code:

- Depress primary extension line key.
- Lift handset.
- Dial access code (Default: 59).
- Dial current lockout code.
- Dial \*.
- Dial new lockout code.
- Dial \*.
- Receive confirmation tone and hang up.

NOTE: Default value of lockout code is 00000000. A maximum number of digits for lockout code is 10.

Station lockout capability is determined by class of service. Callback request message, message waiting and automatic callback can only be set to a station programmed for lockout. Activities on a locked out station are as follows:

- Canceling station lockout.
- Call forward setting prior to station lockout is still valid.

Primary EXT green LED lights.

		EXT	LINE		
1	0	: 4	5	OCT	28 FRI

C	U	R	R	E	N	T	C	O	D	E	?	
1	0	:	4	5	O	C	T	2	8	F	R	I

						#	#	#	#	#	#	
1	0	:	4	5	O	C	T	2	8	F	R	I

	N	E	W	C	O	D	E	?				
1	0	:	4	5	O	C	T	2	8	F	R	I

						#	#	#	#	#	#	
1	0	:	4	5	O	C	T	2	8	F	R	I

	N	E	W	C	O	D	E	S	E	T		
1	0	:	4	5	O	C	T	2	8	F	R	I

1	0	:	4	5	O	C	T	2	8	F	R	I

SAMPLE LED INDICATIONS

420.29 Voice Mail Call

1. Originating:

- Depress primary extension line key.
- Lift handset.
- Dial access code (Default: 63) for voice mail entry port.
- Follow the instructions given by voice mail system when answered.

Primary 

EXT
-----

 green LED lights.

		E	X	T	L	I	N	E	
1	0	:	4	5	O	C	T	2	8
									F
									R
									I

1	0	:	4	5	O	C	T	2	8
									F
									R
									I

				V	M	A	I	L	
1	0	:	4	5	O	C	T	2	8
									F
									R
									I

2. Answering:

- Depress associated extension line key on flashing LED or depress ANS key.
- Lift handset to respond.
- Listen for a message from voice mail system.

EXT
-----

 and 

ANS
-----

 red LED's are flashing.

L	K	1	6		V	M	A	I	L		1	4	0
1	0	:	4	5	O	C	T	2	8		F	R	I

EXT
-----

 green LED lights steady.  

ANS
-----

 LED goes off.

				V	M	A	I	L	
1	0	:	4	5	O	C	T	2	8
									F
									R
									I

NOTE: Some voice mail systems cannot originate calls.

3. Retrieving a Message:

When MSG 2 is shown on the LCD the following operations should be taken to retrieve a message.

M	S	G	2						
1	0	:	4	5	O	C	T	2	8
									F
									R
									I

SAMPLE LED INDICATIONS

- Dial 1 repeatedly until the LCD shows a message from voice mail system.
- Depress primary extension line key.
- Lift handset.
- Call voice mail system by dialing access code (Default: 63) and reach your mail box.
- Listen for a message.

Primary 

EXT
-----

 green LED lights.

1	0	:	3	5	V	M	A	I	L			6	3
1	0	:	4	5	O	C	T	2	8	F	R	I	

			E	X	T	L	I	N	E				
1	0	:	4	5	O	C	T	2	8	F	R	I	

												1	4	0
1	0	:	4	5	O	C	T	2	8	F	R	I		

			V	M	A	I	L					1	4	0
1	0	:	4	5	O	C	T	2	8	F	R	I		

M	S	G	3											
1	0	:	4	5	O	C	T	2	8	F	R	I		

1	0	:	3	5	V	M	A	I	L			6	3	
1	0	:	4	5	O	C	T	2	8	F	R	I		

M	S	G	2											
1	0	:	4	5	O	C	T	2	8	F	R	I		

**4. Canceling a Message:**

For instance, when the LCD is showing **MSG 3** the following operation should be taken to cancel a message:

- Dial 1 until the LCD shows a message from voice mail system.
- Dial \*; the message from voice mail system is canceled.

SAMPLE LED INDICATIONS

5. Abandoning a Call:

- a. Using handset:
  - Restore handset.
    - EXT green LED is lit steady.
    - EXT green LED goes off.
- b. Using Recall key:
  - Depress RECALL key to place another call.
    - EXT green LED is lit steady.
    - EXT green LED remains lit.

SAMPLE LCD INDICATIONS

				V	M	A	I	L		1	4	0		
1	0	:	4	5	O	C	T		2	8		F	R	I

1	0	:	4	5	O	C	T		2	8		F	R	I

				V	M	A	I	L		1	4	0		
1	0	:	4	5	O	C	T		2	8		F	R	I

				E	X	T		L	I	N	E			
1	0	:	4	5	O	C	T		2	8		F	R	I



SAMPLE LED INDICATIONS

SAMPLE LCD INDICATIONS

**420.30 Data Communications**

**A. Internal Data Communications**

**1. Originating:**

a. DTR Signal ON (Manual Answer)

With call in progress:

**EXT**

green LED is lit steady.

- Depress DT key.

Called party depresses DR key to answer.

**DT**

green LED flashes.

**DT**

green LED lights.

**NOTE:** Operation described in parentheses is not done by the user.

b. DTR Signal OFF (Manual Answer)

With call in progress:

**EXT**

green LED is lit steady.

- Depress DT key.

DTR signal becomes ON.

**DT**

red LED lights.

**DT**

green LED flashes.

Called party depresses DR key to answer.

**DT**

red LED lights.

DTR signal from other side DTE becomes ON.

**DT**

green LED lights.

			S	T	E	V	E			1	3	7		
1	0	:	4	6		O	C	T	2	8		F	R	I

			S	T	E	V	E						1	3	7		
D	A	T	A		T	O									1	3	7

			S	T	E	V	E						1	3	7
D	A	T	A		P	A	T	H	T	O			1	3	7

			S	T	E	V	E						1	3	7
1	0	:	4	5		O	C	T	2	8			F	R	I

			S	T	E	V	E						1	3	7		
N	O	T		R	E	A	D	Y							1	3	7

			S	T	E	V	E						1	3	7		
D	A	T	A		T	O									1	3	7

			S	T	E	V	E						1	3	7		
N	O	T		R	E	A	D	Y							1	3	7

			S	T	E	V	E						1	3	7
D	A	T	A		P	A	T	H	T	O			1	3	7

SAMPLE LED INDICATIONS

c. DTR Signal ON (Automatic Answer)

With call in progress.

- Depress DT key.

**EXT** green LED is lit steady.

**DT** green LED lights.

				S	T	E	V	E					1	3	7
1	0	:	4	5		O	C	T		2	8		F	R	I
				S	T	E	V	E							
				D	A	T	A	P	A	T	H		T	O	

d. DTR Signal OFF (Automatic Answer)

With call in progress.

- Depress DT key

DTR signal from calling DTE becomes ON.

DTR signal from called DTE becomes ON.

**EXT** green LED is lit steady.

**DT** red LED lights.

**DT** green LED lights.

				S	T	E	V	E					1	3	7
1	0	:	4	5		O	C	T		2	8		F	R	I
				S	T	E	V	E							
				N	O	T		R	E	A	D	Y			
				S	T	E	V	E					1	3	7
				N	O	T		R	E	A	D	Y			
				S	T	E	V	E					1	3	7
				D	A	T	A	P	A	T	H		T	O	

e. DTR Signal Ineffective by System Data (Manual Answer)

With call in progress.

- Depress DT key

Called party depresses DR key.

**EXT** green LED is lit steady.

**DT** green LED flashes.

**DT** green LED lights.

				S	T	E	V	E					1	3	7
1	0	:	4	5		O	C	T		2	8		F	R	I
				S	T	E	V	E							
				D	A	T	A	T	O						
				S	T	E	V	E					1	3	7
				D	A	T	A	P	A	T	H		T	O	

SAMPLE LED INDICATIONS

c. DTR Signal ON - Calling DTE  
 DTR Signal OFF - Called DTE (Called Party Busy)

- Depress an extensionline key and lift handset to receive dial tone
- Dial extension number.
- Depress DT key.

Called party depresses DR key.

DTR signal from DTE becomes ON.

g. DTR signal On (Called Party Call Waiting)

- Depress an extension line key and lift handset to receive dial tone.
- Dial extension number, then receive call waiting tone.
- Depress DT key

Called party depresses DR key.

SAMPLE LCD INDICATIONS

			EXT			LINE					
		10:	45		OCT	28				FRI	

			BUSY								
		10:	45		OCT	28				FRI	

			BUSY								
			DATA		TO					137	

			BUSY								
			NOT		READY						

			BUSY								
			DATA		PATH		TO			137	

			EXT			LINE					
		10:	45		OCT	28				FRI	

			CALL		WAITING						
		10:	45		OCT	28				FRI	

			CALL		WAITING						
			DATA		TO					137	

			CALL		WAITING						
			DATA		PATH		TO			137	

SAMPLE LED INDICATIONS

h. DTR Signal ON (Call Forwarding is set on Called Party)

• Depressing an extension line key and lift handset to receive dial tone.      **EXT** green LED lights.

• Dial extension number, then receive forward alert tone followed by ringing tone.

• Depress DT key.      **DT** green LED flashes.

Party where the call is forwarded to depresses DR key.      **DT** red LED lights.

SAMPLE LCD INDICATIONS

		E	X	T	L	I	N	E	
1	0	:	4	5	O	C	T	2	8
								F	R
									I

		F	W	D					
					1	3	7	→	
1	0	:	4	5	O	C	T	2	8
								F	R
									I

		F	W	D					
					1	3	7	→	
D	A	T	A	T	O				
								1	3
									0

		F	W	D					
					1	3	7	→	
D	A	T	A	P	A	T	H	T	O
								1	3
									0

SAMPLE LED INDICATIONS

**2. Receiving**

a. DTR Signal ON (Manual Answer)

With call in progress.

**EXT**

green LED is lit steady.

Receive data call.

**DR**

red LED flashes.

● Depress DR key.

**DR**

green LED lights.

			S	T	E	V	E			1	3	7		
1	0	:	4	5		O	C	T	2	8		F	R	I

			S	T	E	V	E			1	3	7		
D	A	T	A		F	R	O	M						

			S	T	E	V	E			1	3	7		
D	A	T	A		P	A	T	H	T	O		1	3	7

b. DTR Signal OFF (Manual Answer)

With call in progress.

**EXT**

green LED is lit steady.

Calling party depresses DT key.

**DR**

red LED lights.

DTR signal from calling DTE becomes ON.

**DR**

red LED flashes.

● Depress DR key.

**DR**

red LED lights.

DTR signal from called DTE becomes ON.

**DR**

green LED lights.

			S	T	E	V	E			1	3	7		
1	0	:	4	5		O	C	T	2	8		F	R	I

			S	T	E	V	E			1	3	7		
N	O	T			R	E	A	D	Y					

			S	T	E	V	E			1	3	7		
D	A	T	A		F	R	O	M						

			S	T	E	V	E			1	3	7		
N	O	T			R	E	A	D	Y			1	3	1

			S	T	E	V	E			1	3	7		
D	A	T	A		P	A	T	H	T	O		1	3	7

SAMPLE LED INDICATIONS

c. DTR Signal ON (Automatic Answer)

With call in progress.

**EXT** green LED is lit steady.

1	0	:	4	5		S	T	E	V	E		
						2	8			F	R	I

Calling party depresses DT key.

**DT** green LED lights.

						S	T	E	V	E								
						D	A	T	A	P	A	T	H	T	O	1	3	7

d. DTR Signal OFF (Automatic Answer)

With call in progress.

**EXT** green LED is lit steady.

1	0	:	4	5		S	T	E	V	E		
						2	8			F	R	I

Calling party depresses DT key.

**DT** red LED lights.

						S	T	E	V	E								
						N	O	T	R	E	A	D	Y			1	3	7

DTR signal from calling DTE becomes ON.

						S	T	E	V	E								
						N	O	T	R	E	A	D	Y			1	3	7

DTR signal from called DTE becomes ON.

**DR** green LED lights.

						S	T	E	V	E								
						D	A	T	A	P	A	T	H	T	O	1	3	7

e. DTR Signal Ineffective by system data (Manual Answer)

With call in progress.

**EXT** green LED is lit steady.

1	0	:	4	5		S	T	E	V	E		
						2	8			F	R	I

Calling party depresses DT key.

**DT** red LED flashes.

						S	T	E	V	E								
						D	A	T	A	F	R	O	M			1	3	7

• Depress DR key.

**DR** green LED lights.

						S	T	E	V	E								
						D	A	T	A	P	A	T	H	T	O	1	3	7

SAMPLE LED INDICATIONS

f. DTR Signal ON (Called Party Busy)

- Talking with an internal party.

**EXT** green LED is lit steady.

Receive a data call from a different internal party.

**DR** red LED flashes.

- Depress DR key.

**DR** green LED lights.

			J	I	M	M	Y			1	3	2		
1	0	:	4	5		O	C	T	2	8		F	R	I

			J	I	M	M	Y			1	3	2	
D	A	T	A		F	R	O	M			1	3	7

			J	I	M	M	Y			1	3	2	
D	A	T	A		P	A	T	H	T	O	1	3	7

g. DTR Signal ON - Calling DTE  
 DTR Signal OFF - Called DTE (Called Party Busy)

- Talking with an internal party.

**EXT** green LED is lit steady.

Receiving a data call from a different internal party.

**DR** red LED flashes.

- Depress DR key.

**DR** red LED lights.

DTR signal from called DTE comes on.

**DR** green LED lights.

			J	I	M	M	Y			1	3	2		
1	0	:	4	5		O	C	T	2	8		F	R	I

			J	I	M	M	Y			1	3	2	
D	A	T	A		F	R	O	M			1	3	7

			J	I	M	M	Y			1	3	2	
N	O	T		R	E	A	D	Y			1	3	1

			J	I	M	M	Y			1	3	2	
D	A	T	A		P	A	T	H	T	O	1	3	7

SAMPLE LED INDICATIONS

h. DTR Signal ON (No Voice Call in Progress).

- Receive an incoming signal.

**EXT** and **ANS** LEDs flash.

L	K	1	6	S	T	E	V	E			1	3	7
1	0	:	4	5	O	C	T	2	8	F	R	I	

Calling party depresses DT key.

**DR** red LED flashes.

L	K	1	6	S	T	E	V	E			1	3	7
D	A	T	A	F	R	O	M				1	3	7

- Depress DR key.

**DR** green LED lights.

L	K	1	6	S	T	E	V	E			1	3	7
D	A	T	A	P	A	T	H	T	O		1	3	7

3. Abandoning

a. Abandoning a Voice Call:

With voice and data call in progress.

**EXT** and **DT** LEDs light steady.

				S	T	E	V	E			1	3	7
				D	A	T	A	P	A	T	H	T	O

- Restore handset.

**EXT** LED goes off.

				D	A	T	A	P	A	T	H	T	O

Called party restores handset.

**NOTE:** Either calling or called party can restore the handset first.



SAMPLE LED INDICATIONS

SAMPLE LCD INDICATIONS

b. Abandoning a Data Call:

b.1 Calling party abandons first:

**EXT** and **DT** green LEDs are lit steady.

			S	T	E	V	E			1	3	7
D	A	T	A	P	A	T	H	T	O			

With voice and data call in progress:

● Depress DT key

**DT** red LED lights.

			S	T	E	V	E			1	3	7
D	A	T	A	E	N	D						

DTR signal from calling DTE goes off; DTR signal from called party goes off; called party depresses the DR key.

**DT** red LED goes off.

			S	T	E	V	E			1	3	7
1	0	:	4	5	O	C	T	2	8	F	R	I

b.2 Called party abandons first:

With voice and data call in progress:

**EXT** and **DT** green LEDs are lit steady.

			S	T	E	V	E			1	3	7
D	A	T	A	P	A	T	H	T	O			

● Called party depresses DR key.

**DT** red LED lights.

			S	T	E	V	E			1	3	7
D	A	T	A	E	N	D						

DTR signal from calling DTE goes off.

			S	T	E	V	E			1	3	7
D	A	T	A	E	N	D						

DTR signal from calling DTE comes on.

**DT** red LED flutters.

			S	T	E	V	E			1	3	7
D	A	T	A	E	N	D						

● Depress DT key.

**DT** red LED goes off.

1	0	:	4	5	O	C	T	2	8	F	R	I

SAMPLE LED INDICATIONS

b.3 Automatic Release:

With voice and data call in progress:

**EXT** and **DT** green LEDs are lit steady.

- Depress DT key.

DTR signal from calling DTE goes off.

**DT** red LED lights.

DTR signal from called DTE goes off.

**DT** red LED goes off.

b.4 DTR Signal Ineffective by System Data:

Calling party abandons first:

With data call in progress:

**DT** green LED lights steady.

- Depress DT key.

Calling party depresses DR key.

**DT** LED goes off.

b.5 DTR Signal Ineffective by System Data:

Called party abandons first:

With data call in progress:

**DT** green LED lights steady.

Called party depresses DR key.

**DT** red LED flutters.

- Depress DT key.

SAMPLE LCD INDICATIONS

			S	T	E	V	E		1 3 7
			P	A	T	H	T	O	1 3 7

			S	T	E	V	E		1 3 7
			E	N	D				1 3 1

			S	T	E	V	E		1 3 7						
			1	0	:	4	5	O	C	T	2	8	F	R	I

			S	T	E	V	E		1 3 7						
			1	0	:	4	5	O	C	T	2	8	F	R	I

			P	A	T	H	T	O	1 3 7

			1	0	:	4	5	O	C	T	2	8	F	R	I

			1	0	:	4	5	O	C	T	2	8	F	R	I

			P	A	T	H	T	O	1 3 7

			E	N	D				1 3 7

			1	0	:	4	5	O	C	T	2	8	F	R	I

SAMPLE LED INDICATIONS

SAMPLE LCD INDICATIONS

7. Loosing DTR Signal When Originating Data Call

With voice call in progress:

- Depress DT key.

DTR signal from calling DTE goes off.

- Depress DT key.

**EXT** green LED is lit steady.

**DT** green LED flashes.

**DT** red LED flutters.

**DT** LED goes off.

			<b>S</b>	<b>T</b>	<b>E</b>	<b>V</b>	<b>E</b>				<b>1</b>	<b>3</b>	<b>7</b>
<b>1</b>	<b>0</b>	:	<b>4</b>	<b>5</b>	<b>O</b>	<b>C</b>	<b>T</b>	<b>2</b>	<b>8</b>		<b>F</b>	<b>R</b>	<b>I</b>

			<b>S</b>	<b>T</b>	<b>E</b>	<b>V</b>	<b>E</b>					<b>1</b>	<b>3</b>	<b>7</b>
<b>D</b>	<b>A</b>	<b>T</b>	<b>A</b>	<b>T</b>	<b>O</b>							<b>1</b>	<b>3</b>	<b>7</b>

			<b>S</b>	<b>T</b>	<b>E</b>	<b>V</b>	<b>E</b>					<b>1</b>	<b>3</b>	<b>7</b>
<b>D</b>	<b>A</b>	<b>T</b>	<b>A</b>	<b>O</b>	<b>F</b>	<b>F</b>						<b>1</b>	<b>3</b>	<b>1</b>

			<b>S</b>	<b>T</b>	<b>E</b>	<b>V</b>	<b>E</b>					<b>1</b>	<b>3</b>	<b>7</b>
<b>1</b>	<b>0</b>	:	<b>4</b>	<b>5</b>	<b>O</b>	<b>C</b>	<b>T</b>	<b>2</b>	<b>8</b>		<b>F</b>	<b>R</b>	<b>I</b>	

8. Reserving Data Path to Originate Data Call

To set:

- Depress DT key.

To cancel from idle condition while in reservation mode:

- Depress DT key.

To cancel from a busy condition with voice call in progress:

- Depress DT key.

**DT** green LED winks intermittently.

**DT** green LED winks intermittently.

**DT** LED goes off.

**EXT** green LED is lit steady.

**DT** green LED winks intermittently.

**DT** green LED flashes.

			<b>D</b>	<b>A</b>	<b>T</b>	<b>A</b>	<b>R</b>	<b>E</b>	<b>S</b>	<b>E</b>	<b>R</b>	<b>V</b>	<b>E</b>			<b>1</b>	<b>3</b>	<b>1</b>
--	--	--	----------	----------	----------	----------	----------	----------	----------	----------	----------	----------	----------	--	--	----------	----------	----------

			<b>D</b>	<b>A</b>	<b>T</b>	<b>A</b>	<b>R</b>	<b>E</b>	<b>S</b>	<b>E</b>	<b>R</b>	<b>V</b>	<b>E</b>			<b>1</b>	<b>3</b>	<b>1</b>
--	--	--	----------	----------	----------	----------	----------	----------	----------	----------	----------	----------	----------	--	--	----------	----------	----------

			<b>1</b>	<b>0</b>	:	<b>4</b>	<b>5</b>	<b>O</b>	<b>C</b>	<b>T</b>	<b>2</b>	<b>8</b>			<b>F</b>	<b>R</b>	<b>I</b>
--	--	--	----------	----------	---	----------	----------	----------	----------	----------	----------	----------	--	--	----------	----------	----------

			<b>D</b>	<b>A</b>	<b>T</b>	<b>A</b>	<b>R</b>	<b>E</b>	<b>S</b>	<b>E</b>	<b>R</b>	<b>V</b>	<b>E</b>			<b>1</b>	<b>3</b>	<b>7</b>
			<b>D</b>	<b>A</b>	<b>T</b>	<b>A</b>	<b>R</b>	<b>E</b>	<b>S</b>	<b>E</b>	<b>R</b>	<b>V</b>	<b>E</b>			<b>1</b>	<b>3</b>	<b>1</b>

			<b>D</b>	<b>A</b>	<b>T</b>	<b>A</b>	<b>R</b>	<b>E</b>	<b>S</b>	<b>E</b>	<b>R</b>	<b>V</b>	<b>E</b>			<b>1</b>	<b>3</b>	<b>7</b>
--	--	--	----------	----------	----------	----------	----------	----------	----------	----------	----------	----------	----------	--	--	----------	----------	----------

			<b>D</b>	<b>A</b>	<b>T</b>	<b>A</b>	<b>S</b>	<b>T</b>	<b>E</b>	<b>V</b>	<b>E</b>					<b>1</b>	<b>3</b>	<b>7</b>
			<b>D</b>	<b>A</b>	<b>T</b>	<b>A</b>	<b>T</b>	<b>O</b>								<b>1</b>	<b>3</b>	<b>7</b>

**SAMPLE LED INDICATIONS**

**SAMPLE LCD INDICATIONS**

b. 2 DTR Signal OFF - called DTE signal rendered ineffective by the system -

Calling DTE:

With voice call in progress:

- Depress DT key.

**EXT** green LED is lit steady.

			S	T	E	V	E					1	3	7
1	0	:	4	5	O	C	T	2	8			F	R	I

**DT** green LED flashes.

			S	T	E	V	E					1	3	7
D	A	T	A	T	O							1	3	7

Called party depresses DR key.

**DT** red LED lights.

			S	T	E	V	E					1	3	7
N	O	T	R	E	A	D	Y					1	3	7

- Depress DT key.

**DT** LED goes off.

			S	T	E	V	E					1	3	7
1	0	:	4	5	O	C	T	2	8			F	R	I

Called party depresses DR key.

			S	T	E	V	E					1	3	7
1	0	:	4	5	O	C	T	2	8			F	R	I

**NOTE:** Called party can depress DR key twice in succession instead.

**6. Failed Data Call Attempt -Called Party's Data Path Busy**

With voice call in progress:

- Depress DT key.
- Depress DT key again.

**EXT** green LED is lit steady.

			S	T	E	V	E					1	3	7
1	0	:	4	5	O	C	T	2	8			F	R	I

**DT** red LED flutters.

			S	T	E	V	E					1	3	7	
D	A	T	A	P	A	T	H					B	U	S	Y

**DT** LED goes off.

			S	T	E	V	E					1	3	7
1	0	:	4	5	O	C	T	2	8			F	R	I

**4. DTR Signal Disconnect**

a. Signal from calling DTE goes off:  
With data call in progress:

DTR signal from calling DTE goes off.

- Depress DT key.

b. Signal from called DTE goes off:

With data call in progress:

DTR signal from called DTE goes off.

DTR signal from calling DTE goes off.

- Depress DT key.

**5. Abandoning During Data Call Origination**

a. Called party does not depress DR key.

a.1 DTR Signal: ON for calling DTE  
OFF from called DTE

With Voice Call in progress:

- Depress DT key.
- Depress DT key again.

DTR signal from calling DTE goes off.

**SAMPLE LED INDICATIONS**

**EXT** and **DT** green LEDs are lit steady.

**DT** red LED flutters.

**DT** LED goes off.

**DT** green LED lights steady.

**DT** red LED lights.

**DT** red LED flutters.

**DT** LED goes off.

**SAMPLE LCD INDICATIONS**

D	A	T	A	P	A	T	H	T	O
									1 3 7
D	A	T	A	O	F	F			
									1 3 1

1	0	:	4	5	O	C	T	2	8
									F R I

NOTE: Bold letters in display indicate flashing letters.

D	A	T	A	P	A	T	H	T	O
									1 3 7
D	A	T	A	O	F	F			
									1 3 7

D	A	T	A	O	F	F			
									1 3 7

1	0	:	4	5	O	C	T	2	8
									F R I

				S	T	E	V	E	
									1 3 7
1	0	:	4	5	O	C	T	2	8
									F R I

D	A	T	A	T	O				
									1 3 7
				S	T	E	V	E	
									1 3 7

D	A	T	A	E	N	D			
									1 3 7
				S	T	E	V	E	
									1 3 7

				S	T	E	V	E	
									1 3 7
1	0	:	4	5	O	C	T	2	8
									F R I

SAMPLE LED INDICATIONS

a. 2 DTR Signal: OFF for both, calling and called DTE

With Voice Call in progress:

- Depress DT key.
- Depress DT key again.

b. Called party depresses DR key.

b.1 DTR Signal: ON for calling DTE  
 OFF for called DTE

With voice call in progress:

- Depress DT key.

Called party depresses DR key.

- Depress DT key.

DTR signal from calling DTE goes off.

Called party depresses DR key.

**EXT** green LED is lit steady.

**DT** red LED lights.

**DT** LED goes off.

**EXT** green LED is lit steady.

**DT** red LED flashes.

**DT** red LED lights.

**DT** LED goes off.

SAMPLE LCD INDICATIONS

				S	T	E	V	E			1	3	7	
1	0	:	4	5		O	C	T	2	8		F	R	I

				S	T	E	V	E			1	3	7
N	O	T		R	E	A	D	Y			1	3	7

				S	T	E	V	E			1	3	7	
1	0	:	4	5		O	C	T	2	8		F	R	I

				S	T	E	V	E			1	3	7	
1	0	:	4	5		O	C	T	2	8		F	R	I

				S	T	E	V	E			1	3	7
D	A	T	A		T	O					1	3	7

				S	T	E	V	E			1	3	7
N	O	T		R	E	A	D	Y			1	3	7

				S	T	E	V	E			1	3	7
D	A	T	A		E	N	D				1	3	7

				S	T	E	V	E			1	3	7	
1	0	:	4	5		O	C	T	2	8		F	R	I

				S	T	E	V	E			1	3	7	
1	0	:	4	5		O	C	T	2	8		F	R	I

SAMPLE LED INDICATIONS

**9. Originating Data Call to Multiline Terminal with Data Reservation**

With voice call in progress:

- Depress DT key.
- Depress DT key again.

**EXT**

green LED is lit steady.

**DT**

red LED flutters.

**DT**

LED goes off.

			S	T	E	V	E			1	3	7		
1	0	:	4	5		O	C	T	2	8		F	R	I

			S	T	E	V	E			1	3	7		
D	A	T	A		R	E	S	E	R	V	E	1	3	7

			S	T	E	V	E			1	3	7		
1	0	:	4	5		O	C	T	2	8		F	R	I

**10. Originating Data Call to Multiline Terminal with CO call in Progress**

a. Called Party - Not Data Reserved

- Depress an idle extension line key and lift handset to receive dial tone.
  - Dial extension number.
  - Depress DT key.
- Called party depresses DR key.

**EXT**

green LED lights.

**DT**

green LED flashes.

**DT**

LED lights.

			E	X	T		L	I	N	E				
1	0	:	4	5		O	C	T	2	8		F	R	I

C	A	L	L		W	A	I	T	I	N	G	1	3	7
1	0	:	4	5		O	C	T	2	8		F	R	I

C	A	L	L		W	A	I	T	I	N	G	1	3	7
D	A	T	A		T	O						1	3	7

C	A	L	L		W	A	I	T	I	N	G	1	3	7
D	A	T	A		P	A	T	H		T	O	1	3	7

SAMPLE LED INDICATIONS

b. Called Party - Data Reserved

- Depress an idle extension line key and lift handset to receive dial tone.
- Dial extension number.
- Depress DT key.
- Depress DT key again.

**EXT**

green LED lights.

		E	X	T	L	I	N	E		
1	0	:	4	5	O	C	T	2	8	F
										R
										I

C	A	L	L	W	A	I	T	I	N	G
1	0	:	4	5	O	C	T	2	8	F
										R
										I

**DT**

red LED flutters.

C	A	L	L	W	A	I	T	I	N	G
D	A	T	A	R	E	S	E	R	V	E
1	3	7								
1	3	7								

**DT**

LED goes off.

C	A	L	L	W	A	I	T	I	N	G
1	0	:	4	5	O	C	T	2	8	F
										R
										I



420.31 Modem Pooling

A. Station Operation

1. Originating:

a. DTR Signal OFF. (Example DTE is a PC that is not in Terminal Mode).

With CO call in progress:

- Depress DT key.
- Place PC in Terminal Mode.

After DTR signal from DTE comes ON; receive ring back tone.

After DSR signal from modem comes ON.

- For Hayes compatible modems; use the PC keyboard and type ATD and then depress the ENTER (return) key.

b. DTR Signal ON. (Example DTE is a PC that is in Terminal Mode).

NOTE: 1. DTE (Data Terminal Equipment) refers to video terminals, personal computers, printers, etc. used for data communications.

2. DTR (Data Terminal Ready). This signal is present when the DTE is available for data communication.

3. DSR (Data Set Ready). This signal is sent from the modem to the DTE when the modem is available for data communication.

SAMPLE LED INDICATIONS

**CO/PBX** green LED is lit steady.

**DT** red LED lights.

**DT** green LED flashes.  
**ANS** LED lights.

**CO/PBX** and **DT** red LEDs light.  
**ANS** LED goes off.  
**DT** green LED lights.

SAMPLE LCD INDICATIONS

E	L	A	P	S	E	D			0	3	:	1	0	
1	0	:	4	5		O	C	T	2	8		F	R	I

E	L	A	P	S	E	D			0	3	:	1	2	
N	O	T		R	E	A	D	Y				1	3	1

												1	4	0			
D	A	T	A		T	O						M	O	D	E	M	2

N	O	T		R	E	A	D	Y				M	O	D	E	M	2

D	A	T	A		O	N	T	O				M	O	D	E	M	2

SAMPLE LED INDICATIONS

With call in progress:

- Depress DT key and receive ring back tone.

**CO/PBX** green LED is lit steady.

**DT** green LED flashes.

**ANS** LED lights.

E	L	A	P	S	E	D				0	3	:	1	0	
1	0	:	4	5		O	C	T		2	8		F	R	I

														1	4	0
D	A	T	A		T	O				M	O	D	E	M	2	

DSR signal from modem comes ON.

**CO/PBX** and **DT** red LEDs light.

**ANS** LED goes off.

N	O	T		R	E	A	D	Y		M	O	D	E	M	2	

- For Hayes compatible modems; use the PC keyboard and type ATD and then depress the ENTER (return) key.

**DT** green LED lights.

D	A	T	A		O	N	T	O		M	O	D	E	M	2	

2. Receiving

a. DTR Signal OFF. (PC not in Terminal Mode).

With CO call in progress:

- Depress DR key and receive ring back tone.

**CO/PBX** green LED is lit steady.

**DR** red LED lights.

**ANS** LED lights.

E	L	A	P	S	E	D				0	3	:	1	0	
1	0	:	4	5		O	C	T		2	8		F	R	I

														1	4	0
N	O	T		R	E	A	D	Y						1	3	1

Ring indicator signal from modem comes ON.

- Place PC in Terminal Mode.

DTR signal from DTE comes ON.

**DR** green LED flashes.

**CO/PBX** and **DR** red LEDs light.

**ANS** LED goes off.

														1	4	0
D	A	T	A		T	O				M	O	D	E	M	2	

N	O	T		R	E	A	D	Y		M	O	D	E	M	2	

SAMPLE LED INDICATIONS

**DR** green LED lights.

**CO/PBX** green LED is lit steady.

**DR** green LED flashes.  
**ANS** LED lights.

**CO/PBX** and **DR** red LEDs light.  
**ANS** LED goes off.

**DR** green LED lights.

D	A	T	A	O	N	T	O	M	O	D	E	M	2

E	L	A	P	S	E	D			0	3	:	1	0	
1	0	:	4	5		O	C	T	2	8		F	R	I

												1	4	0
D	A	T	A	T	O				M	O	D	E	M	2

												1	4	0
D	A	T	A	T	O				M	O	D	E	M	2

N	O	T	R	E	A	D	Y		M	O	D	E	M	2

D	A	T	A	O	N	T	O	M	O	D	E	M	2	

D	A	T	A	O	N	T	O	M	O	D	E	M	2	

													1	3	1
D	A	T	A	E	N	D									

- For Hayes compatible modems; use the PC keyboard and type ATA and then depress the ENTER (return) key.
- b. DTR Signal ON. (PC in Terminal Mode).  
 With CO call in progress:
  - Depress DR key and receive ring back tone.
- Ring indicator signal from modem comes ON.
- DSR signal from modem comes ON.
  - For Hayes compatible modems; use the PC keyboard and type ATA and then depress the ENTER (return) key.

- c. Abandoning
  - a. From Multiline Terminal in the system.
  - a-1. Data call originating from Multiline Terminal.

- With data call in progress:
  - Depress DT key.

SAMPLE LED INDICATIONS

- Take PC out of Terminal Mode (or turn PC off.)

DTR signal from DTE goes OFF.

**DT** LED goes off.

DSR signal from modem goes OFF.

CO/PBX trunk line is released.

**CO/PBX** LED goes off.

A-2. Data call received by Multiline Terminal.

With data call in progress:

**CO/PBX** red LED is lit steady.

**DR** green LED is lit steady.

- Depress DR key.

**DR** red LED lights.

- Take PC out of Terminal Mode (or turn PC off.)

DTR signal from DTE goes OFF.

**DR** LED goes off.

DSR signal from modem goes OFF.

- CO/PBX trunk line is released.

**CO/PBX** LED goes off.

SAMPLE LCD INDICATIONS

1	0	:	4	5		O	C	T		2	8
											F
											R
											I

1	0	:	4	5		O	C	T		2	8
											F
											R
											I

1	0	:	4	5		O	C	T		2	8
											F
											R
											I

D	A	T	A		O	N	T	O		M	O
											E
											M
											2

D	A	T	A		E	N	D				
											1
											3
											1

1	0	:	4	5		O	C	T		2	8
											F
											R
											I

1	0	:	4	5		O	C	T		2	8
											F
											R
											I

1	0	:	4	5		O	C	T		2	8
											F
											R
											I

SAMPLE LED INDICATIONS

b. From Outside Party

b-1. Data call originating from Multiline Terminal.

With data call in progress:

**CO/PBX** red LED is lit steady.  
**DT** green LED is lit steady.  
**DT** red LED lights.

DSR signal from modem goes OFF.

- Take PC out of Terminal Mode (or turn PC off).

DTR signal from DTE goes OFF.

CO/PBX trunk line is released.

- Depress DT key.

**NOTE:** When both automatic release and DTR invalid are assigned by system data, the user does not need to depress DT key to terminate a data call.

b-2. Data call received by Multiline Terminal.

With data call in progress:

**CO/PBX** red LED is lit steady.  
**DR** green LED is lit steady.  
**DR** red LED lights.

DSR signal from modem goes OFF.

SAMPLE LCD INDICATIONS

D	A	T	A	O	N	T	O	M	O	D	E	M	2									

D	A	T	A	O	F	F							M	O	D	E	M	2				

D	A	T	A	O	F	F							M	O	D	E	M	2				

D	A	T	A	O	F	F							M	O	D	E	M	2				

1	0	:	4	5		O	C	T	2	8		F	R	I								

**NOTE:** BOLD letters in display indicate flashing letters.

D	A	T	A	O	N	T	O	M	O	D	E	M	2									

D	A	T	A	O	F	F							M	O	D	E	M	2				

SAMPLE LED INDICATIONS

- Take PC out of Terminal Mode (or turn PC off).

DTR signal from DTE goes OFF.

**DR** red LED flutters.

CO/PBX trunk line is released.

**CO/PBX** LED goes off.

- Depress DR key.

**DR** LED goes off.

**NOTE:** When both automatic release and DTR invalid are assigned by system data, the user does not need to depress DR key to terminate a data call.

**3. Abandoning Data Call while in Process.**

- When Originating:

a-1. Waiting for DTR signal from DTE:

Waiting for DTR signal from DTE to come ON:  
 (PC is off or not in Terminal Mode).

**CO/PBX** green LED is lit steady.  
**DT** red LED is lit steady.

- Depress DT key.

**DT** LED goes off.

SAMPLE LCD INDICATIONS

D	A	T	A	O	F	F			
							M	O	D
							E		M
							2		

D	A	T	A	O	F	F			
							M	O	D
							E		M
							2		

1	0	:	4	5		O	C	T	
						2	8		
						F	R	I	

**NOTE:** BOLD letters in display indicate flashing letters.

E	L	A	P	S	E	D			
							0	3	:
							1	3	1

E	L	A	P	S	E	D			
							0	3	:
							1	3	1

SAMPLE LED INDICATIONS

a-2 Waiting for DSR signal from modem:

Waiting for DSR signal from modem to come ON.

- Depress DT key.
- Take PC out of Terminal Mode (or turn PC off).

DTR signal from DTE goes OFF.

b. When Receiving.

b-1. Waiting for DTR signal from DTE:

Waiting for DTR signal from DTE to come ON:  
 (PC is off or not in Terminal Mode).

- Depress DR key.

b-2. Waiting for DSR signal from modem:

Waiting for DSR signal from modem to come ON:

- Depress DR key.

**CO/PBX** green LED is lit steady.

**DT** green LED is flashing.

**ANS** LED is lit steady.

**DT** red LED lights.

**DT** and **ANS** LEDs go off.

**CO/PBX** green LED is lit steady.

**DR** red LED is lit steady.

**ANS** LED is lit steady.

**DR** and **ANS** LEDs go off.

**CO/PBX** green LED is lit steady.

**DR** green LED is flashing.

**ANS** LED is lit steady.

**DR** red LED lights.

SAMPLE LCD INDICATIONS

											1	4	0
D	A	T	A	T	O			M	O	D	E	M	2

				C	O		L	I	N	E			
D	A	T	A	E	N	D					1	3	1

				C	O		L	I	N	E			
1	0	:	4	5	O	C	T	2	8		F	R	I

												1	4	0
N	O	T		R	E	A	D	Y				1	3	1

				E	L	A	P	S	E	D		0	3	:	1	0
1	0	:	4	5	O	C	T	2	8		F	R	I			

															1	4	0
D	A	T	A	T	O					M	O	D	E	M	2		

				E	L	A	P	S	E	D		0	3	:	1	0	
D	A	T	A	E	N	D									1	3	1

SAMPLE LED INDICATIONS

- Take PC out of Terminal Mode (or turn PC off).

DTR signal from DTE goes OFF.

**DR** and **ANS** LEDs go off.

E	L	A	P	S	E	D			0	3	:	1	3	
1	0	:	4	5		O	C	T	2	8		F	R	I

4. All modems busy.

With CO call in progress:

**CO/PBX** green LED is lit steady.

E	L	A	P	S	E	D			0	3	:	1	0	
1	0	:	4	5		O	C	T	2	8		F	R	I

- Depress DT key.

**DT** red LED flutters.

E	L	A	P	S	E	D			0	3	:	1	2	
				M	O	D	E	M	B	U	S	Y		

- Depress DT key (again).

**DT** LED goes off.

E	L	A	P	S	E	D			0	3	:	1	4	
1	0	:	4	5		O	C	T	2	8		F	R	I

5. Cancelling Reservation to Originate Data Call:

NOTE: With CO call in progress, depressing the DT key to cancel a reserved data path initiates a modem pool data call.

**DT** green LED is winking intermittently.

E	L	A	P	S	E	D			0	3	:	1	0	
D	A	T	A		R	E	S	E	R	V	E	1	3	1

- Depress DT key

**DT** red LED lights.

E	L	A	P	S	E	D			0	3	:	1	2	
N	O	T		R	E	A	D	Y				1	3	1

- Depress DT key again.

**DT** LED goes off.

E	L	A	P	S	E	D			0	3	:	1	4	
1	0	:	4	5		O	C	T	2	8		F	R	I



SAMPLE LED INDICATIONS

430 Attendant Operation

430.1 CO/PBX/TIE (Outside) Calls using the CO Add-On Module:

1. Originating:

a. Manual Dialing

- Depress an idle CO/PBX/TIE line key on the CO Add-On Module.
- Lift handset to receive dial tone.
- Dial desired number.
- Converse with called party.

CO/PBX/TIE

green LED on the CO Add-On Module lights.

				C	O		L	I	N	E					
1	0	:	4	5		O	C	T		2	8		F	R	I

						5	1	6	7	5	3	7	0	0	0
1	0	:	4	5		O	C	T		2	8		F	R	I

E	L	A	P	S	E	D						0	0	:	3	7
1	0	:	4	5		O	C	T		2	8		F	R	I	

b. Last CO/PBX/TIE Number Redial.

- Depress an idle extension or CO/PBX/TIE line key on the CO Add-On Module.
- Lift handset to receive dial tone.
- Dial \* (If \* is assigned to be dialed on CO/PBX/TIE lines as a first digit, depress DSS key assigned for last number redial when using CO/PBX/TIE line keys).
- Converse with called party.

CO/PBX/TIE

green LED on the CO Add-On Module lights.

				C	O		L	I	N	E					
1	0	:	4	5		O	C	T		2	8		F	R	I

						5	1	6	7	5	3	7	0	0	0
1	0	:	4	5		O	C	T		2	8		F	R	I

E	L	A	P	S	E	D						0	0	:	3	7
1	0	:	4	5		O	C	T		2	8		F	R	I	



SAMPLE LED INDICATIONS

- e. Consecutive Dialing:
- Depress an idle CO/PBX/TIE line key on the CO Add-On Module.
  - Lift handset to receive dial tone.
  - Use any combinations of manual dialing, station speed dialing and system speed dialing.
  - Converse with called party.

CO/PBX/TIE

green LED on the CO Add-On Module lights.

SAMPLE LCD INDICATIONS

			C	O	L	I	N	E	
1	0	:	4	5	O	C	T	2	8
								F	R
									I

			4	8	3	5	7	6	9
1	0	:	4	5	O	C	T	2	8
								F	R
									I

			E	L	A	P	S	E	D
1	0	:	4	5	O	C	T	2	8
								0	0
									2
									7
									F
									R
									I

**NOTE:** An additional dialing step may be required in the following cases:

When a system speed dialing sequence follows a manual dialing sequence, DSS key programmed for speed dial access must be depressed prior to accessing the system speed dialing.

When a system speed dialing sequence follows a station or another system speed dialing sequence, DSS key programmed for speed dial access must be depressed prior to accessing the system speed dialing unless the last digit of number stored in the preceding speed dial buffer is \*.

When a station speed dialing sequence (using # followed by speed dial buffer number) follows a manual dialing sequence, it does not function.

When a station speed dialing sequence (using # followed by speed dial buffer number) follows a system or another station speed dialing sequence, it does not function unless the last digit of numbers stored in the preceding speed dial buffer is \*.

SAMPLE LED INDICATIONS

**2. Answering**

**a. Manually Selecting Line:**

- Depress CO/PBX/TIE line key on the CO Add-On Module associated with flashing LED.

**CO/PBX/TIE** and **ANS** red LED's flash.

CK	1	2			CO	CA	LA	LL
I	0	:	4	5	OCT	2	8	FRI

- Use handset to talk.

**CO/PBX/TIE** on the CO Add-On Module green LED lights. **ANS** LED goes off.

EL	AP	S	E	D			0	0	:	0	3
I	0	:	4	5	OCT	2	8	FRI			

**b. Answer Key:**

- Depress ANS key with flashing LED.

**CO/PBX/TIE** on the CO Add-On Module and **ANS** red LED's flash.

CK	1	2			CO	CA	LA	LL
I	0	:	4	5	OCT	2	8	FRI

- Use handset to respond.

**NOTE:** CO line must be programmed for CO ADMOD day ring.

**CO/PBX/TIE** on the CO Add-On Module green LED lights. **ANS** LED goes off.

EL	AP	S	E	D			0	0	:	0	3
I	0	:	4	5	OCT	2	8	FRI			

**NOTE:** Depression of ANS key with call in progress places original call on hold, with I-hold LED indication.

**c. Ringing Line Preference:**

- Lift handset to respond.

**NOTE:** 1) Prime line cannot be assigned for a line key appearing on a CO Add-On module.

**CO/PBX/TIE** on the CO Add-On Module green LED lights. **ANS** LED goes off.

EL	AP	S	E	D			0	0	:	0	3
I	0	:	4	5	OCT	2	8	FRI			

2) Hold, Transfer, and Conference are performed in the same manner as if the line keys were on the Multiline Terminal.

SAMPLE LED INDICATIONS

**430.2 CO Trunk Selection and Test**

a. CO Trunk Selection and Test

- Depress Primary Extension line key.
- Lift handset or depress SPKR key to receive dial tone.
- Dial Selection Access Code: (Default 67).
- Dial Trunk Number (01 ~40) to be selected (Example 03).
- If the selected CO Trunk was idle and in good working order when selected, dial tone will be heard. Digits dialed will appear in the LCD.

**EXT** green LED lit.

EXT	LINE				
10	45	OCT	28	FRI	

**CO/PBX/TIE** red LED will light if the selected trunk appears on the Attendant Multiline Terminal or CO Add-On Module.

					67
10	45	OCT	28	FRI	

					03
10	45	OCT	28	FRI	

		1	2	3	4	5	6	7	8	9
10	45	OCT	28	FRI						

OR

- If the CO trunk selected was busy, Busy Tone will be heard.
- OR
- If the CO Trunk number selected is not installed, Re-order or busied out tone will be heard.
  - Restore handset or depress SPKR key to end testing. Repeat the above steps to test each CO Trunk circuit as required.

CO	3									BUSY
10	45	OCT	28	FRI						

CO	3	NOT	INST	ALL						
10	45	OCT	28	FRI						

CO	3	BUSY	OUT							
10	45	OCT	28	FRI						

10	45	OCT	28	FRI						

**NOTE:** MFR circuits can also be tested, but this must be performed from a Single Line Telephone. Refer to Section 440.3 for this procedure.

SAMPLE LED INDICATIONS

430.3 CO Trunk and MFR Circuit Busy Out/Restore:

- Depress Primary extension line key. EXT green LED lit.
- Lift handset or depress SPKR key to receive dial tone.
- Dial Busy Out/Restore Access Code: (Default 57).
- Dial Trunk Number (01 ~40) or MFR circuit number (41 ~56) to be busied out or restored. The LCD will indicate the current status of the selected circuit.

NOTE: The same "NORMAL" indication is provided regardless of whether the trunk is idle or in use.

OR

Busied out.

OR

Not installed.

- Dial # to busy out the selected circuit. Receive confirmation tone.

NOTE: If the trunk is in use the call in process is dropped after Busy Out.

OR

- Dial \* to restore the selected circuit from Busy Out. Receive confirmation tone.
- Restore handset or depress SPKR to return to standby. Repeat the above steps to Busy Out/Restore additional CO Trunk or MFR circuits as required.

EXT green LED goes off.

SAMPLE LCD INDICATIONS

				EX	T		LI	NE				
			10	:	45		OCT	28			FRI	

			10	:	45		OCT	28			57	
												FRI

			CO									
			10	:	45		OCT	28			FRI	

OR

			CO									
			10	:	45		OCT	28			FRI	

OR

			CO									
			10	:	45		OCT	28			FRI	

			CO									
			10	:	45		OCT	28			FRI	

			CO									
			10	:	45		OCT	28			FRI	

			CO									
			10	:	45		OCT	28			FRI	



SAMPLE LED INDICATIONS

430.5 Attendant Transfer

With call in progress:

- Depress DSS key on the DSS/BLF console, to transfer the call; call is now on non-exclusive hold.
- Voice announcement or ring back tone is heard.
- Depress TRF key on the DSS/BLF Console before party answers.
- OR
- Depress TRF key on the DSS/BLF Console after party answers.

**NOTE:** Called party must press specified line or ANS key to receive transferred call.

Called party's extension will ring or receive camp- on depending upon status.

When transferring a call to an extension, the line key will remain reserved (on hold) until answered at called extension.

Upon completing transfer, the line key LED indication changes as follows: depending on type of line key.

- CO/PBX line key:  
   I-Hold (green) → Lit (red)
- Extension line key:  
   I-Hold (green) → Off

**CO/PBX** green LED is lit steady.

**CO/PBX** green LED winks intermittently.  
**DSS** red LED lights.

**CO/PBX** red LED lights.  
**DSS** red LED remains lit.  
**CO/PBX** red LED lights.  
**DSS** green LED lights.

E	L	A	P	S	E	D				0	3	:	1	2	
1	0	:	4	5		O	C	T		2	8		F	R	I

1	0	:	4	5		O	C	T		2	8		F	R	I

1	0	:	4	5		O	C	T		2	8		F	R	I

1	0	:	4	5		O	C	T		2	8		F	R	I





SAMPLE LED INDICATIONS

430.7 Originating Internal Zone Paging

- Lift handset.
- Depress DSS key on the DSS/BLF console programmed for internal zone paging.
- Use handset to page.

**DSS**

red LED lights.

SAMPLE LCD INDICATIONS

I	N	T	Z	O	N	E	1	P	A	G	E		
1	0	:	4	5		O	C	T	2	8	F	R	I

SAMPLE LED INDICATIONS

**430.6 Originating External Zone Paging**

- Lift handset.
- Depress DSS key on the DSS/BLF console programmed for external zone paging.
- Use handset to page.

DSS

red LED lights.

SAMPLE LCD INDICATIONS

S	P	E	A	K	E	R	1	P	A	G	E	
1	0	:	4	5	O	C	T	2	8	F	R	I

SAMPLE LED INDICATIONS

SAMPLE LCD INDICATIONS

430.9 Message Waiting

1. To Set:

- Depress DSS key on the DSS/BLF console programmed for message waiting.  
**MSG** red LED lights.
- Depress DSS key(s) on the DSS/BLF console where you want to leave a message.  
**DSS** green LED(s) will light.
- Depress MSG key on the DSS/BLF console.  
**MSG** red LED goes off.

2. To Cancel:

- Depress MSG key on the DSS/BLF console.  
**MSG** red LED lights.
- Depress the DSS key(s) on the DSS/BLF console.  
**DSS** green LED(s) will go off.
- Depress MSG key on the DSS/BLF console.  
**MSG** red LED goes off.

**NOTE:** When an attendant is associated with two DSS/BLF consoles, both consoles go into message waiting mode even if only one of the two consoles is put into the message waiting mode.

In the message waiting mode, if no DSS key is depressed within ten seconds, the DSS/BLF console automatically returns to DSS mode.

SAMPLE LED INDICATIONS

SAMPLE LCD INDICATIONS

430.10 Night Transfer

1. To Set:

a. Dial access:

- Depress primary extension line key during day mode.
- Lift handset.
- Dial access code (Default: 68) for night transfer.
- Receive confirmation tone and hang up.

Primary **EXT** green LED lights.

				EXT		LINE			
1	0	:	4	5		OCT	2	8	FRI

Red LED associated with the key programmed for night transfer lights.

Primary **EXT** LED goes off.

1	0	:	4	5		OCT	2	8	FRI

1	0	:	4	5		OCT	2	8	FRI

b. Using NT Key:

- Depress NT key on the DSS/BLF console during day mode (NT: Key programmed for night transfer).

**NT** red LED lights.

1	0	:	4	5		OCT	2	8	FRI

2. To Cancel:

a. Dial Access:

- Depress primary extension line key during night mode.
- Lift handset.

**NT** red LED is lit steady.

1	0	:	4	5		OCT	2	8	FRI

Primary **EXT** green LED lights.

1	0	:	4	5		OCT	2	8	FRI

SAMPLE LED INDICATIONS

- Dial access code(Default: 68) for night transfer. NT red LED goes off.
- Receive confirmation tone and hang up. Primary EXT LED goes off.
- b. Using NT Key:
  - During night mode. NT red LED is lit steady.
  - Depress NT key on the DSS/BLF Console. NT red LED goes off.

**NOTE:** If there are two attendants or more within a tenant, the tenant goes into night mode when either attendant sets night mode.

SAMPLE LCD INDICATIONS

N	I	G	H	T	M	O	D	E	C	N	C	L
1	0	:	4	5	O	C	T	2	8	F	R	I

1	0	:	4	5	O	C	T	2	8	F	R	I

					N	I	G	H	T			
1	0	:	4	5	O	C	T	2	8	F	R	I

1	0	:	4	5	O	C	T	2	8	F	R	I

SAMPLE LED INDICATIONS

430.11 Attendant Camp-On

With Call in Progress:

- Depress DSS key on the DSS/BLF console to transfer the call; call on non-exclusive hold.
- Called party is busy and call waiting tone or busy tone is heard.
- Depress TRF key on the DSS/BLF console.
- Receive confirmation tone and hang up.

**CO/PBX** green LED is lit steady.

**DSS** green LED is lit steady.

**CO/PBX** green LED winks intermittently.

**CO/PBX** red LED lights in place of green.

E	L	A	P	S	E	D			0	2	:	1	4	
1	0	:	4	5		O	C	T	2	8		F	R	I

C	A	L	L		W	A	I	T	I	N	G		1	3	7
1	0	:	4	5		O	C	T	2	8		F	R	I	

C	A	M	P		O	N							1	3	7
1	0	:	4	5		O	C	T	2	8		F	R	I	

1	0	:	4	5		O	C	T	2	8		F	R	I	

**NOTE:** If a camped on call is not answered within a predetermined time, the attendant will be recalled on the line key used for the call unless it is the primary extension line key.

When camp on is denied, error tone burst followed by call waiting tone or busy tone is heard.

SAMPLE LED INDICATIONS

**430.12 Attendant Off-Hook Ringing**

When receiving off-hook ringing with call in progress using handset, one of the following operations can be chosen.

a. Place present call on hold and depress line key with flashing LED to answer the incoming call.

**CO/PBX**  
**EXT** and **ANS**

green LED is lit steady.  
 red LED's are flashing.

E	L	A	P	S	E	D			0	5	:	2	7
1	0	:	4	5	O	C	T	2	8		F	R	I

**CO/PBX**  
**EXT**  
**ANS**

green LED winks intermittently.  
 green LED lights.  
 LED goes off.

				S	T	E	V	E			1	3	7
1	0	:	4	5	O	C	T	2	8		F	R	I

b. Depress ANS key to answer the incoming call and present call is automatically placed on non-exclusive hold.

**CO/PBX**  
**EXT**  
**ANS**

green LED winks intermittently.  
 green LED lights.  
 LED goes off.

				S	T	E	V	E			1	8	7
1	0	:	4	5	O	C	T	2	8		F	R	I

SAMPLE LCD INDICATIONS



**430.13 Station Lockout**

**SAMPLE LED INDICATIONS**

a) Cancellation of Station Lockout

- Depress primary extension line key.

Primary **EXT**

green LED lights.

		E	X	T	L	I	N	E	
1	0	:	4	5	O	C	T	2	8
								F	R
									I

- Lift handset.

		E	X	T	N	U	M	B	E
1	0	:	4	5	O	C	T	2	8
								F	R
									I

- Dial access code (Default: 62).

		L	O	C	K	O	U	T	
1	0	:	4	5	O	C	T	2	8
								F	R
									I

- Dial extension number of the station when lock out is to be cancelled.

		1	0	:	4	5	O	C	T
								2	8
								F	R
									I

Primary **EXT** green LED goes off.

b) Default of secret lockout code.

- Depress primary extension line key.

Primary **EXT**

green LED lights.

- Lift handset.

		C	O	D	E	C	A	N	C
1	0	:	4	5	O	C	T	2	8
								F	R
									I

- Dial access code (Default: 62)
- Dial extension number of station requiring lockout code defaulted to 0000000000.

		C	O	D	E	C	A	N	C
1	0	:	4	5	O	C	T	2	8
								F	R
									I

- Dial \* to default station lockout secret code and receive confirmation tone.

		1	0	:	4	5	O	C	T
								2	8
								F	R
									I

Primary **EXT** green LED goes off.

- Hang up.

**NOTE:** To default the lockout code of a station that is in the lockout mode you must first cancel the station lockout.

SAMPLE LED INDICATIONS

430.14 Call Forward Set/Verify/Cancel

SAMPLE LCD INDICATIONS

1. To Set:

- Depress primary extension line key.
- Lift handset.
- Dial access code (Default: All Call - 44; Busy/No Answer - 45).
- Dial source extension number (where calls are forwarded from).
- Dial destination extension number (where calls are forwarded to).

Primary 

EXT
-----

 green LED lights.

			EXT	LINE		
1	0	:	4	5	OCT	2 8 FRI

						4 4
1	0	:	4	5	OCT	2 8 FRI

FWD	ALL	NOT	SET
1	0	:	4 5 OCT 2 8 FRI

FWD	ALL	1 3 7	→	1 3 0
1	0	:	4 5 OCT 2 8 FRI	

- Receive confirmation tone and hang up.

Primary 

EXT
-----

 green LED goes off.

1	0	:	4	5	OCT	2 8 FRI

2. To Verify:

- Depress primary extension line key.
- Lift handset.
- Dial access code (Default: All Call - 44; Busy/No Answer - 45).
- Dial source extension number.
- Check with LCD and hang up.

Primary 

EXT
-----

 green LED lights.

			EXT	LINE		
1	0	:	4	5	OCT	2 8 FRI

						4 4
1	0	:	4	5	OCT	2 8 FRI

FWD	ALL	1 3 7	→	1 3 0
1	0	:	4 5 OCT 2 8 FRI	

1	0	:	4	5	OCT	2 8 FRI

Primary 

EXT
-----

 green LED goes off.



SAMPLE LED INDICATIONS

**430.15 Programming System Speed Dial**

An attendant can program, erase and verify system speed dial allotted to the tenant. Allocation of system speed dial buffers to each tenant must be done by system programming.

**1. To Program:**

**CNF** LED flutters.

P	R	O	G	R	A	M	S	P	D	?	?		
---	---	---	---	---	---	---	---	---	---	---	---	--	--

- Dial #.

P	R	O	G	R	A	M	S	Y	S	S	P	D	?	?
---	---	---	---	---	---	---	---	---	---	---	---	---	---	---

- Dial desired system speed dial buffer number (20 ~ 99).

S	P	D	4	5					T	R	K	A	C	?
---	---	---	---	---	--	--	--	--	---	---	---	---	---	---

- Dial trunk access code followed by telephone number you want to enter.

S	P	D							T	R	K	A	C	7	3
5	1	6	7	5	3	7	0	0							

- Depress ANS key to enter the number you programmed.

P	R	O	G	R	A	M	S	Y	S	S	P	D	?	?
---	---	---	---	---	---	---	---	---	---	---	---	---	---	---

(When programming system speed dial consecutively, dial another system speed dial buffer number after depressing ANS key).

**CNF** LED goes off.

1	0	:	4	5					O	C	T	2	8		F	R	I
---	---	---	---	---	--	--	--	--	---	---	---	---	---	--	---	---	---

**2. To Verify:**

**CNF** LED flutters.

P	R	O	G	R	A	M	S	P	D	?	?		
---	---	---	---	---	---	---	---	---	---	---	---	--	--

- Dial #

P	R	O	G	R	A	M	S	Y	S	S	P	D	?	?
---	---	---	---	---	---	---	---	---	---	---	---	---	---	---

SAMPLE LED INDICATIONS

- Dial desired system speed dial buffer number (20 ~ 99).
- To verify the contents of speed dial buffers consecutively, depress ANS key and dial another speed dial buffer.

- Depress CNF key.

**3. To Delete:**

- Depress CNF key.
- Dial #.
- Dial desired system speed dial buffer number (20 ~ 99).
- Depress HOLD key.
- Depress ANS key.

(When deleting the contents of speed dial buffers consecutively, dial another buffer number and depress HOLD, ANS key).

- Depress CNF key.

**CNF** LED goes off.

**CNF** LED flutters.

**CNF** LED goes off.

SAMPLE LCD INDICATIONS

S	P	D	4	5		T	R	K	A	C	7	3
5	1	6	7	5	3	7	0	0				

1	0	:	4	5		O	C	T	2	8		F	R	I

P	R	O	G	R	A	M	S	P	D	?	?		

P	R	O	G	R	A	M	S	Y	S	S	P	D	?	?

S	P	D	4	5		T	R	K	A	C	7	3
5	1	6	7	5	3	7	0	0				

S	P	D	4	5		T	R	K	A	C	?	

P	R	O	G	R	A	M	S	Y	S	S	P	D	?	?

1	0	:	4	5		O	C	T	2	8		F	R	I

SAMPLE LED INDICATIONS

**430.16 Clock/Calendar Setting**

The clock/calendar can be set from the attendant Multiline Terminal only.

**EXAMPLE: Friday, July 4, 1986, 8:35 A.M.**

1. Depress CNF key and \*.

**CNF**

LED flutters.

2. Hour Setting: Dial 0, 8.

P	R	O	G	R	A	M	C	L	O	C	K
H	O	U	R							?	?

3. Depress DSS key 20.  
(See NOTE 4)

P	R	O	G	R	A	M	C	L	O	C	K
H	O	U	R							0	8

4. Minute Setting: Dial 3, 5.

P	R	O	G	R	A	M	C	L	O	C	K
M	I	N	U	T	E					?	?

5. Depress DSS key 20.

P	R	O	G	R	A	M	C	L	O	C	K
M	I	N	U	T	E					3	5

6. Day Setting: Dial 0, 4.

P	R	O	G	R	A	M	C	L	O	C	K
D	A	Y								?	?

7. Depress DSS key 20.

P	R	O	G	R	A	M	C	L	O	C	K
D	A	Y								0	4

8. Month Setting: Depress line key 7.  
(See NOTE 1)

P	R	O	G	R	A	M	C	L	O	C	K
M	O	N	T	H						?	?

9. Depress DSS key 20.

P	R	O	G	R	A	M	C	L	O	C	K
M	O	N	T	H						0	7

P	R	O	G	R	A	M	C	L	O	C	K
Y	E	A	R							?	?

SAMPLE LED INDICATIONS

SAMPLE LCD INDICATIONS

P	R	O	G	R	A	M		C	L	O	C	K	
Y	E	A	R								8	6	

1	0	:	4	5		O	C	T		2	8		F	R	I
---	---	---	---	---	--	---	---	---	--	---	---	--	---	---	---

10. Year Setting: Dial 8, 6.  
 (See NOTE 3)

11. Depress ANS key to enter data.  
 (See NOTE 4)

CNF

LED goes off.

**Note 1: Valid Entries**

Hour: 00 ~ 23  
 Minute: 00 ~ 59  
 Day: 01 ~ 31  
 Month: JAN ~ DEC (set by line key)

**Month entry:**

LK1	LK2	LK3	LK4	LK5	LK6	LK7	LK8
JAN	FEB	MAR	APR	MAY	JUNE	JULY	AUG
LK9	LK10	LK11	LK12	LK13	LK14	LK15	LK16
SEP	OCT	NOV	DEC				

**Note 2: Day of the Week, Leap Year**

Day of the week and leap year will be automatically set by entering month, date and year data.

**Note 3: Year Data Entry:**

If year data is 86 or greater than 86, the year is automatically considered 1986 ~ 1999. If less than 86, the year is considered 2000 ~ 2085.

**Note 4: DSS Key 20, ANS Key:**

Depression of DSS key 20 advances setting mode. LCD goes back to show Hour Setting mode after Year Setting mode by depressing DSS key 20.

Depression of ANS key enters data, and the LCD automatically returns to normal mode.

**Note 5: Error Conditions:**

When invalid data is entered, error tone is heard. Enter valid data and depress DSS key 20 to proceed.



#### 440 Single Line Telephone Operation

##### 440.1 CO/PBX (Outside) Calls

###### 1. Originating:

###### a. Manual Dialing:

- Lift handset and receive dial tone.
- Dial trunk access code (Default: 9, 8, 70 ~ 75).
- Dial number for outside party.
- Converse when called party answers.

###### b. Station Speed Dialing:

- Lift handset and receive dial tone.
- Dial # followed by station speed dial buffer number (00 ~ 19) *associated with outside party to be dialed.*
- Converse when called party answers.

###### c. System Speed Dialing:

- Lift handset and receive dial tone.
- Dial # followed by system speed dial buffer number (20 ~ 99) *associated with outside party to be dialed.*

- Converse when called party answers.

###### d. Last CO/PBX Number Redial:

- Lift handset and receive dial tone.
- Dial \* for last number redial.
- Converse when called party answers.

###### e. Consecutive Dialing:

- Lift handset and receive dial tone.

Use some combinations of manual dialing, station speed dialing and system speed dialing.

**NOTE:** Consecutive dialing cannot be made in the following cases:

- Station or system speed dialing sequence follows a manual dialing sequence.
- Station or system speed dialing sequence follows another speed dialing sequence.

###### 2. Answering:

- Lift handset and converse.

### 3. Placing A Call On Hold

With call in progress:

- Hook flash to receive second dial tone.
- Dial access code (Default: 4 #) to place call on exclusive hold and hang up.

- Lift handset to place another call or to retrieve the held party by dialing access code (Default: 4 #).

### 4. Abandoning a Call

- Restore handset.

#### 440.2 Extension (Internal) Calls/Step Call

##### 1. Originating:

- Lift handset and receive dial tone.
- Dial desired extension number.
- Converse when called party answers.

##### 2. Step Calling:

Step Calling: After calling an extension (Example: 111) and receiving Busy Tone or Call Waiting Tone:

- Dial a new Last Digit (Example: 2), receive Ring Back Tone; wait for called party (Ext. 112) to answer; converse.

##### 3. Answering:

- Lift handset and converse.

##### 4. Placing a Call on Hold:

With call in progress:

- Hook flash to receive second dial tone.
- Dial access code (Default: 4#) to place the call on hold and hang up.
- Lift handset to place another call or to answer the held call by dialing access code (Default: 4 #).

##### 5. Abandoning a Call:

- Restore handset.

#### 440.3 MFR Circuit Selection and Test

- Lift handset, receive dial tone.
- Dial Selection Access Code (Default 67).
- Dial MFR device number (41~56) to be selected and tested.
  - if the MFR circuit selected is idle and in good working order, dial tone will be heard.

OR

- if it is busy, busy tone will be heard.

OR

- if it is not installed or busied out, re-order tone will be heard.
- Restore handset. Repeat the steps above to test all MFR circuits required.

**NOTE:** MFR circuits can be busied out or restored only by an attendant's Multiline Terminal. Refer to Section 430.3 for the procedure.

#### 440.4 Trunk Queuing

##### A. To set a Trunk Queue:

After attempting to seize a CO/PBX/TIE trunk via dial access and receiving busy tone because all of the trunks in that group are busy:

- Dial Trunk Queue Access Code, \*1, receive confirmation tone.
- Restore handset.

##### B. Receiving Trunk Queue Recall:

As soon as a trunk within the trunk group, to which the trunk queue was set, and the station which set the queue are idle, CO/PBX/TIE ringing will be received;

- Lift handset, receive CO/PBX/TIE dial tone.
- Dial desired number.

- Converse.

##### C. To cancel a Trunk Queue:

- Lift handset, receive dial tone.
- Dial any Trunk Access code.
- Restore handset.

Trunk Queue will be automatically cancelled if the recall to the station is not answered within a pre-programmed time interval.

**NOTE:** Trunk Queuing cannot be accessed by any station that is assigned LCR. If this is attempted re-order tone will result.

Recall will not occur until both a trunk in the queue group and the extension which set the queue are both idle.

#### 440.5 Transfer

With call in progress:

- Hook flash; call on consultation hold.
- Dial extension number to be transferred to.
- When ring back tone is heard, restore handset (Transfer is completed when party answers).

OR

- When party answers, restore handset (Transfer is completed).

OR

- When call waiting tone is heard, restore handset (original call is camped on to busy extension).

**NOTE:** Unanswered transferred or camped on call will recall the station that initiated the transfer after the recall time interval has elapsed.

- Hook flash; original conference goes on consultation hold and parties on hold can still talk to each other.

- Call third party.
- Converse when called party answers.
- Hook flash to establish a four party conference.

**NOTE:** Four party conference calls cannot be transferred by any means.

### 3.Placing a Conference Call on Hold

With conference call in progress:

- Hook flash; conference call goes on consultation hold.
- Dial access code for exclusive hold (Default: 4 #).
- Restore handset.

**NOTE:** When a four party conference is already in progress, this conference call cannot be placed on hold.

### 4. Abandoning a Conference Call

- Restore handset.

### 440.6 Conference

Possible conferences are as follows:

- 4 stations - No CO/PBX lines
- 3 stations - No CO/PBX lines
- 3 stations - 1 CO/PBX lines
- 2 stations - 1 CO/PBX lines
- 2 stations - 2 CO/PBX lines
- 1 station - 2 CO/PBX/TIE lines

#### 1. Three Party Conference

With call in progress:

- Hook flash; original call goes on consultation hold.
- Call second party.
- Converse when called party answers.
- Hook flash to establish a three party conference.

**NOTE:** Three party conference calls can be transferred by establishing four party conference and by dropping from the conference.

#### 2. Four Party Conference

With three party conference in progress:

### 440.7 Unsupervised Conference

#### 1. To Establish

With three party conference including two CO/PBX parties in progress:

- Hook flash and receive second dial tone.
- Dial access code (Default: 4 #) for exclusive hold.
- Restore handset.

#### 2. To Reenter the Conference

- Lift handset and receive dial tone.
- Dial access code (Default: 4 #) to reenter the conference.

#### 3. To Answer Conference Recall

After a predetermined time since an unsupervised conference is established.

- The SLT rings for recall.
- Lift handset to answer the conference recall.

#### 4. Abandoning a Conference

After reentering the conference or answering the conference recall.

- Restore handset.



#### 440.8 Internal Zone Paging

##### 1. To Originate:

- Lift handset and receive dial tone.
- Dial access code and page.

Default values are as follows: (Last digit of each access code is fixed).

550 - All Call  
551 - Zone 1  
552 - Zone 2  
553 - Zone 3  
554 - All Zones

##### 2. To Answer (Meet-me):

- Lift handset and receive dial tone.
- Dial access code (Default value is 556. Last digit of the access code is fixed).
- Converse with paging party.

#### 440.9 External Zone Paging

##### 1. To Originate:

- Lift handset.
- Dial access code and page.

Default values are as follows: (Last digit of each access code is fixed).

561 - Zone 1  
562 - Zone 2  
563 - Zone 3  
564 - All Zones

##### 2. To Answer (Meet-me):

- Lift handset and receive dial tone.
- Dial access code (Default value is 566. Last digit of the access code is fixed).
- Converse with paging party.

#### 440.10 Consultation Hold (Broker's Call)

The status of consultation hold comes about during the process of transfer, conference or broker's call. When a station having consultation hold goes on-hook, the station will be immediately recalled.

##### 1. Transfer or Conference:

With call in progress:

- Hook flash; first party goes on consultation hold.

- Dial second party.

- Consult with second party when answered.

- Hang up to complete transfer, or hook flash to establish a conference.

OR

- When second party (internal) hangs up, the station is reconnected to the first party.

##### 2. Broker's Call:

a. Originating:

With call in progress:

- Hook flash to receive second dial tone.

- Dial access code (Default: 4 #) to place first party on exclusive hold.

- Receive dial tone and call second party.

- Converse with second party when answered.

- Hook flash and dial access code (Default: 4 #) to place second party on exclusive hold.

The station is automatically reconnected to the first party.

b. Answering:

With call in progress:

- The station receives camp on or override tone, then hook flash and dial access code (Default: 4 #) to place first call on exclusive hold.

- Hang up and receive ring tone.

- Lift handset to answer the second call.

- Hook flash and dial access code (Default: 4 #) to place the second call on exclusive hold.

The station is automatically reconnected to the first party.

**NOTE:** In such cases as a. and b., successive access to exclusive hold alternates the connection between the first and second parties.

#### 440.11 Call Park

##### A. To Park a Call:

With an extension, CO/PBX/TIE or conference call in progress:

- Provide Hook Flash, receive second dial tone (call is placed on Consultation Hold).
  - Dial Call Park Access Code (Default 4\*).
  - Dial Call Park Location Number (0~9) Example: 0, receive confirmation tone.
- OR
- if the Call Park Location number dialed is busy (busy tone received):

- Use step calling to advance to an idle call park location.  
Example: Dial 1, receive confirmation tone.

- Restore handset.

##### B. Retrieving a Call from Park:

- Lift handset, receive dial tone.
- Dial Call Park Access Code (Default 4\*).
- Dial Call Park Location number (0~9) of the call to be retrieved; converse. If mistakingly an idle Call Park location number is dialed, reorder tone will be heard.

Any call left in Call Park for more than a pre-programmed interval will recall to the station which parked the call. This recall can be picked up by other stations in the system via Directed Call Pickup.

If you park a **CNF** call or put a **CNF** call on exclusive hold, you cannot retrieve another Parked Call and you cannot answer another recalling parked conference call.

**440.12 Dial 0 For Attendant**

- Lift handset and receive dial tone
- Dial 0 to call the associated attendant

**NOTE:** When the associated attendant is busy, calls to the attendant can be routed to another attendant, depending upon system programming. If the associated attendant is call forwarded to another station, calls to the attendant will be automatically forwarded to the station.

#### 440.13 Call Pickup

##### 1. Call Pickup - Directed

Another station is receiving an incoming call:

- Lift handset and receive dial tone.
- Dial access code (Default: 6 #).
- Dial the extension number receiving the incoming call.
- Converse with calling party.

**NOTE:** Incoming calls to be picked up are as follows: CO/PBX calls, Extension Calls, Transferred Calls, Hold Recalls, Transfer Recalls, Voice paged calls.

##### 2. Call Pickup - Group

- Another station is receiving an incoming call.

- Lift handset and receive dial tone.
- Dial access code (Default: 6\*) and converse with calling party.

**NOTE:** To pick up incoming calls a station must be within a call pickup group.

Incoming calls that can be picked up are CO/PBX calls, extension calls and transferred calls.

#### 440.14 Night Call Pickup

With incoming CO/PBX call presented during night mode:

- Lift handset and receive dial tone.
- Dial access code (Default: 60).
- Converse with calling party.

**NOTE:** Incoming calls that can be picked up are CO/PBX calls only.

#### 440.15 Callback Request Message

#### 2. To Cancel:

##### 1. To Set:

Upon receiving call waiting tone, busy tone or no answer when placing an extension call:

- Dial access code (Default: #).
- Receive confirmation tone and hang up.
- Lift handset and receive dial tone.
- Redial the extension number.
- Restore handset.

**NOTE:** Access code must be dialed within a predetermined time after dialing the extension number.

**440.16 Camp-On**

**1. To Originate:**

Upon receiving call waiting tone when transferring a call to a station:

- Restore handset.

**NOTE:** The station originating camp on will be recalled when camp-on is denied or when camped on call is not answered within a predetermined time.

**2. To Answer:**

With call in progress, receive camp on tone:

a. Terminating Present Call:

- Hang up to terminate present call.
- Lift handset to answer the camped on call when station rings.

b. Placing Present Call on Exclusive Hold:

- Hook flash to receive second dial tone.
  - Dial access code (Default: 4 #) to place present call on exclusive hold.
  - Hang up, then receive ring tone.
  - Lift handset to answer the camped on call.
  - Restore handset to terminate the camped on call, then lift handset to retrieve the exclusive held call by dialing access code (Default: 4 #).
- OR
- Hook flash and dial access code (Default: 4 #) to place the camped on call on exclusive hold, then converse with the exclusive held party again (Broker's Call).

#### 440.17 Tone Override

##### 1. To Originate:

Upon receiving call waiting tone when placing an extension call:

- Dial access code (Default: \*0).
- Receive override tone.
- Talk to party when answered.

**NOTE:** Access code must be dialed within a predetermined time after dialing the extension number.

##### 2. To Answer:

With call in progress, receive override tone:

##### a. Terminating Present Call:

- Hang up to terminate present call.

- Lift handset to answer the tone overridden call when station rings.

##### b. Placing Present Call on Exclusive Hold:

- Hook flash to receive second dial tone.
- Dial access code (Default: 4#) to place present call on exclusive hold.
- Hang up, then receive ring tone.
- Lift handset to answer the tone overridden call.
- Restore handset to terminate the tone overridden call, then lift handset to retrieve the exclusive held call by dialing access code (Default: 4#).

**OR**

- Hook flash and dial access code (Default: 4#) to place the tone overridden call on exclusive hold, then converse with the exclusive held part again (Broker's Call).



#### 440.18 Automatic Callback

##### 1. To Set:

Upon receiving call waiting tone or busy tone when placing an extension call:

- Dial access code (Default: \*1).
- Receive confirmation tone and hang up.
- The station setting automatic callback rings when called station becomes idle.
- Lift handset and wait for called station to answer.
- Converse with called party.

**NOTE:** Access code must be dialed within a predetermined time after dialing the extension number.

##### 2. To Cancel:

- Lift handset and receive dial tone.
- Redial the extension number.
- Restore handset.

**NOTE:** Any station can set and receive a maximum of 3 automatic callbacks each per station. Automatic callback will be cancelled if unanswered within a predetermined time at originator's station.

#### 440.19 Account Code Entry

With CO/PBX call in progress:

- Hook flash and dial #, #.

- Dial an account code.
- Automatically go back to conversation.

**NOTE:** A maximum of 14 digit account code can be entered, but number of digit for account code should be determined by system programming.

## 440.20 Call Forward

### 2. From Destination SLT

#### 1. From source SLT

##### a. To Set:

- Lift handset and receive dial tone.
- Dial access code (Default: All call - 41, Busy/No Answer - 42).
- Dial destination station's extension number.
- Receive confirmation tone and restore handset.

##### b. To Cancel:

- Lift handset and receive dial tone.
- Dial access code (Default: All Call - 41, Busy/No Answer - 42).
- Dial \*
- Receive confirmation tone and restore handset.

##### a. To Set:

- Lift handset and receive dial tone.
- Dial access code (Default: All Call - 47, Busy/No Answer - 48).
- Dial source station's extension number.
- Dial destination SLT's extension number.
- Receive confirmation tone and restore handset.

##### b. To Cancel:

- Lift handset and receive dial tone.
- Dial access code (Default: All Call - 47, Busy/No Answer - 48).
- Dial source station's extension number.
- Dial \*
- Receive confirmation tone and restore handset.

#### 440.21 Programming Station Speed Dial

- Lift handset and receive dial tone.
- Dial access code (Default: 58) and speed dial buffer number (00 ~ 19).
- Dial trunk access code.
- Dial number to be stored.
- Restore handset.

**440.22 Station Lockout**

**3. Change of Lockout Code:**

- Lift handset and receive dial tone.
- Dial access code (Default: 59) and current lockout code.
- Dial \*, new lockout code and \*
- Receive confirmation tone and restore handset.

**NOTE:** Default value of lockout code is 0000000000. A maximum number of digits for lockout code is 10.

Station lockout capability is determined by class of service assignment. Message waiting and automatic callback can be set to a station programmed for lockout. Activities on a locked out station are as follows:

- 1. To Set:**
- Lift handset and receive dial tone.
  - Dial access code (Default: 61) and lockout code.
  - Receive confirmation tone and restore handset.

- 2. To Cancel:**
- Lift handset.
  - Dial access code (Default: 61) and lockout code.
  - Receive confirmation tone and restore handset.

- Canceling station lock out
- Call forward setting prior to station lockout is still valid.

#### 440.23 Voice Mail Call

##### 1. To Originate:

- Lift handset and receive dial tone.
- Dial access code (Default: 63) for voice mail entry port.
- Follow the instructions given by voice mail system when answered.

##### 2. To Answer:

- Lift handset.
- Listen for a message from voice mail system.

**NOTE:** Some voice mail systems cannot originate calls.

##### 3. Retrieving a Message:

SLT's with message lamp can only indicate a message on the lamp. Therefore, the following operation only applies to SLT with message lamp. (See Notes 1 & 2).

When message lamp is lit:

- Lift handset and receive dial tone.
- Dial access code (Default: 63) for voice mail entry port and reach your mail box.
- Listen for a message.

**NOTE 1:** Some voice mail systems cannot leave a message on a station, others can.

**NOTE 2:** Attendant Multiline Terminals can also leave a message on a single line telephone with message lamp. Therefore, in some cases, there may be no message from voice mail even when message lamp is lit.

##### 4. Canceling a Message:

Retrieving a message from voice mail cancels the message indication.

##### 5. Abandoning a Call:

- Restore handset.

## **450 Executive Multiline Terminal Operation**

### **450.1 General**

ETE-16K-1 Multiline Terminal is the Executive Multiline Terminal described in Section 170 of this manual.

The unique DIRECTORY feature with large display is available only to this Multiline Terminal.

Standard system features other than the Directory feature also apply to this Multiline Terminal, therefore, only operations of the DIRECTORY with large display are described in this section.

+









SAMPLE LED INDICATIONS

e. Depress DIR key to program trunk access code and telephone number to be stored.

f. Dial trunk access code and telephone number to be stored.

g. Depress CNF key to enter trunk access code and telephone number.

Station speed dial has been programmed into the DSS key, then the Multiline Terminal goes back to the end of step b. and repeats step c. through step g. for another station SPD programming. If another station speed dial is necessary to be programmed into a DSS key in another page, go back to on-line by depressing CNF key again and repeat step a. through step g.

h. Depress CNF key to go back to on-line mode.

**CNF** LED goes off.

**NOTE 1:** When changing the name only, skip steps e. and f. after step d., and perform steps g. and h.

SAMPLE LCD INDICATIONS

SPD				TRK	AC	?		
P	A	T	T					

SPD				TRK	AC	7	3	
5	1	6	7	5	3	7	0	0
P	A	T	T					

P	R	O	G	R	A	M	S	P	D	?	?
P	A	T	T								

1	0	:	4	5	O	C	T	2	8	F	R
N	E	I	L		S	T	E	V	E		
M	E	L	I	S	S	A	J	I	M	M	Y
A	L	I	C	E			J	O	H	N	
N	A	N	C	Y			M	I	K	E	
P	A	G	E				F	W	D	A	L



SAMPLE LED INDICATIONS

c. Depress desired DSS key.

d. Depress HOLD key to erase name.

To retain the same name, depress DIR key instead.

e. Depress DIR key.

f. Depress HOLD key to erase present trunk access code and telephone number.

To retain the same number, skip steps e. and f.

SAMPLE LCD INDICATIONS

P	R	O	G	R	A	M	S	P	D			
C	H	A	R	L	E	S		P	A	U	L	
J	O	A	N									
G	E	O	R	G	E							
R	O	C	K	Y								
P	E	T	E	R								

P	R	O	G	R	A	M	S	P	D			
C	H	A	R	L	E	S		P	A	U	L	
J	O	A	N									
G	E	O	R	G	E							
R	O	C	K	Y								
P	E	T	E	R								

S	P	D					T	R	K	A	C	7	3
5	1	6	7	5	3	7	0	0	0				
C	H	A	R	L	E	S				P	A	U	L
J	O	A	N										
G	E	O	R	G	E								
R	O	C	K	Y									
P	E	T	E	R									

S	P	D					T	R	K	A	C	?	
C	H	A	R	L	E	S				P	A	U	L
J	O	A	N										
G	E	O	R	G	E								
R	O	C	K	Y									
P	E	T	E	R									

SAMPLE LED INDICATIONS

g. Depress CNF key.

The Multiline Terminal goes back to the end of step b. Repeat step c. through g. to clear another station speed dial.

If it is necessary to clear another station speed dial on a different page, go back to on-line mode by depressing CNF key again, and repeat step a. through step g.

h. Depress CNF key again to go back to on-line mode.

**CNF**

LED goes off.

SAMPLE LCD INDICATIONS

P	R	O	G	R	A	M	S	P	D	?	?
C	H	A	R	L	E	S	P	A	U	L	
J	O	A	N				M	A	R	Y	
G	E	O	R	G	E		D	O	U	G	
R	O	C	K	Y							
P	E	T	E	R			F	R	A	N	

1	0	:	4	5	O	C	T	2	8	F	R	I
N	E	I	L				S	T	E	V	E	
M	E	L	I	S	A		J	I	M	M	Y	
A	L	I	C	E			J	O	H	N		
N	A	N	C	Y			M	I	K	E		
P	A	G	E				F	W	D	A	L	L







**CHAPTER 5**  
**MAINTENANCE**



## CHAPTER 5 MAINTENANCE

SECTION DESCRIPTION	PAGE
<b>510 GENERAL</b>	500-1
<b>520 OPERATIONAL CURRENT AND VOLTAGE CHECK</b>	500-1
<b>530 OPERATIONAL TEST PROCEDURES</b>	
530.1 General	500-2
530.2 Before Initialization	500-2
530.3 System Initialization	500-2
530.4 After Initialization	500-2
<b>540 TROUBLESHOOTING FLOW CHARTS</b>	
540.1 Problem Solving	500-3

### SECTION 510 GENERAL

This Chapter is to be used as a guide for troubleshooting the system during and after installation. The troubleshooting flow charts and general test procedures will help the technician to identify the cause of a problem by defining the problem area and isolating the valid symptoms.

### SECTION 520 OPERATIONAL CURRENT AND VOLTAGE CHECKS

The effectiveness of this portion of the maintenance section depends upon the technician's ability to answer correctly all questions posed as accurately as possible. Due to external factors, it is important that no answer be assumed. For example, it cannot be assumed that a power supply is working properly

Table 520-1

VOLTAGES	TOLERANCE	MEASURING POINTS
<u>Module 1</u> +5 volts -5 volts -24 volts	+5 ± 0.25 volts -5 ± 0.25 volts -24 ± 2.0 volts	CPU-EB: TP1 GND TP2 +5V TP3 -5V TP4 -24V
<u>Modules 2 and 3</u> +5 volts -5 volts -24 volts	+5 ± 0.25 volts -5 ± 0.25 volts -24 ± 2.0 volts	MMC-E: TP1 GND TP2 +5V TP3 -5V TP4 -24V
<u>AC Voltage (117 VAC)</u> Hot to Neutral Hot to Conduit Ground Neutral to Conduit Ground	117 ± 10% VAC 117 ± 10% VAC .05 VAC (MAX.)	AC TERMINAL STRIP N to L G to L G to N
Ring Generator (SLT)	70~ 120 VRMS @ 20 Hz*	Across TIP & RING of any ringing SLT
<u>CO Line</u> Off-hook line current	25 to 50 mA	In series with TIP side of CO line at MDF
<u>Module 1, 2 &amp; 3</u> (PSE-DD-1) -48 volts input	-48 ± 8volts	On the input Terminal Strip of PSE-DD-1 -48V

\*NOTE: Measurement of ring voltage may be lower if the meter is designed for measuring 60 Hz signals only.

because it has replaced another power supply. It is necessary to test the output of the power supply with a meter, to be sure. This is why, before a technician can attempt any troubleshooting, the correct tools should be available.

1. Digital or Analog Multimeter, capable of reading:
  - A. DC current and voltage
  - B. AC current and voltage
  - C. DC Resistance
2. Test Set, linemen's, being capable of:
  - A. Termination and Monitor modes
  - B. DTMF and Dial Pulse dialing
3. Hand tools:
  - A. Set of Screwdrivers (common and cross head blades)
  - B. Set of Pliers, Long nose and diagonals
  - C. Punch down tool
4. The complete Electra MarkII Installation/Service Manual with all the latest up-to-date information, as well as the **completed job specifications**.

## SECTION 530 OPERATIONAL TEST PROCEDURES

**530.1** When the Electra MarkII system is first powered up it runs through an initialization process. During this process the CPU-EB ETU, in module 1, scans each of the twenty four interface slots to determine the hardware configuration used. This information is stored in the Resident System Program memory with the system default values. Section 530 provides test procedures to be used before, during and after this initialization process.

### **530.2 Before Initialization**

It is important that the following steps be taken by the installation technician:

- A. **Cable Connections**  
All wiring for power supplies, RSG, flat cable connectors, etc., should be checked for good solid connections. Refer to Chapter 2 (Hardware Installation) of this manual for connection instructions.
- B. **AC/DC Power**  
With an AC/DC meter, check all power (See Table 520-1). It is recommended that this test be run

-with only the TSW-E, CPU-EB ETUs and 1 or 2 MMC-E(s) installed in the CCUs, on two and three cabinet configurations.

### **C. Initialization Check**

To check if the system is initializing correctly, it is suggested that only Module 1 be powered up with the CPU-EB, TSW-E and one ESI-EB ETU with terminals installed. After initialization, all the terminals assigned to this ESI-EB ETU should be able to call each other via intercom. (These stations by default will be assigned station numbers 100-103; the first two terminals must be ETE-16D-1).

### **530.3 System Initialization**

Once the previous steps are completed and checked, the entire system should be initialized. **With the power off**, all the interface and option cards can be installed in each module as indicated on the job specification document. It is important to check that the battery switch on the CPU-EB ETU is turned off and all interface and option ETU switches are on. At this point the technician can power up the system. During the power up procedure, each display terminal will temporarily display INITIALIZE. After the initialization process, each station display will show default time and date indication: 12:00 JAN 01 SUN.

At this time, it is recommended that a first initialization (Memory Block 3D-1) be executed from one of the system programming stations (first two ESI-E( ) ports) after the power up of the system. See Chapter 3 of this manual.

### **530.4 After Initialization**

Before any programming is attempted, the battery switch on the CPU-EB ETU should be turned on. This will prevent all completed programming from being lost, if the system loses power.

At this point, all ports may be checked in software, to ensure the initialization process scanned all hardware correctly. This can be done by displaying the contents of Memory Block 1E-5 on the system programming Terminal. (Refer to Section 330 for explanation of Memory Blocks.)

After all previous steps have been checked and any problems found corrected, the system programming can be completed. Use of the job specification sheets, also supplied in Section 370, simplifies the programming process.

**CAUTION:** Ensure the battery switch on the CPU-EB ETU is turned ON.

The next step is for the technician to run a Second Initialization (not a First Initialization; a First Initialization causes all programming memory to be lost.) The Second Initialization cleans out or refreshes the system RAM without any loss of programming.

This completes the installation procedure for the Electra MarkII System. The technician should, at this point, check the operation of each Multiline Terminal to ensure the system is working properly.

## SECTION 540 TROUBLESHOOTING FLOW CHARTS

### 540.1 Problem Solving

To find the cause of a problem, first consider all the symptoms carefully. As each aspect of the problem is considered, the technician is guided to a probable solution. It is imperative the problem be defined as accurately as possible, so the most efficient steps to a solution can be taken. The troubleshooting flow charts, in this section, will help define a problem and direct the technician through the troubleshooting steps.

#### 1. SYSTEM DOWN

Although this term is used to describe many

conditions, it will only be used in this section to describe one of the following situations:

- a. No access to internal dial tone on any Multiline Terminal or Single Line Telephone installed.
- b. No LED indications or no display indications on any Multiline Terminal installed.
- c. No system tones are generated.

#### 2. PARTIAL OPERATION

This term will refer to any situation which cannot be completely described under the conditions of a **SYSTEM DOWN**. (Refer to the index table listing these conditions.)

#### 3. RESET DEFINITION

In the troubleshooting flow charts, the technician is at times directed to reset the station and/or ETU.

- a. Station Reset - Is accomplished by unplugging the station line cord from the station and then plugging it back in.
- b. ETU Reset - The ETUs are reset by turning the ON/OFF switch on the ETU to the OFF position and then turning it back ON. To give capacitors in the ETU time to discharge, allow some time before turning the switch back to the ON position.

INDEX TABLE

CONDITION	FLOW CHART NUMBER	PAGE NUMBER
<b>A. SYSTEM DOWN</b>		
1. No Internal Dial Tone To Any Multiline Terminal or Single Line Telephone.	A1	500-5
2. No LED or Display Indications On Any Multiline Terminal.	A2	500-6
3. No System Tones Are Available.	A3	500-7
<b>B. PARTIAL OPERATIONS</b>		
1. Radio Frequency Interference (RFI).	B1	500-8
2. Central Office Line Problems:		
a. Intermittent ring Problems.	C1	500-9
b. Calls Dropping.	C2	500-10
c. No Outside Dial Tone Access.	C3	500-11
d. CO Signaling Problem.	C4	500-12
3. Multiline Terminal Problems:		
a. Terminal Function Problem.	D1	500-13
b. Ringing Problems.	D2	500-14
c. Dial Tone Access Problems.	D3	500-15
4. Single Line Telephone Problems:		
a. No Dial Tone Access.	E1	500-16
b. Ringing Problem.	E2	500-17
c. No Dial Access To Features.	E3	500-18
5. Low Volume Problems.	F1	500-19
6. External Paging Problem.	G1	500-20
7. Station Message Detail Recording (SMDR) Problems (No Call Accounting System)	H1	500-21

A1

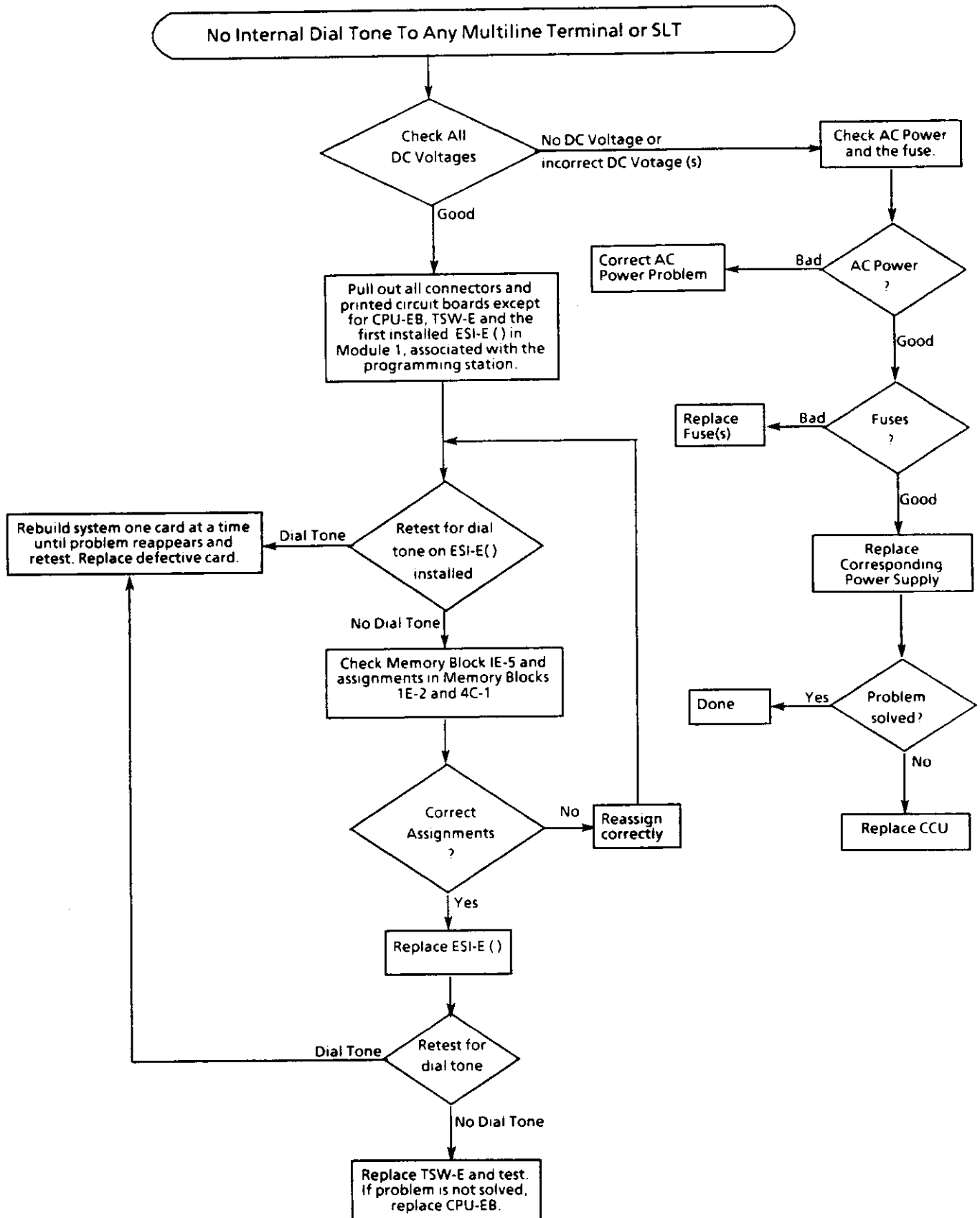

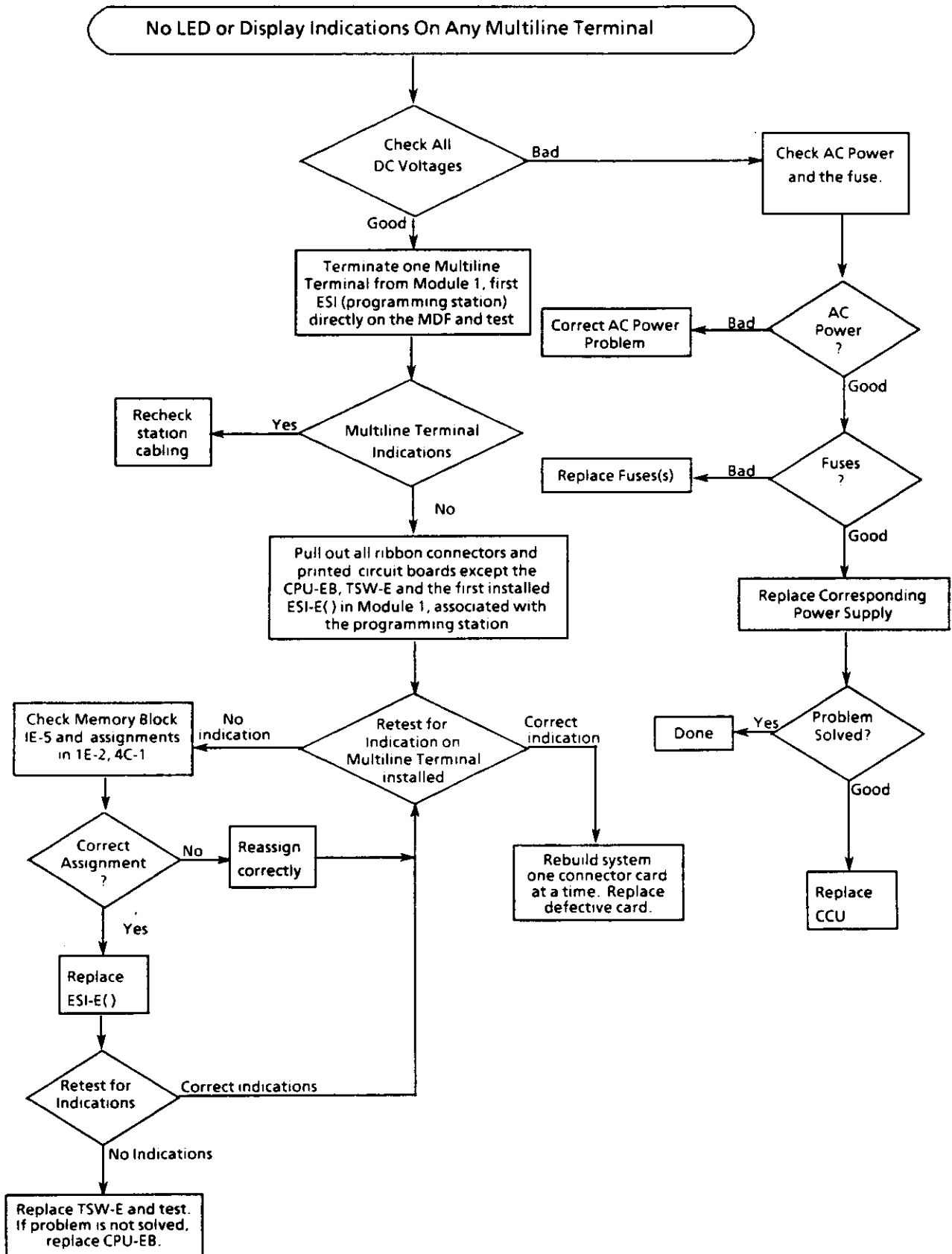



A3

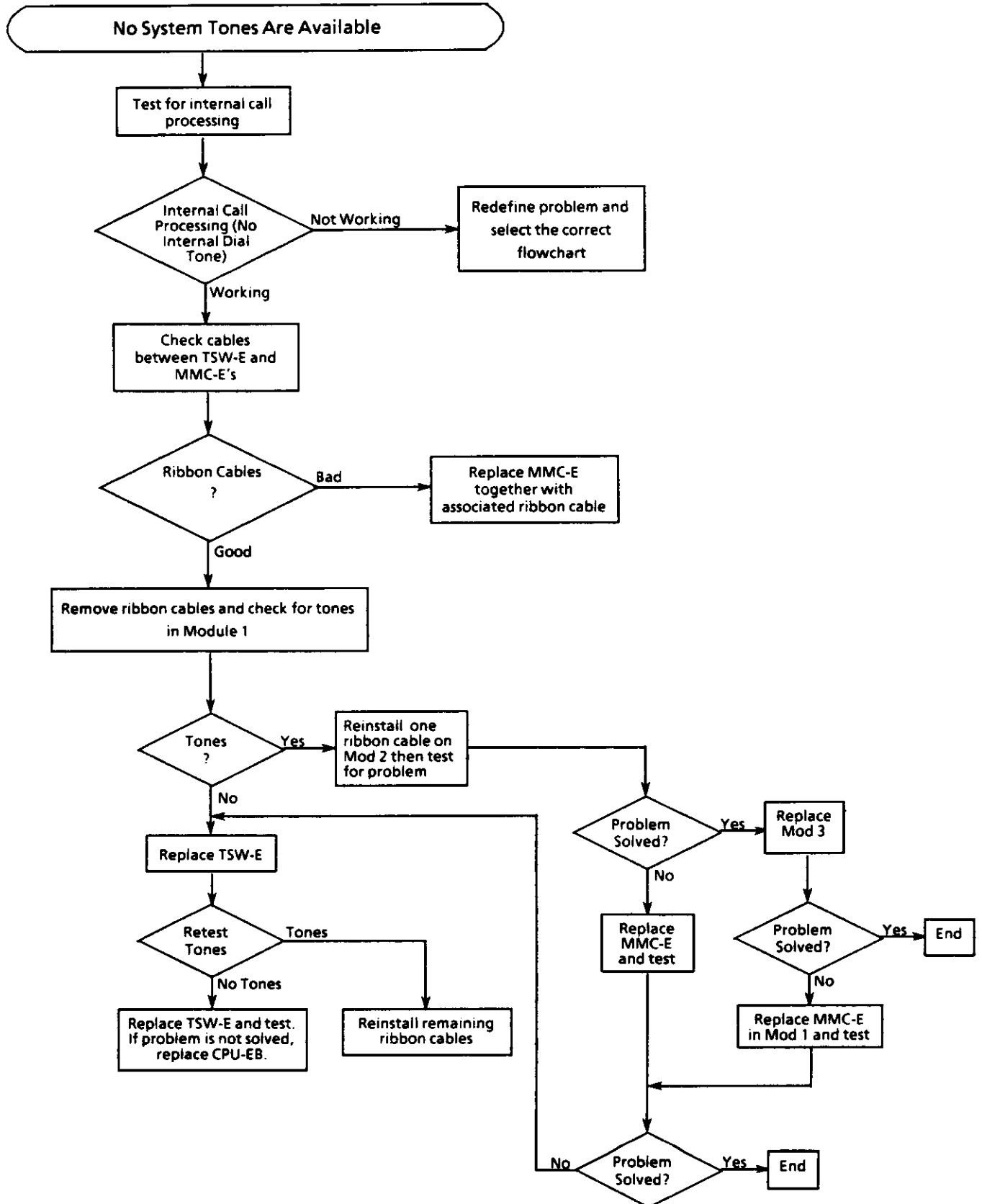

B1

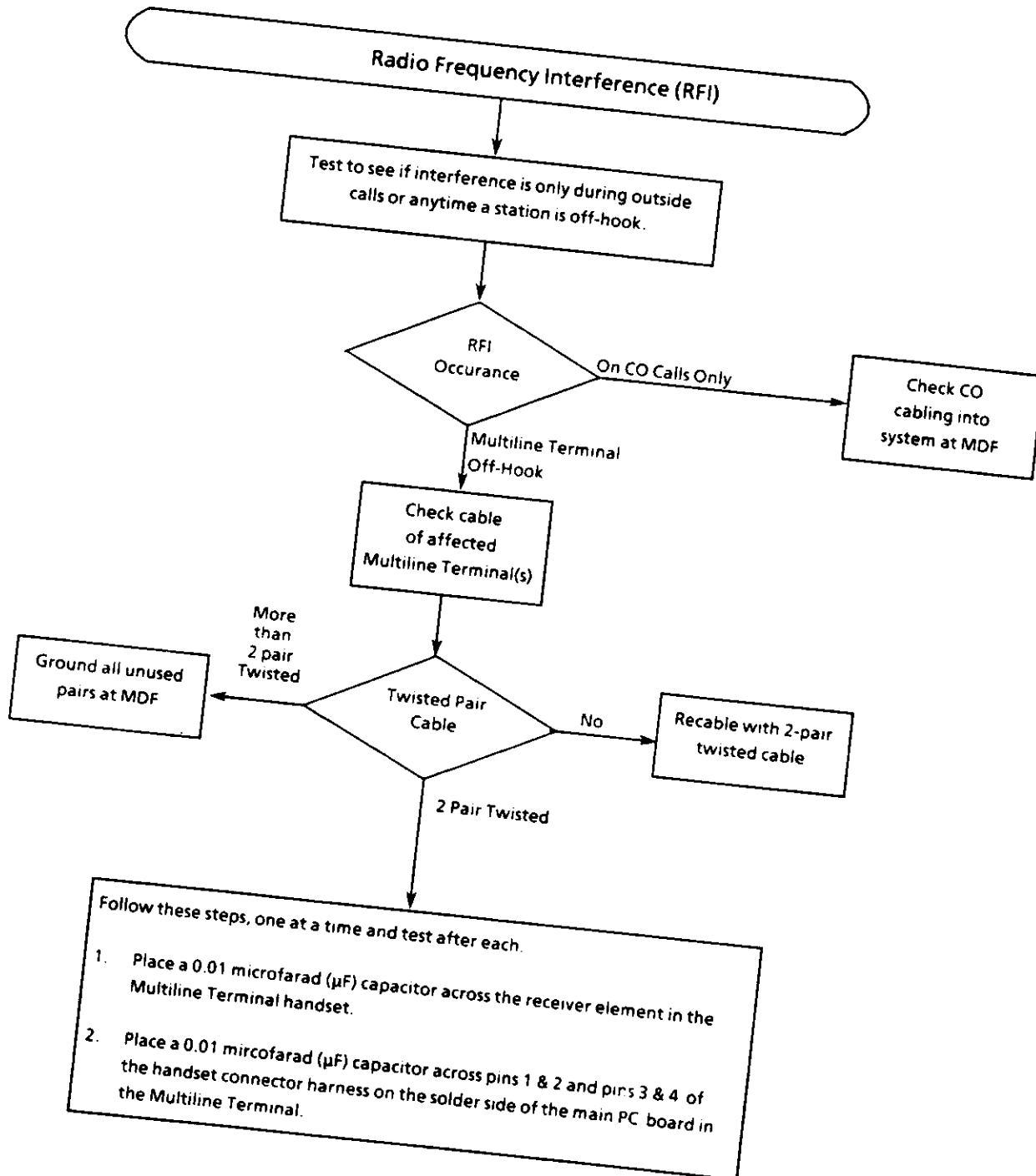

C1

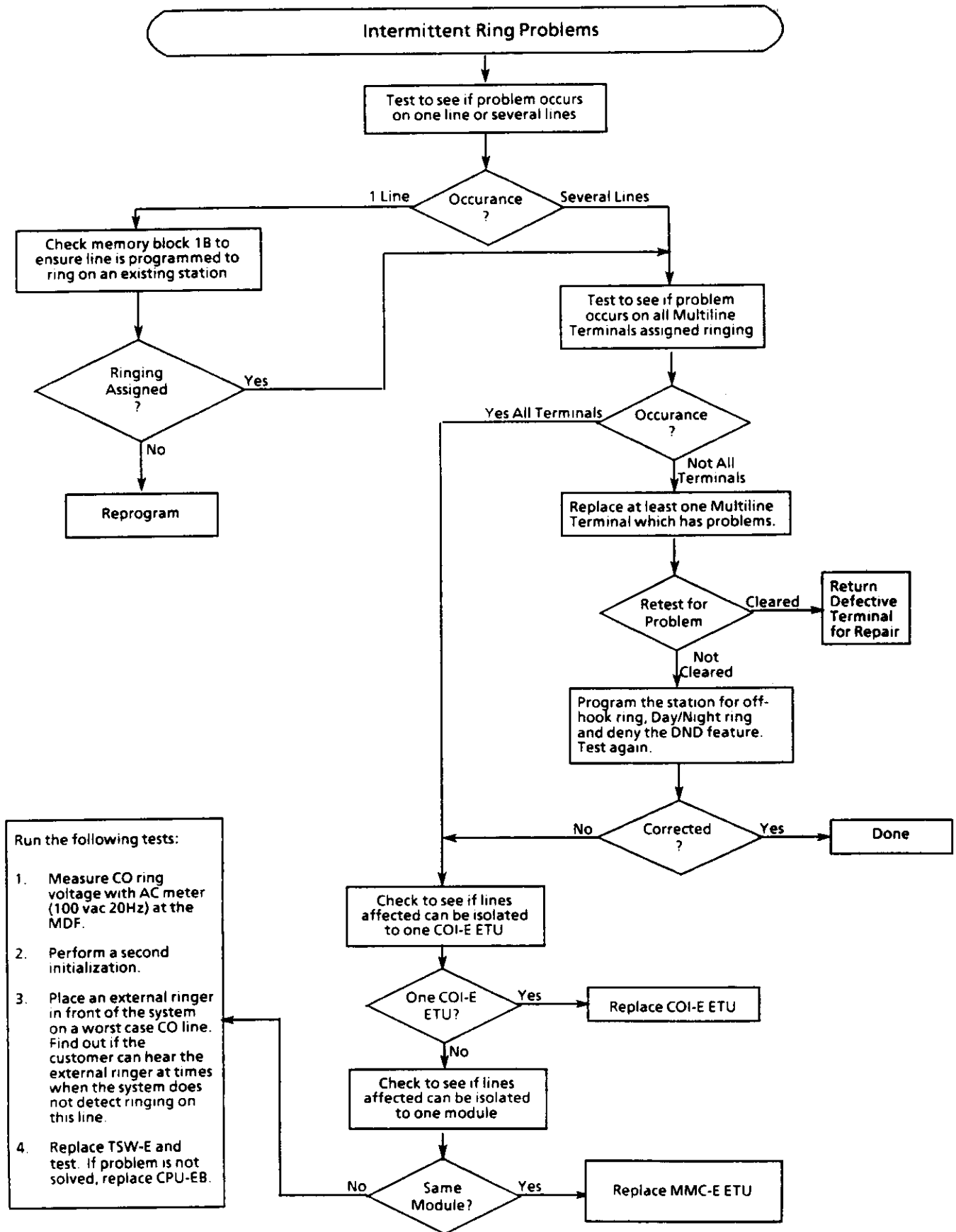

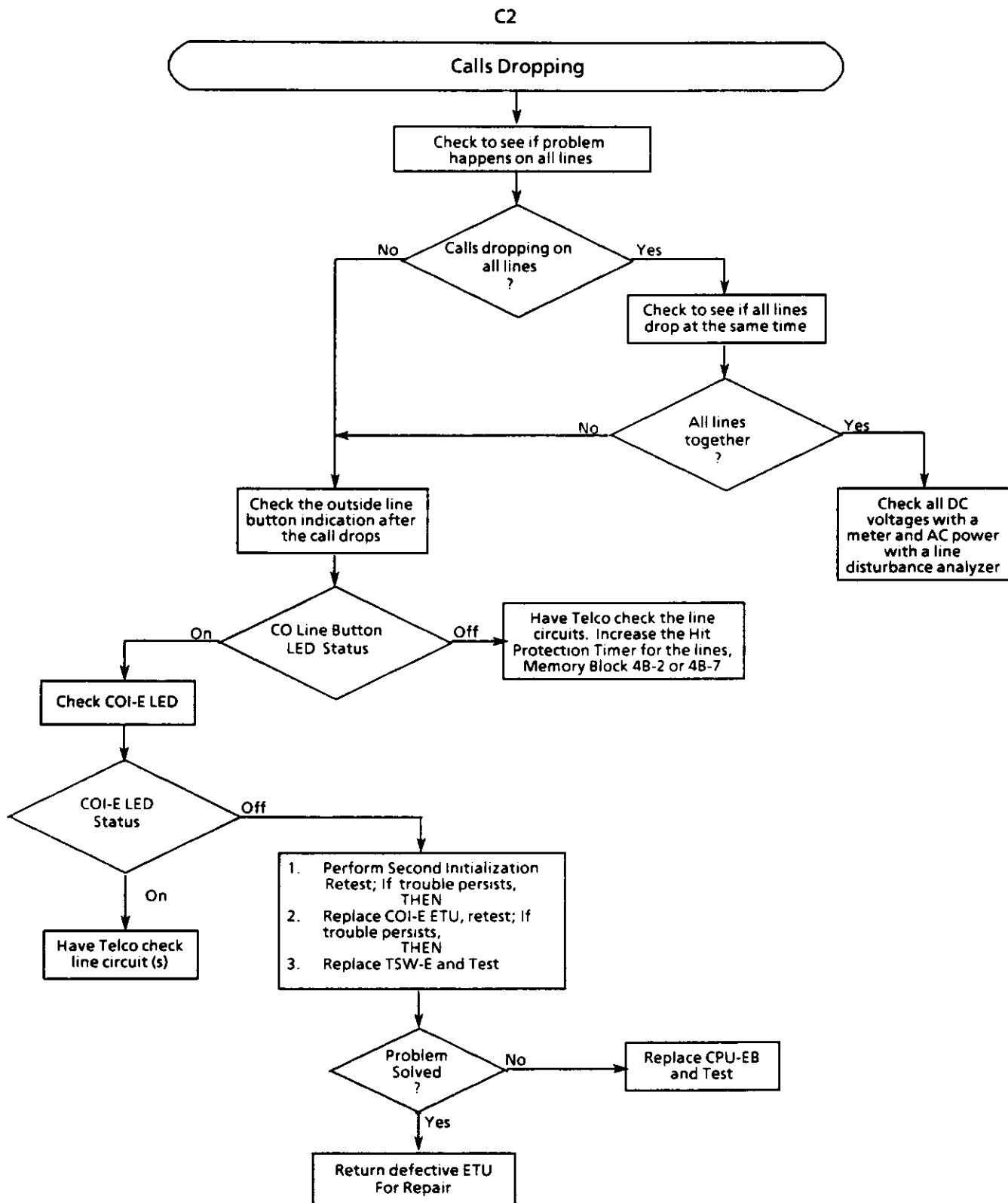

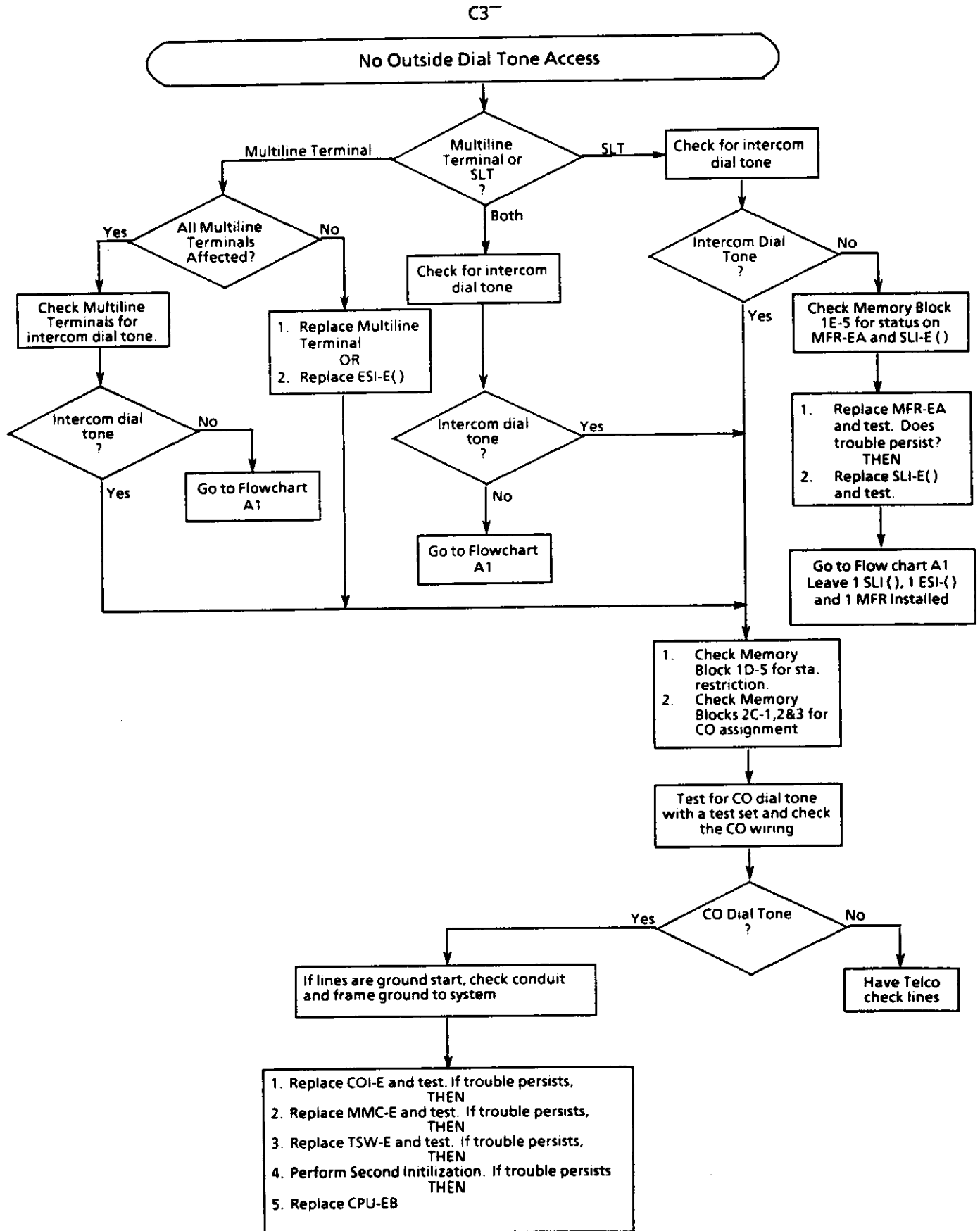

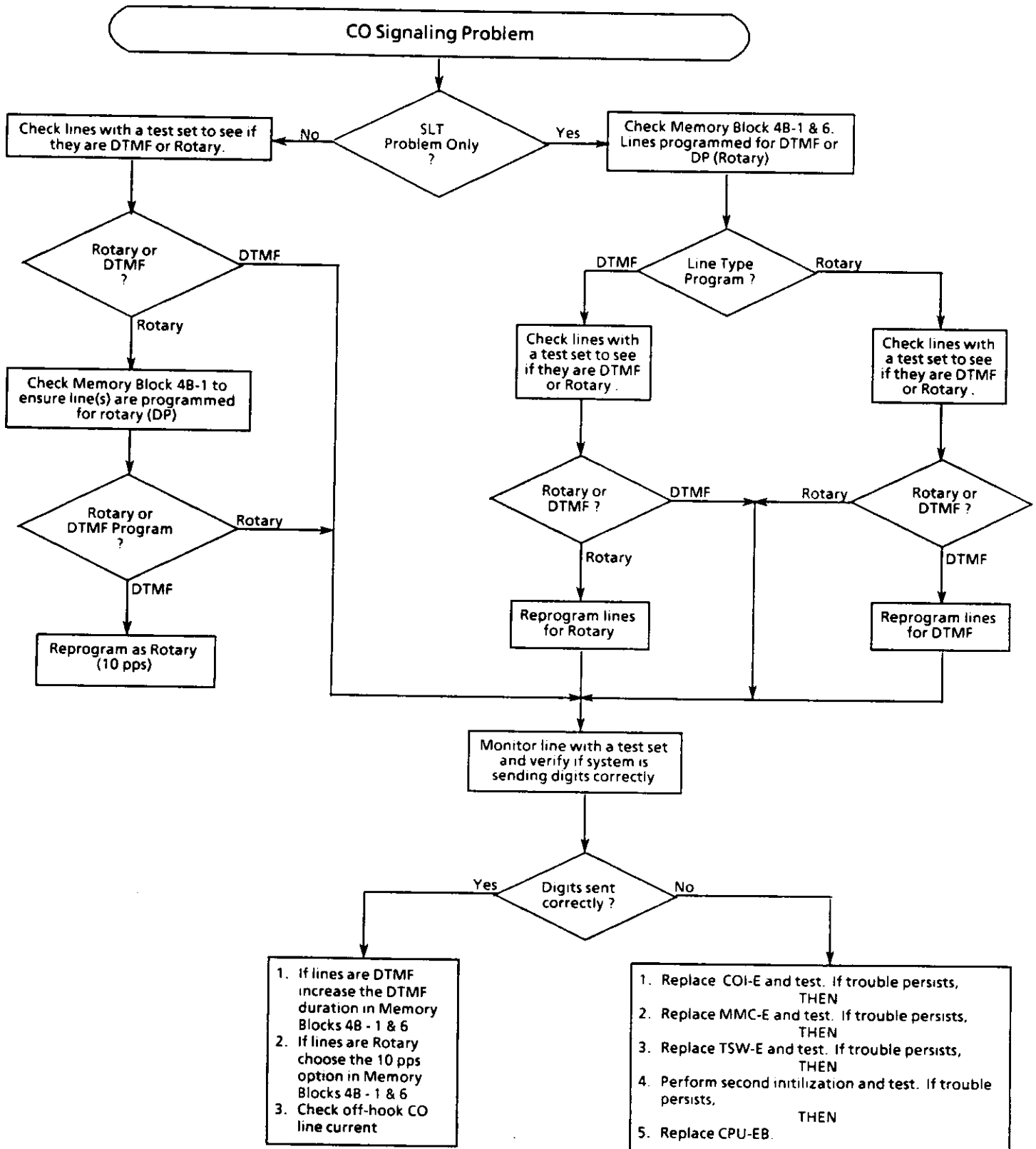

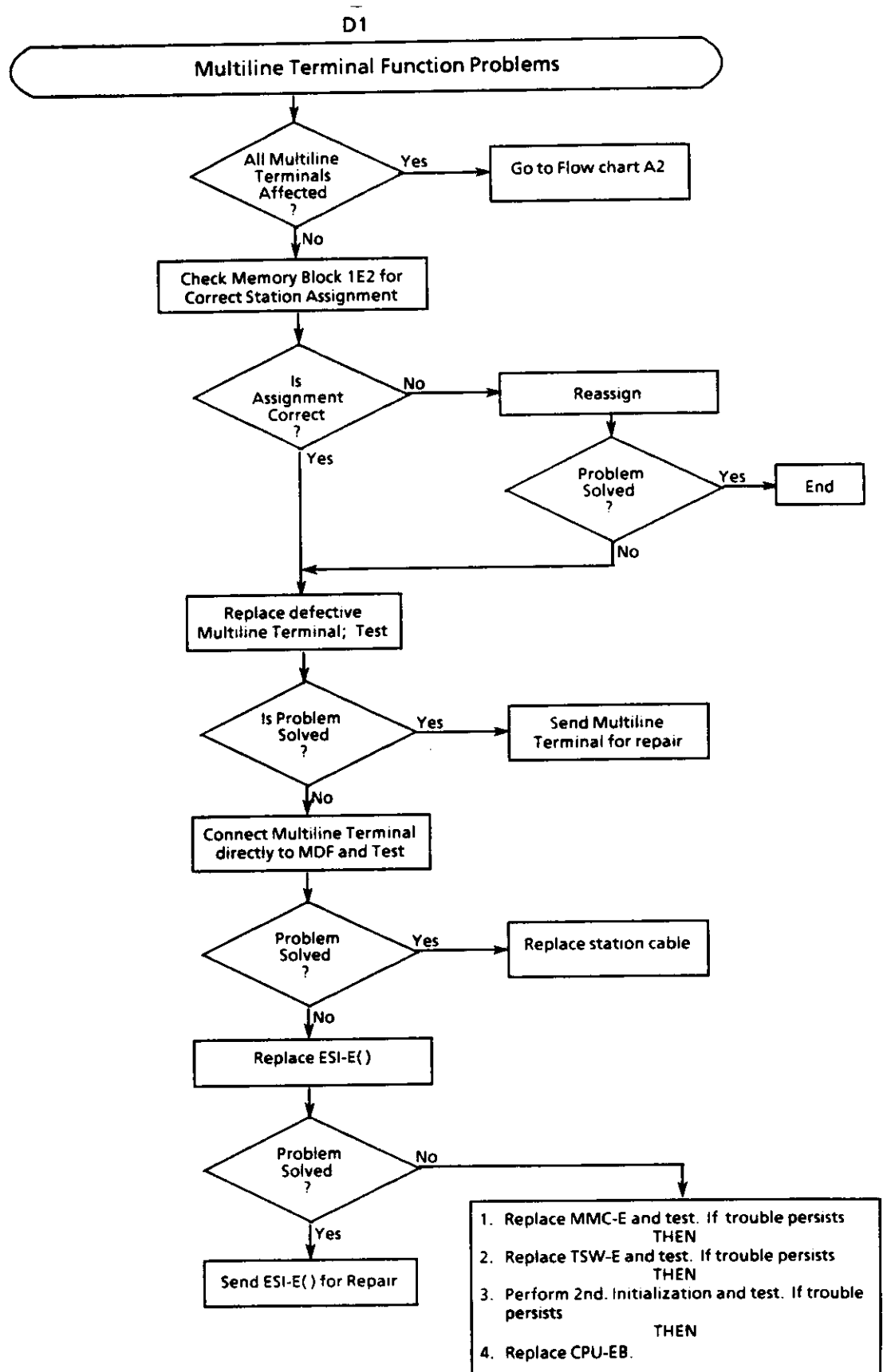

D2

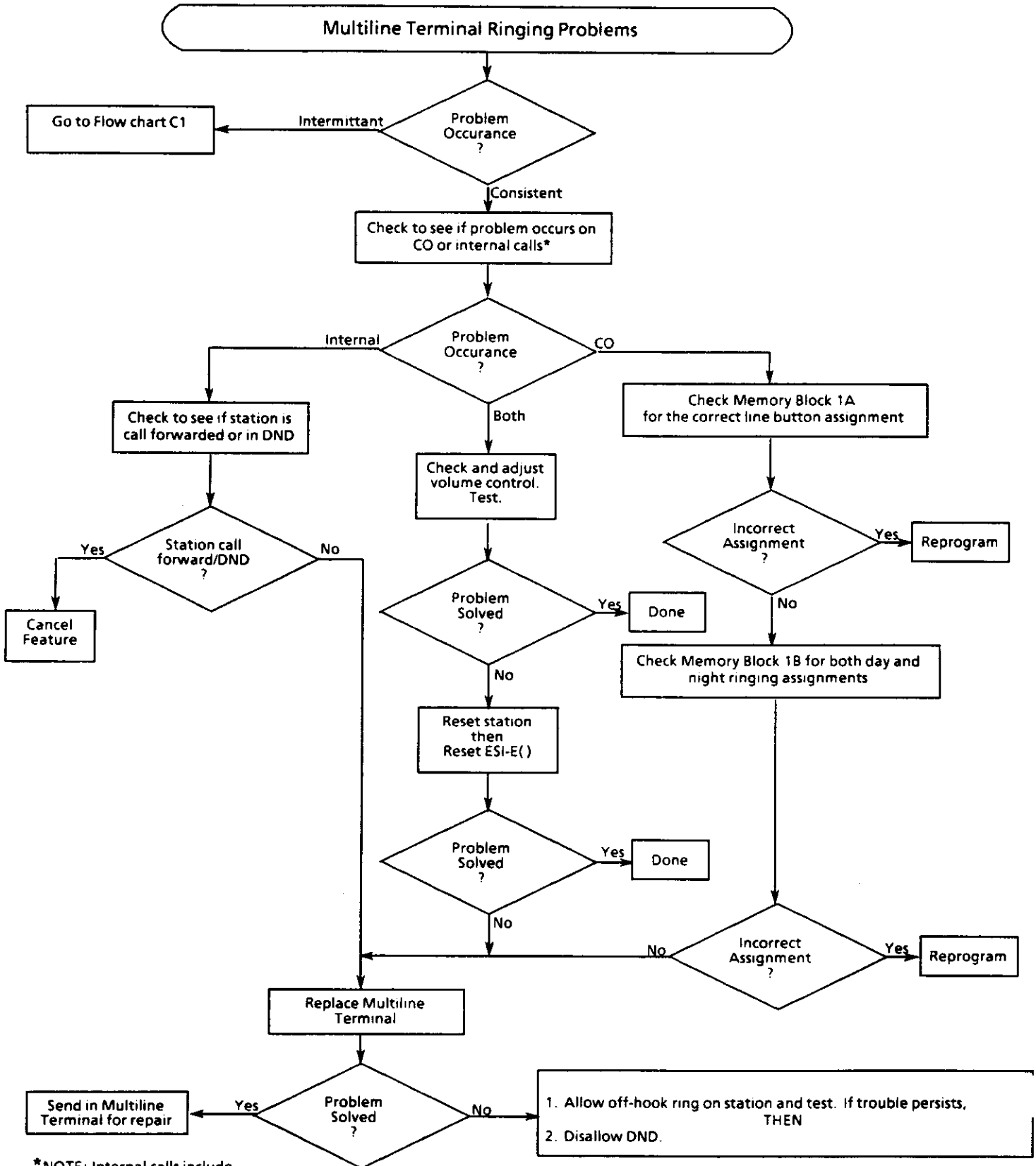

\*NOTE: Internal calls include station to station as well as transferred calls.



D3

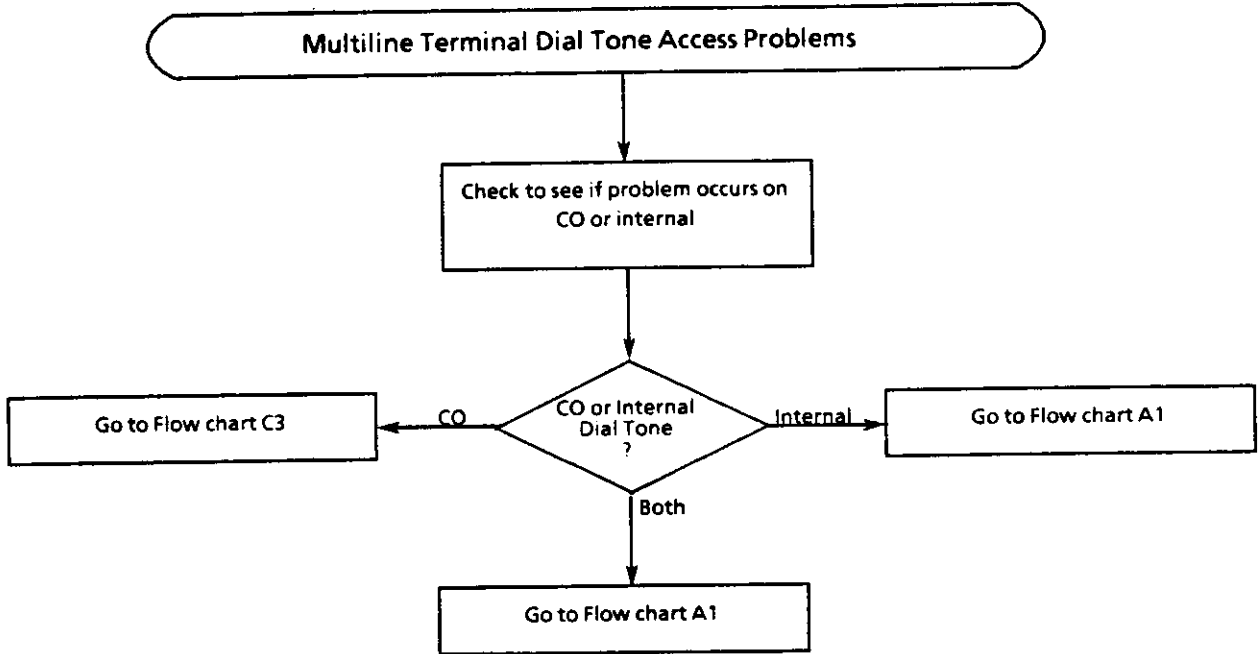

E1

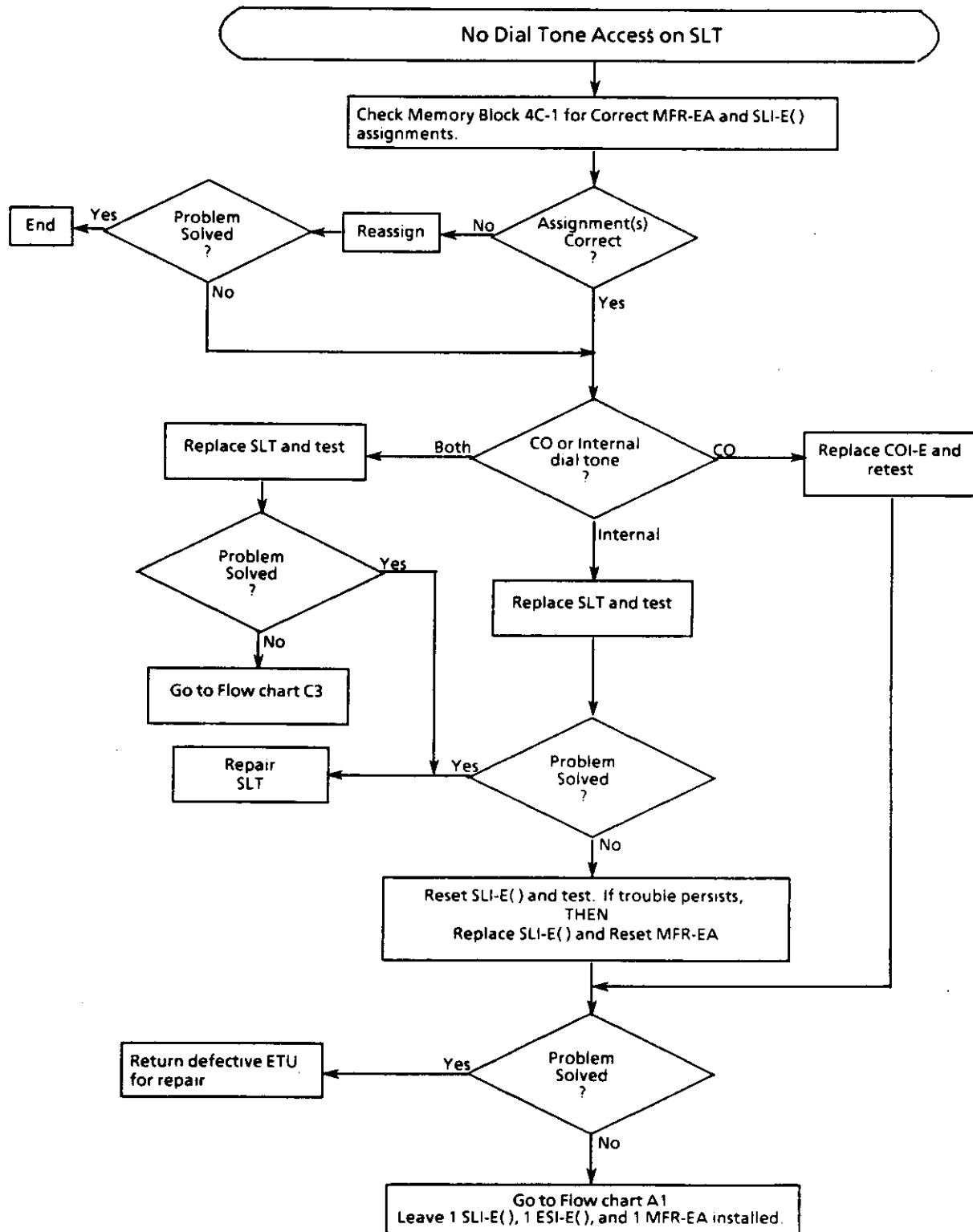

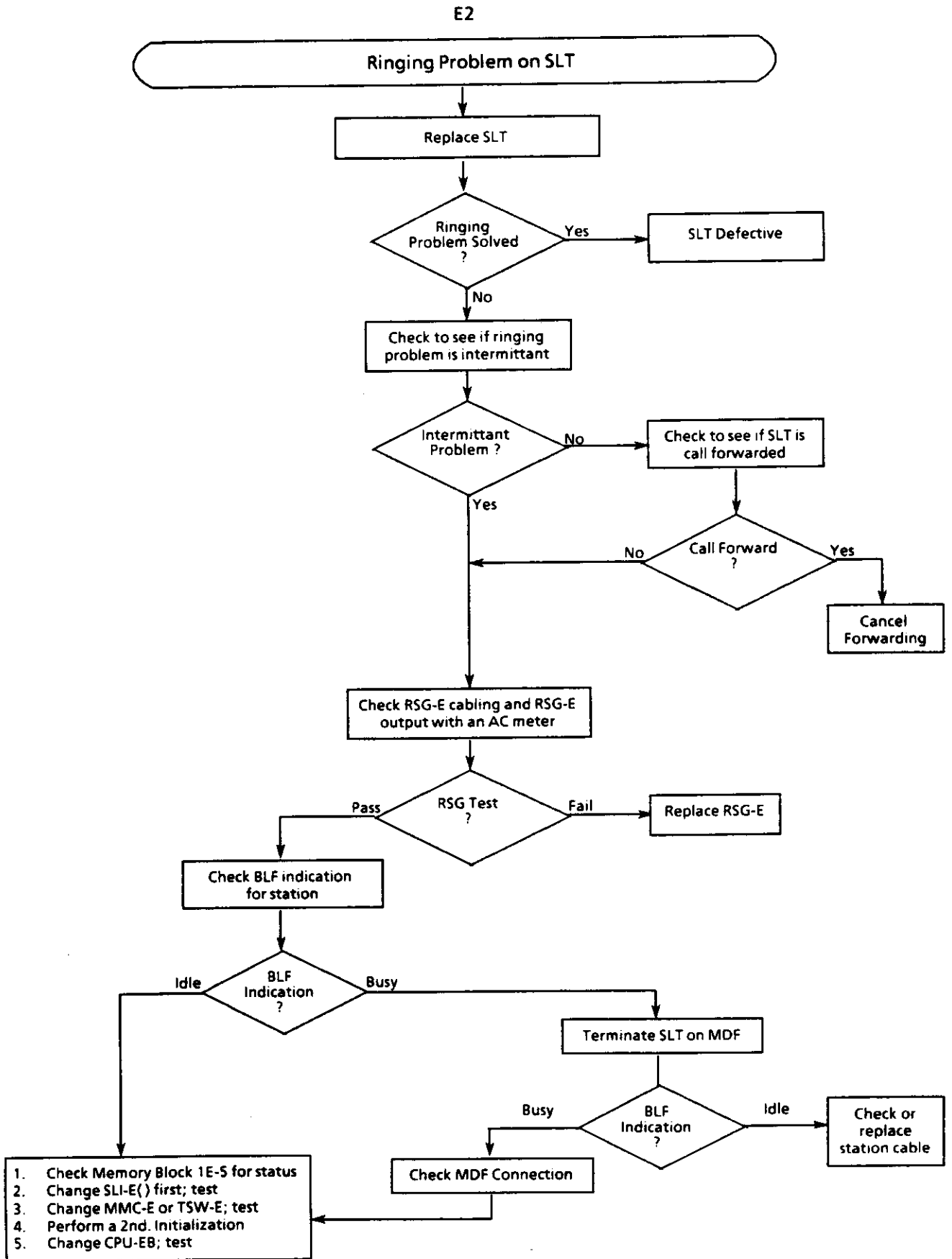

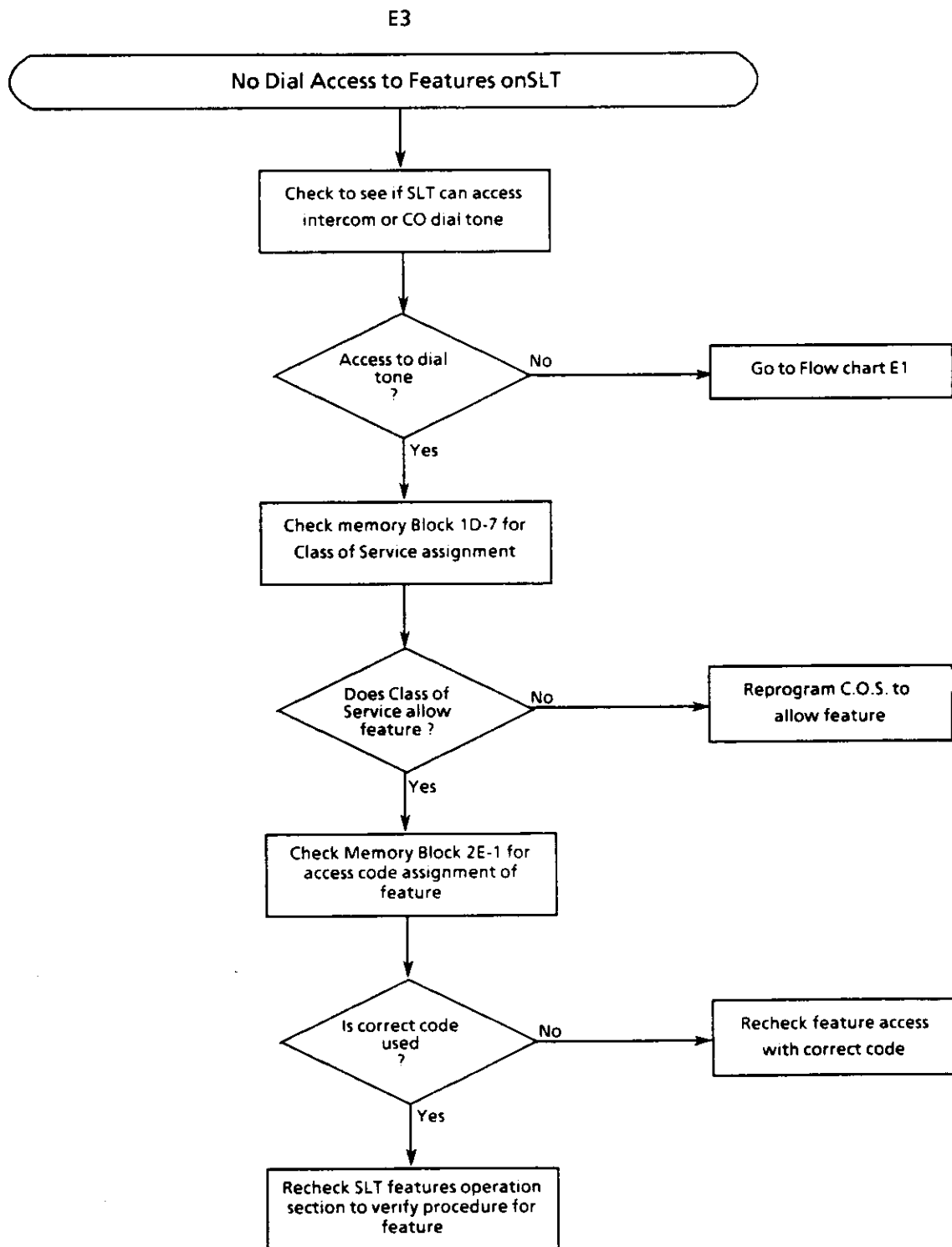

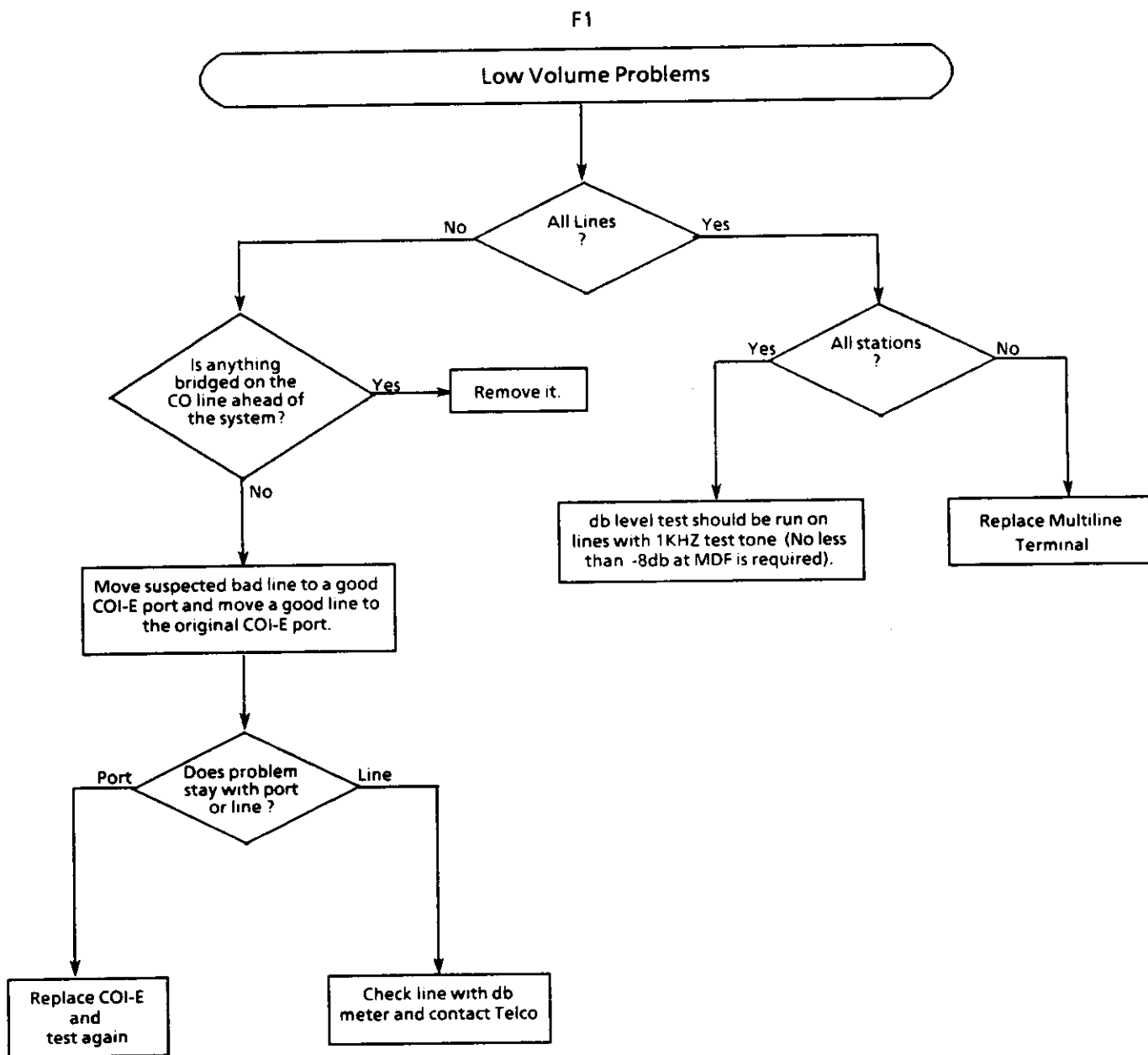

G1

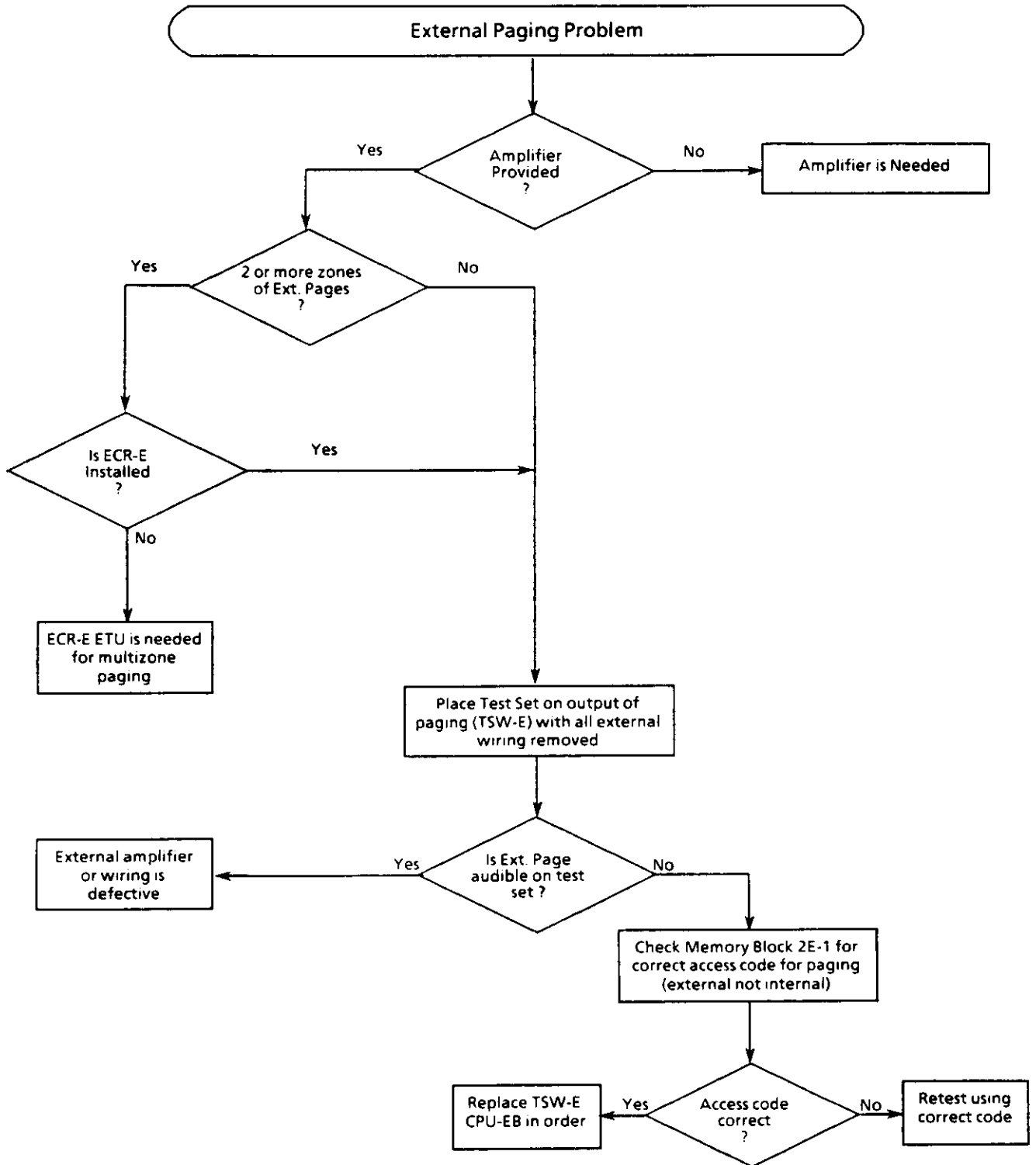

H1

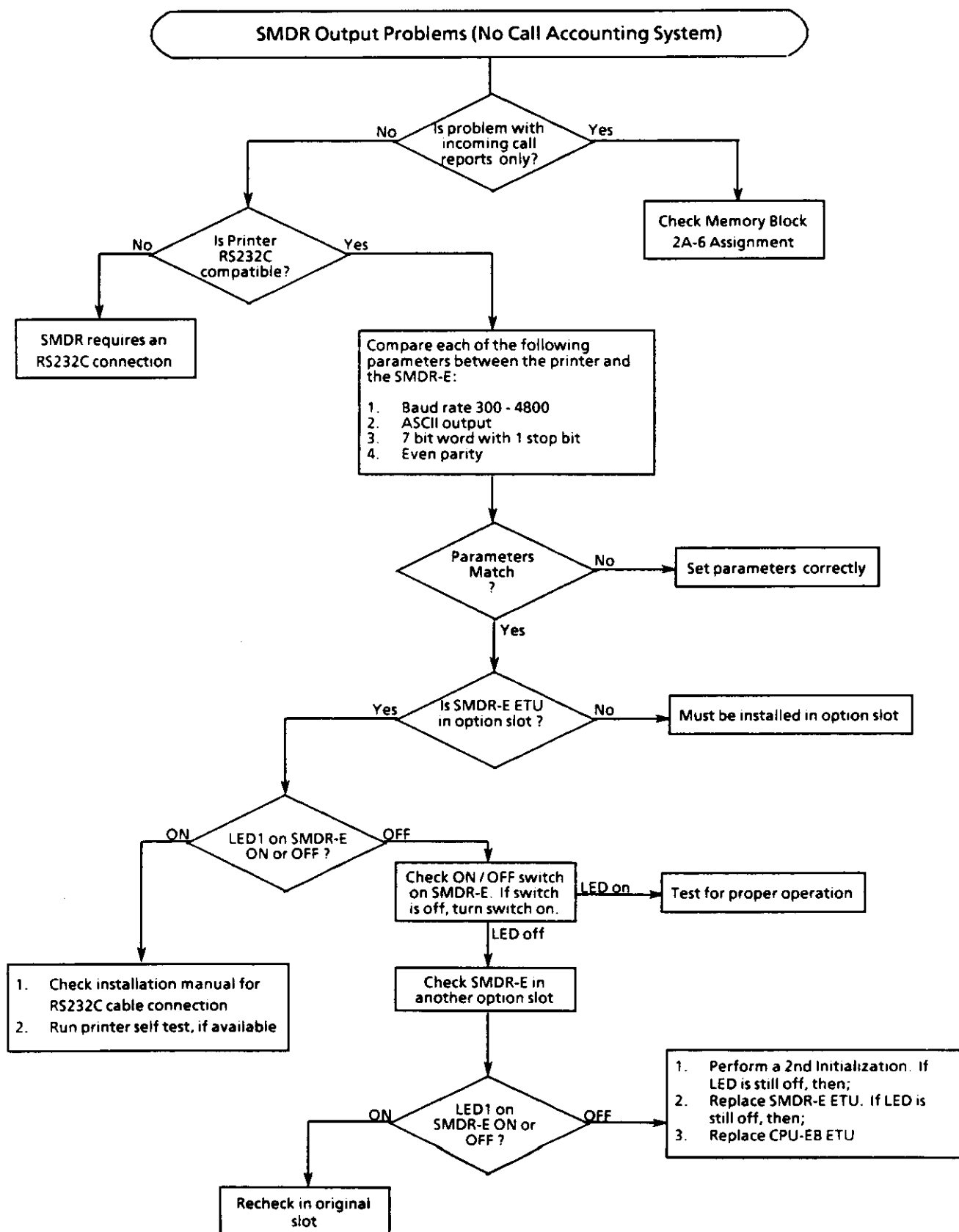





**CHAPTER 7**  
**LEAST COST ROUTING**  
**(LCR)**



## CHAPTER 7 LEAST COST ROUTING (LCR)

### TABLE OF CONTENTS

SECTION DESCRIPTION	PAGE	770.6 Office Code Tables	700-70
710 GENERAL	700-1	770.7 Extra Code Tables and Home NPA	700-72
<b>720 EQUIPMENT IDENTIFICATION</b>			<b>SECTION 710 GENERAL</b>
720.1 General	700-1	The Least Cost Routing (LCR) feature is used by the system to select the most economical route (line) when originating outside calls.	
720.2 LCR-E ETU	700-1	The Electra MarkII provides this feature as an option and requires the installation of an LCR-E ETU. Additionally, a portable computer PC-8201A or PC-8300 manufactured by NEC Corporation is required to program the LCR feature.	
720.3 Portable Computer PC-8300	700-2	The LCR feature provided with the Electra MarkII Digital Telephone System can select lines, such as FX (Foreign Exchange), SCC (Specialized Common Carrier), Outward WATS (Wide Area Telecommunications Service), DDD (Direct Distance Dial), and Tie lines. LCR routes the calls choosing the least expensive route, based on the number dialed, the time of day, and the day of the week, as previously programmed in the LCR package.	
<b>730 INSTALLATION OF LCR-E ETU</b>		LCR cannot access CCSA (Common Control Switching Arrangement) lines or incoming-only lines such as DID (Direct Inward Dial) or Inward WATS lines. In addition, the LCR feature cannot be used to make operator, credit card, international, or uniform dialing calls. Manually selecting a trunk defeats LCR.	
730.1 General	700-4	<b>SECTION 720 EQUIPMENT IDENTIFICATION</b>	
730.2 Installation of LCR-E ETU	700-4	<b>720.1 GENERAL</b>	
730.3 Switch SW1 Setting	700-4	The LCR-E ETU is an option within the Electra MarkII system, but equipment such as the portable computer, PC-8300, which is required for programming, must be locally provided.	
730.4 Switch DIP1 Setting	700-4	<b>720.2 LCR-E ETU</b>	
730.5 Switch SW2 Setting	700-5	The LCR-E ETU is the Least Cost Routing Unit that consists of an 8 bit microprocessor, a 256K ROM chip, a 256K RAM chip, clock generator circuit, RS-232C interface and common memory circuit.	
730.6 Routing the RS-232C Cable	700-5	The LCR-E contains three switches, an LED and an RS232C connector ended ribbon cable. See Figure 720-1.	
730.7 Removing the Access Panel	700-5	Switch 1, designated SW1, is used to connect backup battery to the LCR-E memory. This switch should be	
730.8 Mounting the RS-232C Connector	700-5		
730.9 Verifying SW2 Setting	700-5		
<b>740 INSTALLATION OF PC-8300</b>			
740.1 General	700-5		
740.2 AC Power Adapter	700-6		
740.3 Battery Backup	700-6		
740.4 Floppy Disk Unit PC-8231A Connection	700-6		
740.5 Printer Connection	700-7		
740.6 PC-8300 Connection To LCR-E ETU	700-7		
<b>750 PROGRAMMING</b>			
750.1 General	700-7		
750.2 How To Use This Section	700-7		
750.3 Programming System NPM for LCR	700-8		
750.4 LCR Programming Construction	700-11		
750.5 Initializing the PC-8300	700-14		
750.6 Programming the LCR-E ETU	700-16		
750.7 Input of Data	700-25		
750.8 Explanation of LCR Commands	700-29		
750.9 Error Messages	700-52		
<b>760 ALGORITHMS</b>			
760.1 CPU Processing for LCR	700-54		
760.2 LCR Processing	700-55		
<b>770 JOB SPEC SAMPLES</b>			
770.1 Area Code Tables	700-59		
770.2 Weekly Schedule Tables	700-62		
770.3 Daily Schedule Tables	700-64		
770.4 Route Advance Tables	700-66		
770.5 Route Tables	700-68		

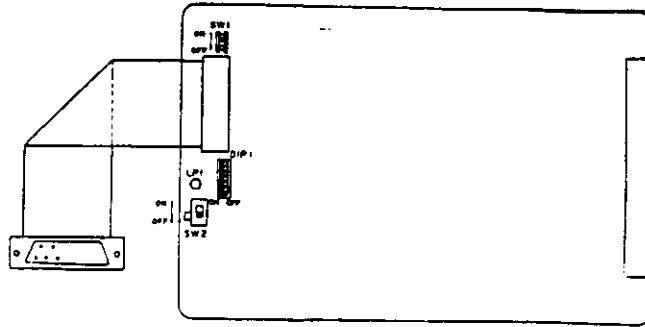

Figure 720-1 LCR-E ETU Switch/LED Layout

set to the ON position to allow memory retention during power failure or brownout conditions.

Switch 2, designated SW2 is used to busy in/out from the LCR-E ETU allowing the ETU to be removed or inserted without powering down the system.

The DIP1 switch is a 7 position dip switch used to select a baud rate in the range of 150-9600. This switch should normally be set to 4800 baud. See Figure 720-2.

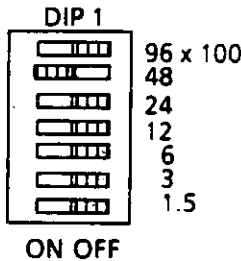

Figure 720-2 DIP 1 Baud Rate Switch

LED (green) lights in conjunction with SW2 being in the ON position, indicating that the LCR-E ETU is receiving power.

A 25 pin RS-232C connector ended ribbon cable is provided to connect the PC-8300 portable computer, which is used to enter data into the LCR-E ETU memory.

A maximum of one LCR-E ETU can be installed in a system, into either OP1, OP2, or OP3 slots of any CCU.

### 720.3 PORTABLE COMPUTER PC-8300

#### 1. General

The Electra MarkII Digital Telephone System uses the PC-8300 to program the LCR-E ETU.

#### 2. Specifications

For PC-8300 specifications, refer to the operations manual provided with the PC-8300.

#### 3. Equipment Required

The following equipment is required to install, program and maintain the LCR-E ETU.

- a. PC-8300
- b. Floppy Disk Drive Unit PC-8231A
- c. PC-8298A FDD Cable (included with the PC-8231A Floppy Disk Drive unit)
- d. RS-232C Cable PC-8495A-01
- e. Parallel Printer Cable PC-8494A or (PC-8294A)
- f. LCR Floppy Disk (3.5 inches) (provided with LCR-E ETU)
- g. Parallel Interface Printer

**NOTE:** The PC-8201A requires six 8k RAM ICs installed. The RAM ICs are PC-8201A-06.

- Items a ~ e can be obtained from an NEC Home Electronics distributor.
- Item f is provided from NEC America, Inc.
- Item g must be locally provided.

#### 4. Equipment Configuration

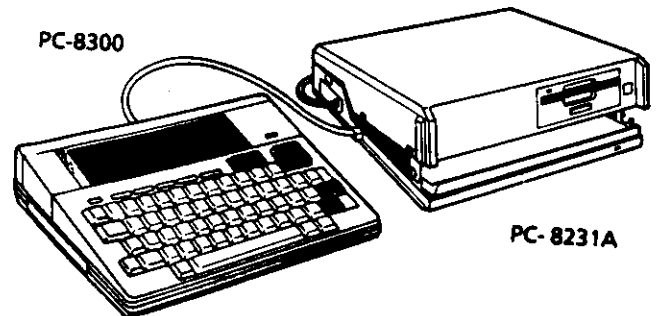

Figure 720-3 PC-8300 Configuration

#### 5. Equipment Description

- a. PC-8300

The PC-8300 consists of the following:

- CPU, ROM, RAM section
- Key Board
- 8 line x 40 digit LCD
- Printer Interface
- Floppy Disk Drive Interface
- RS-232C Interface
- Telephone Interface
- Bar Code Reader Interface
- Data Recorder Interface

The PC-8300 requires a floppy disk unit (PC-8231A) to program and maintain the LCR-E ETU.

It also requires an RS-232C cable for the connection of the LCR-E ETU to the PC-8300.

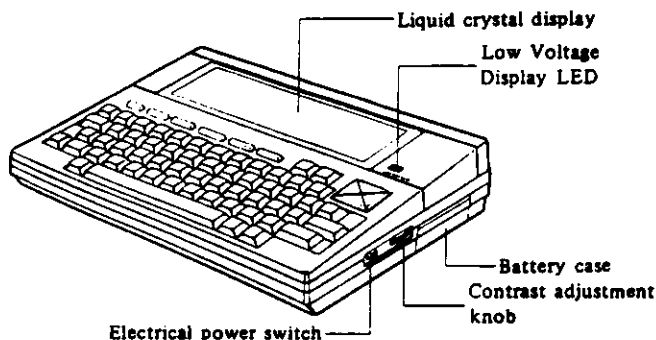

Figure 720-4 Outside View of PC-8300

b. Floppy Disk Unit PC-8231A  
The floppy disk unit, PC-8231A, is connected to the PC-8300 using a floppy disk cable (included with the PC-8231A). The PC-8231A accommodates a 3.5 inch floppy disk used to enter and store LCR data. See Figure 720-3.

c. RS-232C Cable PC-8495A-01  
The RS-232C cable (PC-8495A-01) is used to connect the PC-8300 to the LCR-E ETU.

One end of the RS-232C cable is connected to the RS-232C connector located on the rear panel of the PC-8300. The other end of the cable is connected to the RS-232C connector provided with the LCR-E ETU. See Figures 720-5~720-7.

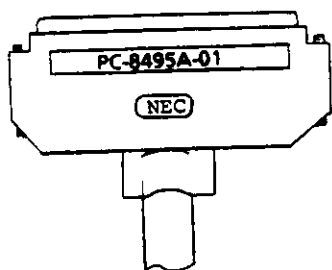

Figure 720-5 Outside View of RS-232C Cable PC-8495A-01

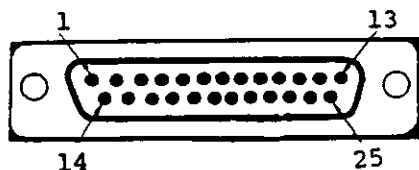

Figure 720-6 Connector Pin Configuration

PIN NO.	SIGNAL	PIN NO.	REMARKS
1	GND	1	Protective Ground
2	TxD	2	Transmit Data
3	RxD	3	Receive Data
4	RTS	4	Request to Send
5	CTS	5	Clear to Send
6	DSR	6	Data Set Ready
7	SG	7	Signal Ground
8	DCD	8	Data Carrier Detect
20	OTR	20	Data Terminal Ready
22	RI	22	Ring Indicator

OTHER PINS ARE NOT CONNECTED.

Figure 720-7 Connector Wiring Connection

d. Printer Cable PC-8494A (or PC-8294A)  
This printer cable is used for connecting a printer to the PC-8300.

The 26 pin (female) end is connected to the PRINTER connector located on the rear panel of the PC-8300. The 36 pin (male) end is connected to the connector provided on the printer. See Figures 720-8, 720-9, and Table 720-1.

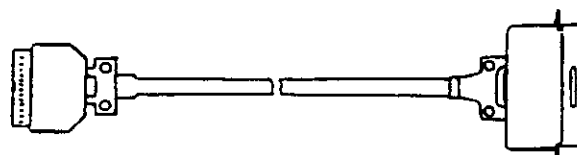

Figure 720-8 Outside View of Printer Cable PC-8494A (or PC-8294A)

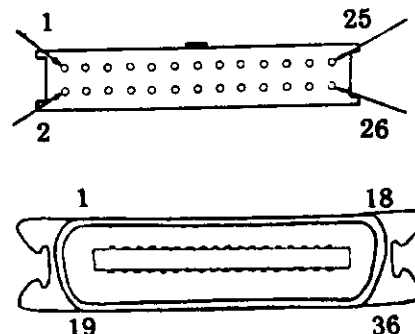

Figure 720-9 Connector Pin Configuration

e. Floppy Disk (3.5 inches)  
The floppy disk is used for programming and maintenance of the LCR data.

The LCR programming software and LCR data is stored in this floppy disk.

Table 720-1 Connector Wiring Connection

CONNECTOR (Centronics Parallel)	26 PIN CONNECTOR (8201A)	FUNCTION
1	1	DATA STROBE
2	3	Parallel Data 0
3	5	1
4	7	2
5	9	3
6	11	4
7	13	5
8	15	6
9	17	7
10	--	--
11	21	Printer Busy
12	--	--
13	25	Printer Select
14	--	--
15	--	--
16	--	--
17	--	--
18	--	--
19	6	Signal Ground
20	--	--
21 ~ 26	--	--
27	--	--
28	4	Signal Ground
29	--	--
30	2	Signal Ground
31 ~ 36	--	--

f. Parallel Interface Printer  
 Any parallel interface printer that conforms with the Centronics® Standard can be connected to the PC-8300.

A printer is used to provide a printed copy for verifying and checking the programmed LCR data.

### SECTION 730 INSTALLATION OF LCR-E ETU

#### 730.1 GENERAL

This section provides a complete and comprehensive understanding of the proper installation of the LCR-E ETU and the portable computer PC-8300. It is recommended that this section be read in its entirety to familiarize yourself with its content to enable a faster, more productive installation. The LCR-E ETU makes extensive use of CMOS technology. Special care must be taken to avoid any static discharge to the LCR-E ETU.

#### 730.2 INSTALLATION OF THE LCR-E ETU

The LCR-E ETU is installed in the OP1, OP2, OP3, or dual purpose card slot of any CCU. The component side of the LCR-E ETU must face to the right side as viewed from the front of the CCU as shown in Figure 730-1.

#### 730.3 SWITCH SW1 SETTING

Prior to installation, ensure that SW1 is set to the ON position. See Figure 720-1 and Figure 730-2.

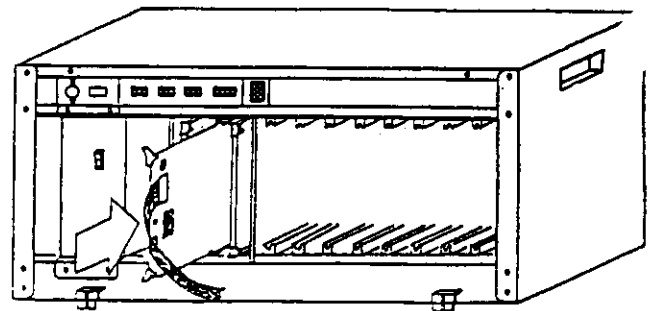

Figure 730-1 Installing the LCR-E ETU



Figure 730-2 Battery Backup Switch SW1

#### 730.4 SWITCH DIP1 SETTING

Set switch DIP1 to the proper position for the baud rate. (Switch DIP1 is normally set at a baud rate of 4800). See Figure 720-1 and Figure 730-3.

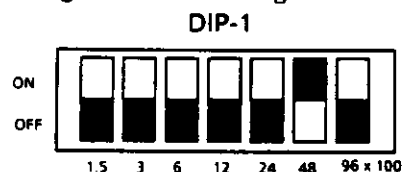

Figure 730-3 Switch DIP-1 For Baud Rate

### 730.5 SWITCH SW2 SETTING

When installing the LCR-E ETU, turn SW2 to the OFF position. This will allow the insertion or removal of the LCR-E ETU into the slot without powering down the CCU. After installing the LCR-E ETU in the CCU, turn SW2 to the ON position.

When the LCR-E ETU is installed without power applied to the CCU, SW2 must be set to the ON position before applying power to the CCU. See Figure 720-1 and Figure 730-4.

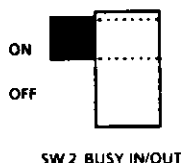

Figure 730-4 Busy In/Out Switch SW2

### 730.6 ROUTING THE RS-232C CABLE

Route the RS-232C connector ended cable down and to the right side of the CCU to avoid any interference with the insertion and removal of other ETUs. See Figure 720-1 and Figure 730-1.

### 730.7 REMOVING THE ACCESS PANEL

Locate the access panel (the longer of the two) located on the right side of the CCU as viewed from the front of the CCU. Loosen the screw, then lift up and remove the panel. See Figure 730-5.

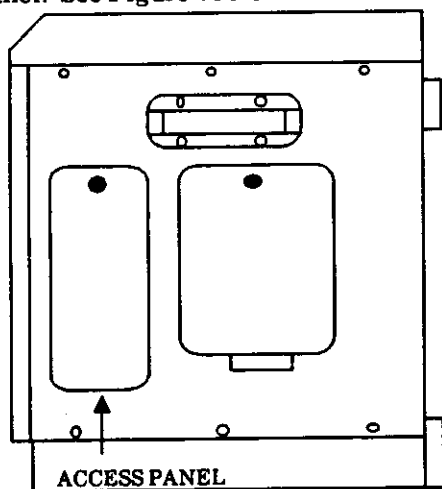

Figure 730-5 Right Side View of CCU

### 730.8 MOUNTING THE RS-232C CONNECTOR

Mount the RS-232C connector, in one of the openings made accessible after removing the access panel, with screws and nuts (locally provided). See Figure 730-6.

### 730.9 VERIFYING SW2 SETTING

If the LCR-E ETU was installed with power applied to the CCU, verify that SW2 switch is set to the ON position (if required, turn ON).

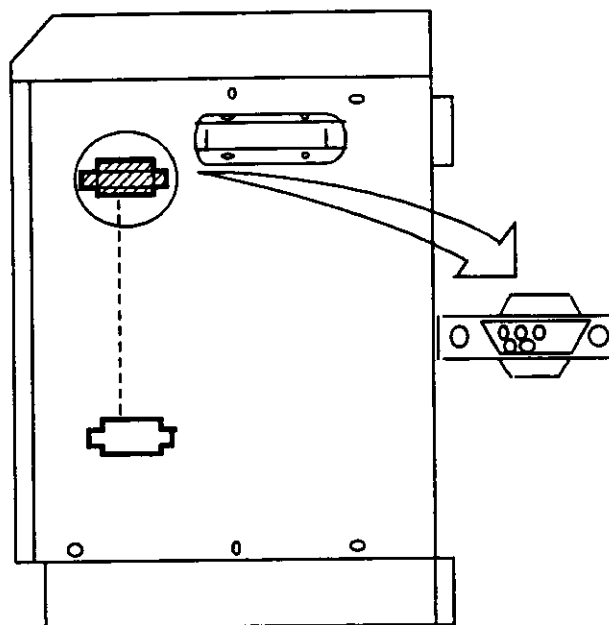

Figure 730-6 Mounting the RS-232C Connector

## SECTION 740 INSTALLATION OF PC-8300

### 740.1 GENERAL

The PC-8300 is powered by four AA size (1.5 volt) batteries. An optional NiCad (nickel-cadmium) Battery Pack (PC-8201-90) is also available for use in place of the regular battery pack.

In addition, there is also a backup system which consists of internal NiCad batteries which automatically switches on for emergency use. These batteries charge continuously whenever the computer is in normal operation.

While the PC-8300 is in a storage condition, the backup batteries can maintain the contents of the RAM for up to 30 days, depending upon the amount of RAM installed. Keep in mind that these batteries cannot actively operate the PC-8300 for very long.

If the main batteries have a low charge, causing the backup battery system to be used, the LOW BATTERY LED indicator on the PC-8300 will light up. The batteries should be changed when this indicator lights up, since the PC-8300 can only be operated for approximately 20 minutes from this point. Storing the PC-8300 for a long time with a low charge will cause it to become inoperable.

**NOTES:** 1. If the PC-8300 is operated with the Low Battery Indicator lit up for more than 20 minutes, the unit will become inoperable and all the data stored in RAM will be lost.

2. Batteries should be replaced as soon as possible after the LOW BATTERY LED lights up. The power switch should always be turned OFF during change of batteries.

**740.2 AC POWER ADAPTER**

The AC power adapter (PC-8271A-01) converts 120 volts AC to 8.5 volts DC, which is used to operate the PC-8300. This may be used when an outlet is available in order to prolong the life of the batteries.

**NOTES:** 1. When connecting the AC power adapter to the PC-8300 ALWAYS plug the adapter into the wall outlet before connecting it to the unit. For disconnection, the adapter should be unplugged from the PC-8300 first.

2. Be certain that only the PC-8271A-01 is used. Damage to the PC-8300 personal computer may be caused by the use of any other adapter.

3. Before connecting the AC power adapter to the PC-8300, make sure to turn the computer and all the peripherals OFF.

**740.3 BATTERY BACKUP**

1. Make sure the power switch located on the right side of the PC-8300 is set to the OFF position. See Figure 740-1.

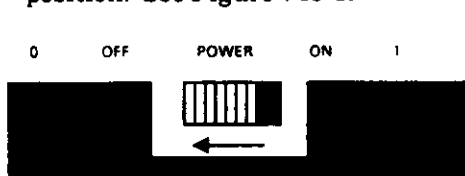

Figure 740-1 PC-8300 Power Switch

2. Remove the cover of the battery compartment. See Figure 740-2.

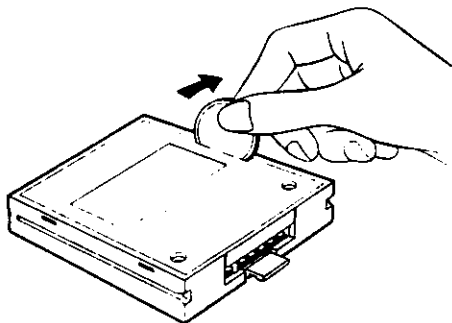

Figure 740-2 PC-8300 Battery Compartment Cover

3. Install four AA size dry batteries in the battery compartment. See Figure 740-3.  
 4. Replace the cover of the battery compartment.

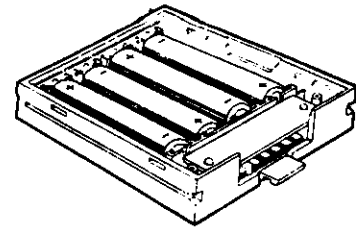

Figure 740-3 PC-8300 Battery Installation

5. Turn ON the battery backup switch located on the bottom of the PC-8300. See Figure 740-4.

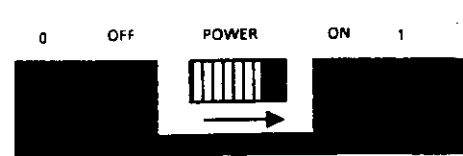

Figure 740-4 PC-8300 Battery Backup Switch

**NOTES:** 1. As outlined in the section on batteries, the backup power source consists of internal nickel-cadmium batteries. The Backup Power switch located on the bottom of the PC-8300 must be in the ON position for the computer to operate.

2. If the PC-8300 is stored and is unused for more than 30 days, the backup power switch should be set to OFF to prevent the total discharge of the batteries and deterioration in performance.

**740.4 FLOPPY DISK UNIT PC-8231A CONNECTION**

1. Power to the micro floppy disk unit is supplied by an AC pack (included) or by the optional battery pack. When using the unit in the home or office, AC power can be obtained by inserting the AC pack as shown. Insert the AC pack into the device until it clicks, thus making sure that it will not pop out during use. The inlet is usually covered by a sliding cover.

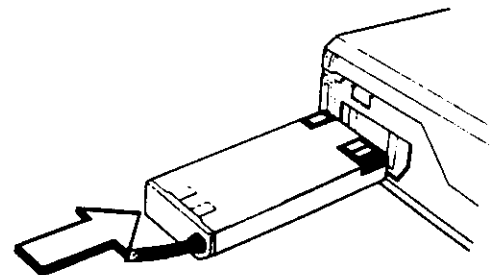

Figure 740-5 Inserting the AC Power Pack

2. The lid of the PC-8231A is opened by the slide lock buttons on the left and right side of the unit. Place your hands on both of these buttons and lift



place your hands on both of these buttons and lift the top half of the unit while pulling these slide-lock buttons. Raise the front side of the unit approximately 5cm and the lid will automatically open and the front side of the unit will slowly come down. The lid will support the disk unit in the open position.

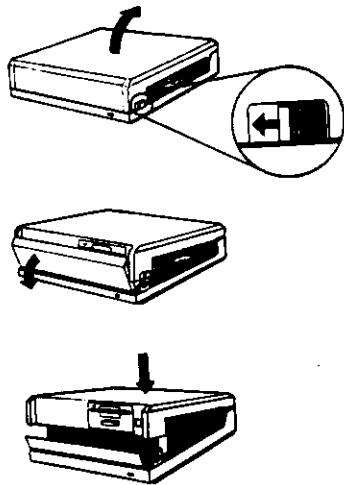

Figure 740-6 Opening the PC-8231A Lid

3. Locate the PC-8300 and the floppy disk unit (PC-8231A) near each other. See Figure 740-7.

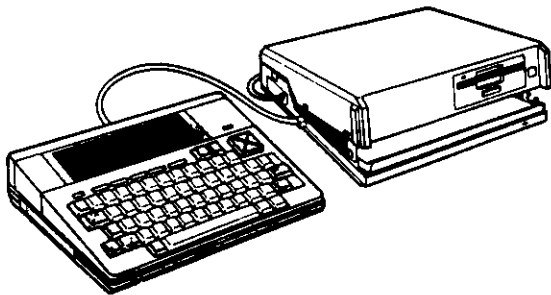

Figure 740-7 Locating Floppy Disk Unit PC-8231A

4. Connect one side of the 8-pin floppy disk cable to the FDD interface on the rear panel of the PC-8300. See Figure 740-8.
5. Connect the end with the ferrite toroid to the floppy disk unit PC-8231A. See Figure 740-7.

#### 740.5 PRINTER CONNECTION

1. Locate the PC-8300 and the printer near each other. See Figure 740-8.

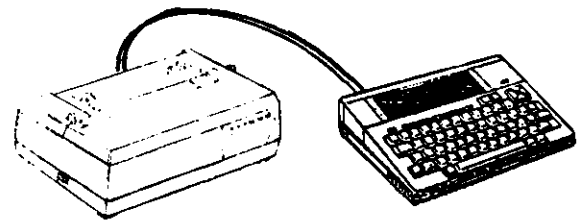

Figure 740-8 Locating Printer

2. Connect the 26 pin connector (female) of the printer cable PC-8494A (or PC-8294) to the PRINTER interface on the rear panel of the PC-8300.
3. Connect the 36 pin connector (male) of the printer cable to the parallel input connector of the printer.

#### 740.6 PC-8300 CONNECTION TO LCR-E ETU

1. Connect one end of the RS-232C cable PC-8495A-01 to the RS-232C interface on the rear panel of the PC-8300.
2. Connect the other end of the RS-232C cable to the RS-232C connector of the LCR-E ETU which was previously mounted on the right side of the CCU in paragraph 730.8.

## SECTION 750 PROGRAMMING

### 750.1 GENERAL

This section is intended to provide the user with a complete understanding of how to program the LCR subsystem. It is strongly recommended that this section be read in its entirety BEFORE attempting the actual programming. This will allow for faster and more efficient programming.

### 750.2 HOW TO USE THIS SECTION

The remainder of the programming section (Section 750) is divided into the following subsections:

PROGRAMMING SYSTEM NPM FOR LCR (Section 750.3) describes in detail, the related programming areas within the system memory blocks which are required to properly implement the LCR feature.

LCR PROGRAMMING CONSTRUCTION (Section 750.4) provides a basic description of how the LCR subsystem is configured within the Electra MarkII Digital Telephone system, and provides an explanation of the various parameters of the LCR data programming.

INITIALIZING THE PC-8300 (Section 750.5) explains how to initialize the PC-8300 portable computer in preparation for LCR programming and how to set it up to allow the automatic execution of the LCR data program upon power up of the PC-8300.

PROGRAMMING LCR DATA (Section 750.6) explains how data is entered into the LCR program via the PC-8300.

INPUT OF DATA (Section 750.7) explains the general flow of programming and provides detailed examples on how the various sections of the program are accessed.

EXPLANATION OF LCR COMMANDS (Section 750.8) describe each command and gives examples of their use.

ERROR MESSAGES (Section 750.9) explains the various possible error messages as well as the reasons why they occur and possible solutions for each of them.

### 750.3 PROGRAMMING SYSTEM NPM FOR LCR

#### 1. Programming System Data

Prior to programming LCR data using the portable computer PC-8300, system data relating to LCR must be programmed from a programming position keyset. Keys used for programming are shown in Figure 750-1.

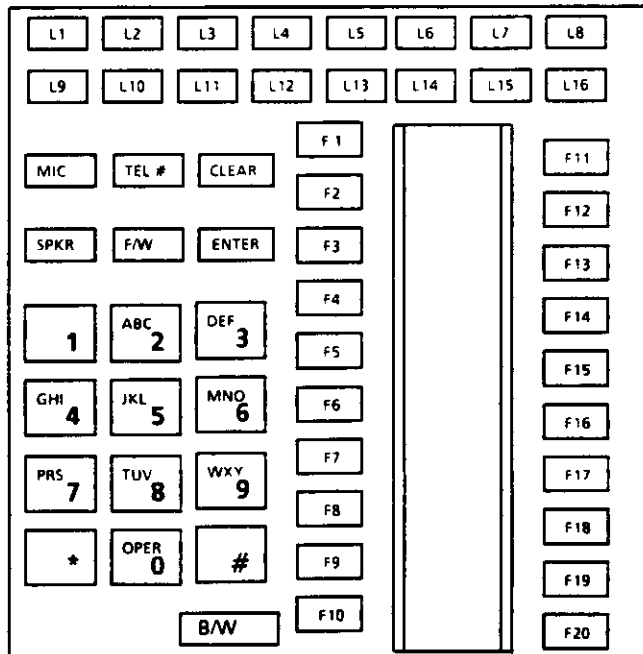

Figure 750-1 Programming Keys

### IMPORTANT

Before going into system data programming, make sure the switch SW1 on the LCR-E ETU is turned ON for battery backup of system data.

NOTE: Memory Blocks 2C1, 2C2 and 2C3 may have to be referenced for proper LCR operation.

Incoming Tie lines can use tandem access to seize outgoing trunks. Economy of service can be achieved by assigning LCR to the tandem ports associated with those Tie lines. This allows the system to route the tandem calls to the most economical line available.

#### a. Override of LCR

Override of LCR can be assigned by class of service on a station basis. When it is programmed to a station, LCR does not apply to the station.

#### b. LCR 1 Plus Dialing Assignment:

LCR 1 plus dialing assignment must be programmed if the location of the system is a 1 plus dialing area. This assignment is on a system basis.

#### c. Local Call Override

Local call override can be assigned on a system basis. When it is programmed, LCR does not apply to local calls on a system basis.

#### d. LCR Bypass

Should a station user find it necessary to bypass LCR, the user can directly access a CO line via a CO line button. A Single Line Telephone (SLT) or a Multiline Terminal without access to the CO network can be assigned LCR bypass (on a trunk access code group basis) via Memory Block 2B9. To assign LCR bypass, line button L2~L8 correspond to trunk access code group 2~8 respectively. Any line button LED that is lit when the ENTER key is depressed assigns the associated trunk access code group to bypass LCR.

#### 2. System/Station Speed Dial Consideration

System/Station speed dialing sometimes requires pause(s) between telephone numbers especially in cases using SCCs.

These pauses may cause the LCR-E ETU not to seize a least cost route, because these pauses may be considered digits dialed.

Pauses should be programmed as part of extra codes in the SCC table when system or static speed dialing is programmed to use SCCs.

The system data is programmed as follows:

MEMORY BLOCK 1D7 (Class of Service)

OPERATION

DISPLAY

- Go off line. (Depress **LK 16** and **SPKR** , then dial **#** , **\*** , **0** ).
- Depress **F1** , then **F9** .
- Depress **F17**
- Enter the station number to be programmed. (Example: Station 104). See NOTE 1.
- Depress **LK 13** , if required.  
(Override of LCR: Associated LED OFF  
Not override of LCR: Associated LED ON)  
See NOTE 2.
- Depress **ANS** . See NOTE 3.
- After all stations are programmed as required, depress **SPKR** to go on line.

	O	F	F	-	L	I	N	E		(	X	.	X	X	)
	P	R	O	G	R	A	M		M	O	D	E			

	T	E	R	M	I	N	A	L		F	E	A	T	U	R	E

	C	L	A	S	S		O	F		S	E	R	V	I	C	E
	T	E	L	?	?	?										

	C	L	A	S	S		O	F		S	E	R	V	I	C	E
	T	E	L	1	0	4										

	C	L	A	S	S		O	F		S	E	R	V	I	C	E
	T	E	L	1	0	5										

	1	0	:	4	5		O	C	T		2	8		F	R	I

- NOTE 1:** After the station number is entered, the LCD will show all previous assignments to the station.  
**NOTE 2:** If no change is required, proceed to step 7.  
**NOTE 3:** Depression of ANS causes the LCD to increment to the next station number.

MEMORY BLOCK 2B5 (LCR 1 Plus Dialing)

OPERATION

DISPLAY

- Go off line. (Depress **LK 16** and **SPKR** , then dial **#** , **\*** , **0** ).
- Depress **F2** , **F7** , then **F15** .
- Depress **LK 1** , if required.  
(1+ Dialing: Associated LED ON  
Not 1+ Dialing: Associated LED OFF)  
See NOTE 4.
- Depress **ANS** .
- Depress **SPKR** to go on line.

	O	F	F	-	L	I	N	E		(	X	.	X	X	)
	P	R	O	G	R	A	M		M	O	D	E			

	L	C	R		1	+	D	I	A	L						

	1	0	:	4	5		O	C	T		2	8		F	R	I

- NOTE 4:** If no programming change is required, go to Step 5.

MEMORY BLOCK 2B6 (Local Call Override)

OPERATION

1. Go off line. (Depress **LK 16** and **SPKR** , then dial **#** , **\*** , **0** ).
2. Depress **F2** , **F7** , then **F16** .
3. a. Depress L1 to assign whether or not local calls will override LCR:  
 L1 LED ON = Local calls route through LCR  
 L1 LED OFF = Local calls override (by-pass) LCR  
 b. Depress L2 to assign whether or not local calls dialed without a 1+ prefix, in a 1+ area, will bypass LCR:  
 L2 LED ON = Local calls in 1+ area bypass LCR.  
 L2 LED OFF = Local calls do not bypass LCR.
4. Depress **ANS** .
5. Depress **SPKR** to go on line.

DISPLAY

	O	F	F	-	L	I	N	E		(	X	.	X	X	)
	P	R	O	G	R	A	M		M	O	D	E			

L	C	R		L	O	C		C	A	L	L		O	V	E

L	C	R		L	O	C		C	A	L	L		O	V	E

1	0	:	4	5		O	C	T		2	8		F	R	I

MEMORY BLOCK 2B9 (LCR Bypass Assignment)

*2.5 REV*

OPERATION

← AND →

DISPLAY

1. Go off line.
2. Depress F2, then F7.
3. Depress F19.
4. Depress L2 thru L8 to select which trunk access code groups bypass LCR.  
 LED ON: Bypass LCR  
 LED OFF: Restricted
5. Depress ENTER key.
6. Depress SPKR key to go back on line.

	O	F	F	-	L	I	N	E		(	X	.	X	X	)
	P	R	O	G	R	A	M		M	O	D	E			

S	Y	S	.		F	E	A	T	U	R	E	2			

L	C	R		B	Y	P	A	S	S						
S	E	T		L	I	N	E		K	E	Y		2	-	8

L	C	R		B	Y	P	A	S	S						
S	E	T		L	I	N	E		K	E	Y		2	-	8

CAN'T HAVE BOT -

4. Prefix Add/Check (PFX ADD CHK)

When the prefix 1 is needed in front of the number to be dialed, regardless of the office code dialed, then YES should be programmed. When prefix 1 is not required, NO should be programmed. If whether or not the prefix 1 is to be added depends on the office code dialed, then CHK should be programmed. This will perform a check of this specified office code table and either add the prefix 1 or not depending on the information provided for the office code which was dialed.

→ NOTE: When the system resides in a 1+ Dialing area, prefix ADD/CHECK must be set to add as LCR ALWAYS STRIPS THE 1 WHEN IT IS DIALED BY THE USER.

5. Service Area Check (SVC AREA CHK)

→ If service on the selected route is available for all office codes, then NO should be programmed and NO Service Area Check will be performed. When CHK is programmed, the specified office code table will be checked for information on whether or not service to the office code dialed is provided by the selected route. If service is provided, the call will be completed. If service is

not provided, then the next route table in the Route Advance Table will be selected.

f. EXTRA CODE TABLES (ETR CODE TBL)

Sixteen (16) Extra Code Tables (00~15) are provided. Each Extra Code Table can contain a maximum of 24 digits. When EXTRA CODE ADD is programmed for CHK within a Route Table, the specified Extra Code Table will be referenced and the extra code it contains will be added in front of the number to be dialed.

g. OFFICAL CODE TABLES (OFC CODE TBL)

One Hundred Twenty- Eight (128) Office Code Tables (000~127) are provided. Each Office Code Table contains all the possible office codes and a flag bit for each office code which can be set either as 0 or 1. The meaning of the setting of each flag bit depends on whether the Office Code Table is referenced by the Prefix Add/Check or Service Area Check parameters of a given Route Table.

1. For Prefix Add/Check:

0 = The prefix 1 is to be added to the number to be dialed when this office code is dialed.

Route Advance Options

ITEM (Program Designation)	OPTIONS
TRUNK ACCESS CODE GROUP (TRK ACCS CODE)	1~8 The Trunk Group which corresponds to the Trunk Access Code Group related will be used to complete the call.
AREA CODE DELETE (AREA CODE DEL)	DEL - Delete the area code from the number to be dialed. → NO - includes the area code in the number to be dialed.
EXTRA CODE ADD (ETR CODE ADD)	ADD - adds the extra code from the specified Extra Code table in front of the number to be dialed. <i>Equal Access calls</i> NO - No extra code is added. <i>Account codes</i>
PREFIX ADD/CHECK (PFX ADD CHK)	YES - Add the Prefix 1 in front of the number to be dialed. <i>Area 1</i> NO - Do not add the Prefix 1. CHK - Whether or not the Prefix 1 is added depends on the office code dialed. This is determined by the information in the specified office code table.
SERVICE AREA CHECK (SRV AREA CHK)	NO - Service or the selected route is available for all office codes. CHK - checks the specified office code for information on whether the selected route provides service to the office code dialed.

1 = The Prefix 1 is not added when this office code is dialed.

2. For Service Area Check:

0 = Service is not provided by the specified route for this office code.

1 = Service is provided by the specified route for the office code.

system resides. This assignment is very important and **MUST** be made. When local calls (calls dialed without an area code) are to be routed through LCR the area code which is programmed into the Home NPA Table will be added to the number dialed.

**750.5 INITIALIZING THE PC-8300**

There are two types of initialization with the PC-8300 computer.

1. Cold Start - Used during initial installation or when battery failure occurs. All contents of RAM are erased.

h. HOME NPA TABLE (HOME NPA CODE)  
 One (1) Home NPA Table is provided. This table is used to enter the Area Code of the area in which the

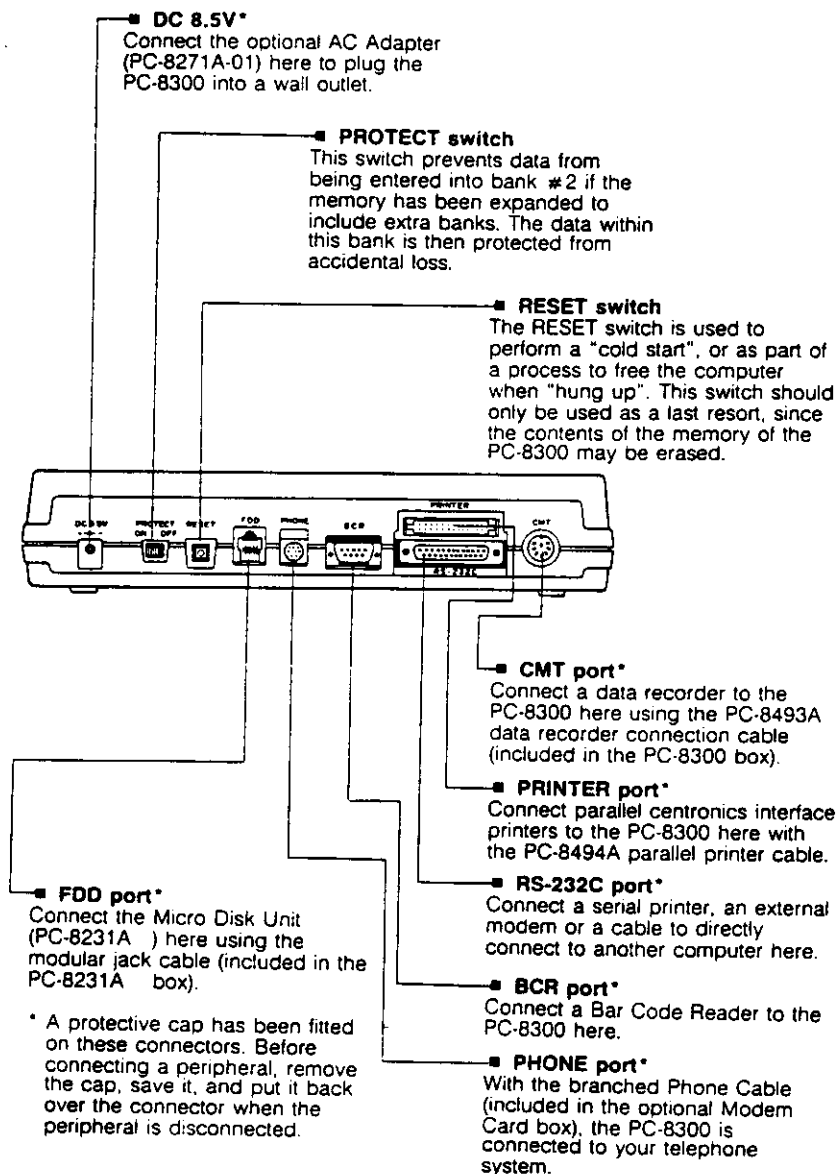

Figure 750-4 Rear Side View of the PC-8300

2. Warm Start - Used after installation and during normal operation to run the same program. All contents of RAM are retained.

Under normal operating conditions (after initial installation) the first display provided is the LCR Main Menu upon power up or reset.

#### 750.5.1 Cold Start Initialization

Under normal operating conditions the memory data in the PC-8300 is battery backed and is retained when the power switch is turned off. If the battery voltage drops too low, the memory may be lost and a cold start is required. The following procedure describes how to reinitialize the PC-8300. This procedure is also followed when the PC-8300 is first used for LCR programming.

1. Ensure that the batteries are fully charged and that the backup switch (located at the bottom of the PC-8300) is turned to the ON position.
2. Ensure that the LCR floppy disk is not installed in the disk drive unit (PC-8231A).

The micro floppy disk is removed by pushing the eject button until the disk is completely ejected.

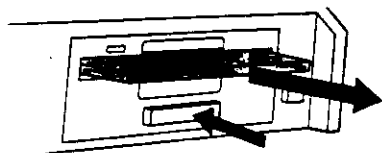

Figure 750-5 Removing the Floppy Disk

3. Ensure that both the PC-8300 and disk drive unit are turned off.
4. Close the write-protection hole on the floppy disk.

**NOTES:** 1. Opening the write-protection hole will prevent writing onto the micro floppy disk. Closing it will permit writing on to the micro floppy disk. Data and files which you do not wish erased are protected by opening the write-protection hole. To change or replace data or programs contained on the micro floppy disk, the write-protection hole must be closed. It opens and closes by way of a small slide switch.

2. Make sure the micro floppy disk is correctly inserted. When correctly inserted, a click will be

heard and the micro floppy disk will be pulled into the unit.

5. Insert the LCR floppy disk into the disk drive unit.

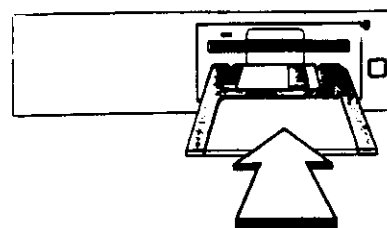

The micro floppy disk after insertion

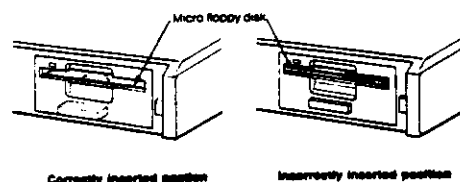

Figure 750-6 Inserting the Micro Floppy Disk

6. Turn the disk drive unit on. Ensure that the green LED goes on and that shortly thereafter the red LED turns on for a second or two and then turns off. If the red LED does not come on for a second or two and then turns off, go back to step 1 above.

**NOTE:** In step 7 below, the computer is turned on while depressing the SHIFT and CTRL keys. Cold start is also accomplished (with power to the computer already on) by depressing the RESET button (located on the rear of the PC-8300 while depressing the SHIFT and CTRL).

7. While depressing the SHIFT and CTRL key simultaneously, turn on the PC-8300. Ensure that the red LED on the disk drive lights for a second or two and then goes off. If this does not occur, go back to step 1 above.
8. Proceed to the auto start setting procedure.

#### 750.5.2 Warm Start

The Warm Start is performed by turning the power switch ON. This is the normal method used that allows retention of the LCR Main Menu program in the computer. Under normal conditions, the last screen displayed when power was turned off is returned when power is turned back on.

**750.5.3 Auto Start Setting**

The PC-8300 has an auto start feature which allows the computer to automatically load the LCR Main Menu program from the disk drive unit when the reset switch is used. The following procedure describes the setting of the auto start feature to automatically load the LCR Main Menu program.

1. With the PC-8300 main menu displayed, depress the **F1** key. Display shows:

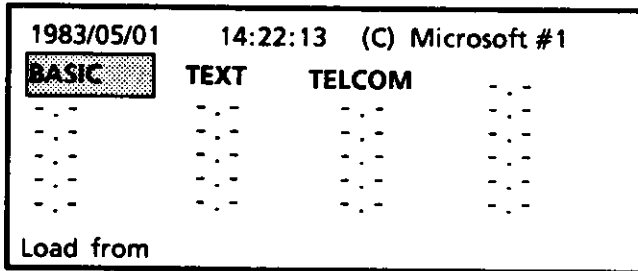

2. The computer is prompting for a file name to be loaded. The file name desired is IPL.DO. Since the file is in the disk, it is necessary to enter 1: prior to the file name. At this time use the keyboard (capital letters only) and enter the following: **1:IPL.DO** and depress the RETURN key to enter the data. Display shows:

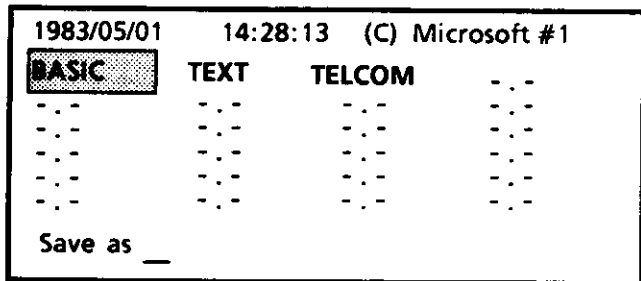
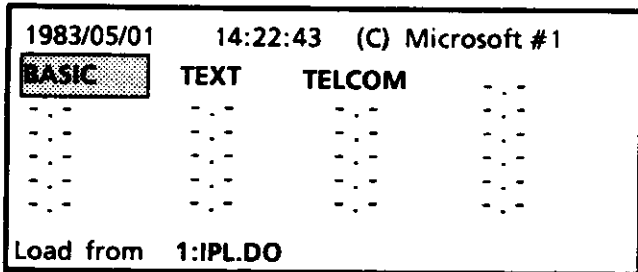

3. The computer now is prompting for the file name that the file will be stored in RAM. Enter **IPL.DO** and then depress the RETURN key to enter the data. Display shows:

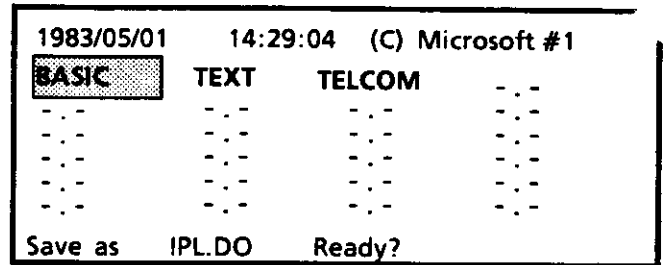

4. Depress the RETURN key or the letter Y (for yes). Display shows:

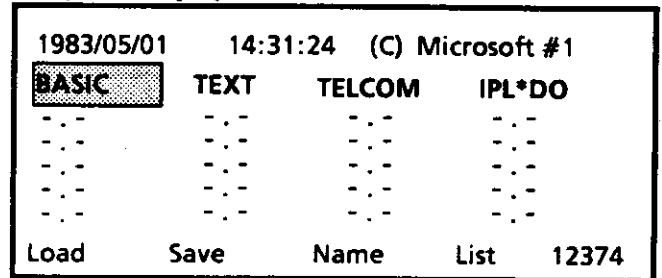

5. Using the cursor movement keys, move the cursor to the upper right corner of the display over the file name **IPL\*DO**. Depress the SHIFT key, while the SHIFT key is depressed, depress the **F1** key. Note that an asterisk is inserted in the file name at the upper right of the display (**IPL\*DO**) indicating that the file **IPL.DO** has been set as the new automatic loading file. Display shows:

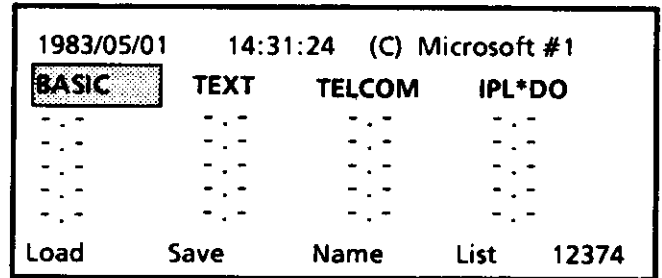

6. Now perform a Warm Start by depressing the RESET button located on the rear of the computer. The LCR Main Menu should appear in the display after a few seconds.

**750.6 PROGRAMMING THE LCR-E ETU**

**Key Layout and Explanation of Keys**

**GENERAL INFORMATION**

Once the initialization procedure has been completed, powering up the PC-8300 results in a display of the LCR main menu. (See section 740.5 for the initialization procedure if this has not been completed.)

Figure 750-7 shows the keyboard layout and the keys which are used during programming of the LCR-E ETU.



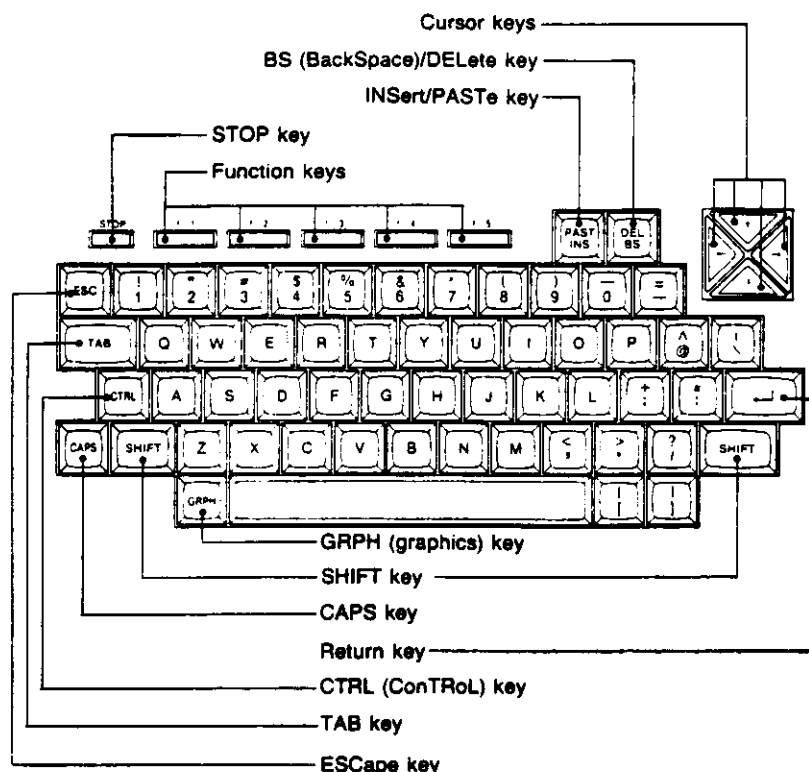

Figure 750-7 Keyboard Layout

**1. Number Keys (1-9 and 0)**

The number keys are used to enter data and to select menu options as required.

**2. CR (Carriage Return or Return)**

The return key is used as an enter key during programming. Normally this key will be depressed any time data is entered on the keyboard and after it is displayed on the screen. Shown below are some examples of the use of the CR key.

● To select a function from the main LCR menu, depress a number key and then depress CR (RETURN).

● While in the DOWN LOAD, UP LOAD, VERIFY, or SYSTEM DATA CLEAR functions, a RETURN arrow (shown at right) is provided. At this time, depressing CR (RETURN) is required to return to the preceding menu display.

**SAMPLE LCD INDICATIONS**

```

***LCR MAIN MENU***
1 DOWN LOAD      6 PRINT OUT
2 UP LOAD        7 SYSTEM DATA CLEAR
3 VERIFY         8
4 MODIFY         9
5 DISPLAY       10 SYSTEM CONTROL
ENTER MENU NO.
  
```

```

AREA CODE TABLE DOWN LOAD START
NORMAL END ←
  
```

- If a problem occurs during DOWN LOAD, UP LOAD, or VERIFY an error is displayed, as shown at right. Use of CR clears the display and returns it to the preceding menu.

- Whenever MODIFY, DISPLAY, or PRINT OUT is used, the carriage return is depressed after making the entries for selection of desired data.

- During MODIFY mode, CR (RETURN) is used to enter the selected data entries for a particular programming segment.

- During DISPLAY or PRINT OUT mode, CR (RETURN) is used to request display of additional data (in consecutive numerical order).

### 3. ESC - Escape Key

The ESC key is used to return to previous menu display any time a menu is displayed on the screen. Also, the ESC key is used in the MODIFY mode after completing the selection and/or entry of desired data.

- Example of ESC key being used to go from the DISPLAY menu to the LCR main menu.

- Depress ESC key. Display shows:

- During MODIFY mode, use of the ESC key causes data to be saved to the disk drive and then returns the display to the MODIFY menu, as shown at right.

### SAMPLE LCD INDICATIONS

```

AREA CODE TABLE DOWN LOAD START
ABNORMAL END
LINE TROUBLE ←
  
```

```

*** AREA CODE TABLE MODIFY***
TENANT NO. ? 1
  
```

```

***AREA CODE TABLE MODIFY***
TENANT NO. ? 1
AREA CODE ? 200
TABLE NAME : WEEKLY
TABLE NO. : 01
  
```

```

***AREA CODE TABLE DISPLAY***
TENANT NO. ? 1
AREA CODE ? 200
TABLE NAME : WEEKLY
TABLE NO. : 01
  
```

```

***DOWN LOAD***
AREA CODE TABLE 6 EXTRA CODE TABLE
2 WEEKLY SCHEDULE 7 OFFICE CODE TABLE
3 DAILY SCHEDULE 8 HOME NPA CODE
4 ROUTE ADVANCE 9
5 ROUTE TABLE 10 ALL DATA
ENTER MENU NO.
  
```

```

***LCR MAIN MENU***
1 DOWN LOAD 6 PRINT OUT
2 UP LOAD 7 SYSTEM DATA CLEAR
3 VERIFY 8
4 MODIFY 9
5 DISPLAY 10 SYSTEM CONTROL
ENTER MENU NO.
  
```

```

***AREA CODE TABLE MODIFY***
TENANT NO. ? 1
AREA CODE ? 200
TABLE NAME : WEEKLY
TABLE NO. : 01
  
```

**SAMPLE LCD INDICATIONS**

SYSTEM DATA SAVING

\*\*\*MODIFY\*\*\*  
 1 AREA CODE TABLE    6 EXTRA CODE TABLE  
 2 WEEKLY SCHEDULER   7 OFFICE CODE TABLE  
 3 DAILY SCHEDULER    8 HOME NPA CODE  
 4 ROUTE ADVANCE  
 5 ROUTE TABLE  
 ENTER MENU NO.

**4. Cursor Keys ( ↑, ↓, →, ← )**

The cursor keys ( the 4 arrow keys at the right of side of the keyboard) are used to move the cursor, on the screen, in the respective direction of the arrow shown on the key. This key is mainly used during the MODIFY mode.

**5. CTRL-X (Control key + X key)**

The CTRL key and the X key, when depressed at the same time, are used to delete an entry during the MODIFY mode.

• Shown at right is a display when in the MODIFY mode.

\*\*\*AREA CODE TABLE MODIFY\*\*\*  
 TENANT NO. ? 1  
 AREA CODE ? 200  
 TABLE NAME : WEEKLY  
 TABLE NO. : 01

• Depressing CTRL-X, clears the entry in the display. (When the ESC key is depressed this cleared entry is saved onto the disk in the disk drive.)

\*\*\*AREA CODE TABLE MODIFY\*\*\*  
 TENANT NO. ? 1  
 AREA CODE ? 200  
 TABLE NAME : \*\*\*\*\*  
 TABLE NO. : \*\*

**6. Space Bar**

The Space Bar is used to select desired options when in the MODIFY mode. The following examples indicate the various options selected by the Space Bar.

• In Area Code Table Modify mode, the Space Bar is used to select between WEEKLY and ROUTE ADVANCE Table assignment for the displayed Area Code. Depressing it once selects WEEKLY.

\*\*\*AREA CODE TABLE MODIFY\*\*\*  
 TENANT NO. ? 1  
 AREA CODE ? 200  
 TABLE NAME : WEEKLY  
 TABLE NO. : \*\*

• Depressing the Space Bar again will select ROUTE ADVANCE.

\*\*\*AREA CODE TABLE MODIFY\*\*\*  
 TENANT NO. ? 1  
 AREA CODE ? 200  
 TABLE NAME : ROUTE ADVANCE  
 TABLE NO. : \*\*

**SAMPLE LCD INDICATIONS**

**NOTES:** 1. If the entry is blank (\*\*\*\*\*), use of the Space Bar will display WEEKLY as the selected option.

2. Repeated use of the Space Bar will cause the selected option to alternate between WEEKLY and ROUTE ADVANCE.

3. Selection of WEEKLY tells the LCR-E processor to go look in the weekly schedule tables to determine the time of day and then the route advance table which is to be referenced.

4. Selection of ROUTE tells the LCR processor to immediately go to the route advance tables for further directions.

When in ROUTE TABLE MODIFY mode, the use of the Space Bar makes the selection of the various options available for each line in the ROUTE TABLE MODIFY display (except Table No. and Trunk Access Code, which are number entries).

● Example for Area Code Delete:

```

***ROUTE TABLE MODIFY***
TABLE NO. ? 100
TRK ACSS CODE      : **
AREA CODE DEL      : NO
ETR CODE ADD       : ***
PFX ADD CHK        : ***
SRV AREA CHK       : ***
  
```

● Depress Space Bar:

```

***ROUTE TABLE MODIFY***
TABLE NO. ? 100
TRK ACSS CODE      : **
AREA CODE DEL      : DEL
ETR CODE ADD       : ***
PFX ADD CHK        : ***
SRV AREA CHK       : ***
  
```

**NOTES:** 1. When the entry is blank (\*\*\*), use of the Space Bar provides NO as the selected option.

2. Repeated use of the Space Bar will cause the selected option to alternate between NO and DEL (DELETE).

➤ 3. Selection of NO tells the LCR-E that the area code should not be deleted when the number is dialed out by the system.

➤ 4. Selection of DEL tells the system to delete the area code when it dials out the number dialed by the user.

**SAMPLE LCD INDICATIONS**

- Example of Extra Code Add:

```

***ROUTE TABLE MODIFY***
TABLE NO.? 100
TRK ACSS CODE : **
AREA CODE DEL : ***
ETR CODE ADD : NO
PFX ADD CHK : ***
SRV AREA CHK : ***
  
```

- Depress Space Bar:

```

***ROUTE TABLE MODIFY***
TABLE NO.? 100
TRK ACSS CODE : **
AREA CODE DEL : ***
ETR CODE ADD : ADD ETR CODE TBL : **
PFX ADD CHK : ***
SRV AREA CHK : ***
  
```

**NOTES:** 1. When the entry is blank (\*\*\*), use of the Space Bar provides NO as the selected option.

2. Repeated use of the Space Bar will cause the selected option to alternate between NO and ADD.

3. Selection of NO tells the LCR-E that extra digits should not be added when the number is dialed out by the system.

4. Selection of ADD tells the system to add extra digits before it dials out the number dialed by the user. An entry of the associated Extra code table number is required when this option is selected.

*Equal Access codes  
 Account codes*

- Example of Prefix Add/Check:

```

***ROUTE TABLE MODIFY***
TABLE NO.? 100
TRK ACSS CODE : **
AREA CODE DEL : ***
ETR CODE ADD : ***
PFX ADD CHK : NO
SRV AREA CHK : ***
  
```

- Depress Space Bar:

```

***ROUTE TABLE MODIFY***
TABLE NO.? 100
TRK ACSS CODE : **
AREA CODE DEL : ***
ETR CODE ADD : ***
PFX ADD CHK : ADD
SRV AREA CHK : ***
  
```

- Depress Space Bar again:

```

***ROUTE TABLE MODIFY***
TABLE NO.? 100
TRK ACSS CODE : **
AREA CODE DEL : ***
ETR CODE ADD : ***
PFX ADD CHK : CHK OFC CODE TBL : ***
SRV AREA CHK : ***
  
```

SAMPLE LCD INDICATIONS

NOTES: 1. When the entry is blank (\*\*\*) use of the Space Bar provides NO as the selected option.

2. Repeated use of the Space Bar will cause the selected option to alternate between NO, ADD and CHK.

3. Selection of NO tells the LCR-E that the digit 1, as a prefix, should not be added when the number is dialed out by the system.

4. Selection of ADD tells the system to dial the digit 1 before it dials out the number dialed by the user. This option is used when an FX line that is selected requires 1 + dialing.

5. Selection of CHK(check) tells the LCR-E to look in an office code table for the central office code dialed by the user to determine whether to dial the digit 1 before dialing the number dialed by the user. It is required that an entry of an office code table number be made when this option is selected.

2010000

● Example of Service Area Check:

***ROUTE TABLE MODIFY***	
TABLE NO. ? 100	
TRK ACSS CODE	: **
AREA CODE DEL	: ***
ETR CODE ADD	: ***
PFX ADD CHK	: ***
SRV AREA CHK	: NO

● Depress Space Bar:

***ROUTE TABLE MODIFY***	
TABLE NO. ? 100	
TRK ACSS CODE	: **
AREA CODE DEL	: ***
ETR CODE ADD	: ***
PFX ADD CHK	: ***
SRV AREA CHK	: CHK OFC CODE TBL : ***

NOTES: 1. When the entry is blank (\*\*\*) use of the Space Bar provides NO as the selected option.

2. Repeated use of the Space Bar will cause the selected option to alternate between NO and CHK.

3. Selection of NO tells the LCR-E that no check of office code table is necessary. This option is used when the number dialed by the user is being routed to a line which will not use an OCC (Other Common Carrier). This option can also be selected if the OCC has no limitation relative to office code dialed by the user.

4. Selection of CHK (check) tells the LCR-E to look in an office code table for the central office code which the user dialed to determine whether this number can be dialed via an OCC. This option is used to determine whether the OCC to which the user is being routed provides service to the specified office code area.

Special use of the numbers 0 and 1 is made in the office code table assignment which may be required for either prefix check or service area check.

• The example at right shows how these are used.

• Depress 0 :

***OFFICE CODE TABLE MODIFY***											
TABLE NO. ? 0		0	1	2	3	4	5	6	7	8	9
OFC CODE ? 200	200	1	1	0	1	1	1	1	1	1	1
	210	1	1	1	1	1	1	1	1	1	1
	220	1	1	1	1	1	1	1	1	1	1
	230	1	1	1	1	1	1	1	1	1	1
	240	1	1	1	1	1	1	1	1	1	1

***OFFICE CODE TABLE MODIFY***											
TABLE NO. ? 0		0	1	2	3	4	5	6	7	8	9
OFC CODE ? 200	200	0	1	1	0	1	1	1	1	1	1
	210	1	1	1	1	1	1	1	1	1	1
	220	1	1	1	1	1	1	1	1	1	1
	230	1	1	1	1	1	1	1	1	1	1
	240	1	1	1	1	1	1	1	1	1	1

NOTES: 1. For service area check

0 = No service in area, check route advance table for next route available.

1 = Service is available, continue.

2. For prefix check

0 = Prefix required, add the digit 1 before the number to be dialed.

1 = No prefix required, do not add the digit 1 before the number to be dialed.

3. In the example above the cursor position is indicated by the box around the digit.

7. Other Keys Used ( P, #, \*, INS, DEL )

In MODIFY mode, other keys may be used within the Extra Code Table when assigning additional digits to be dialed out on the line to which the user is being routed. One possible application for this feature may be the need for dialing an access code plus a pause if the line is a PBX line. Another application might be the dialing of a local number followed by an account code if the line is to be used for dialing through an OCC. The use of a P in this table assignment means that the system is to pause when it gets to the P in the dialing sequence. The # and \* symbols will cause the system to dial the # or \*, respectively. The use of the INS key allows the programmer to insert digits in front of the present cursor position.

The use of DEL allows the programmer to delete the character located at the present cursor position. An example of both INS and DEL use follows.

- INS Key example:

```
***EXTRA CODE TABLE MODIFY***  
EXTRA CODE TABLE NO.? 1  
CODE [ * ] 10288
```

- Depress INS key:

```
***EXTRA CODE TABLE MODIFY***  
EXTRA CODE TABLE NO.? 1  
CODE [ * ] 10288  
  
INS MODE
```

- Depress 0 :

```
***EXTRA CODE TABLE MODIFY***  
EXTRA CODE TABLE NO.? 1  
CODE 0 [ * ] 10288  
  
INS MODE
```

**NOTES:** 1. During Insert mode, the display will show **INS MODE**, and the position to the left of the cursor is filled in with the new character.

2. The cursor is indicated by a box around the character at the present cursor position in the example above.

3. The use of the cursor keys removes the programmer from Insert Mode.

- Example of DEL (delete):

```
***EXTRA CODE TABLE MODIFY***  
EXTRA CODE TABLE NO.? 1  
CODE #OP [ * ] 10288
```

- Depress DEL :

```
***EXTRA CODE TABLE MODIFY***  
EXTRA CODE TABLE NO.? 1  
CODE #OP [ ] 0288
```

**NOTES:** 1. The use of delete causes the character under the cursor to disappear and all characters to the right shift left.

2. The cursor is indicated by a box over the character at the present cursor position in the example above.



## 750.7 INPUT OF DATA

### GENERAL

All input of data is done by starting at the LCR Main Menu. The LCR Main menu provides a selection of various functions which the programmer can access by selecting a number. Once a selection is made, the CR (RETURN) key is depressed and the program to access the selected function is loaded from the floppy disk into the computer. At this time a new menu is displayed which allows the programmer to select the table with which the programmer wishes to work. Again a number is selected from the menu and the CR key is depressed. The data for the chosen table is loaded from the floppy disk into the computer. At this stage in programming, various options may be available depending on which function was chosen from the LCR main menu. The data may now be modified, displayed, or printed out.

Based on the above information it can be seen that the meaning of any particular keystroke can be one of two meanings. The first is as a command. The second is as data.

From a menu, the selected number followed by a CR (RETURN) is to obtain the program for a specific function or to retrieve data for a specific table. Once table data is displayed the use of keys is to change data, move through the table to obtain specific data, or to enter new data.

To get out of a table the ESC (escape) key is depressed. At this time the data for that table is saved to the floppy disk (MODIFY MODE) and the previous menu is displayed. Depressing the ESC key again will return the programmer to the LCR main menu or selecting a new number and depressing a CR (RETURN) allows retrieval of another table.

As an aid in understanding the programming procedure, refer to Figure 750-8, the general programming flow diagram. This diagram provides a general overview of programming procedure. As is

shown in the diagram, 8 functions are available while at the LCR main menu. At any time, only one function (or operational mode) can be used. The use of a second function is only available by escaping back to the LCR Main Menu.

Once a function is selected, a new menu is provided (except SYSTEM CONTROL) where a table type can be selected. From the Main Menu, selecting SYSTEM CONTROL sends a reset signal to the LCR-E; then allows return to the Main Menu.

A study of the general programming diagram shows that, in all other functions, after selecting a table type, different operations are available based on the chosen function.

In the following sections of this document is provided a detailed explanation of each of the functions shown in the general diagram.

For an explanation of the LCR Main Menu, refer to section 750.8.1. That section also gives a brief description of the 8 available functions.

Section 750.8.2 provides an in-depth explanation of each function as related to the programming procedure.

In general, the DOWN LOAD, UP LOAD and Verify functions are used for the maintenance function whereby data is transferred to and from the LCR-E and the LCR disk.

The MODIFY MODE is used to customize the data, for a specific application, on the LCR Disk. The DISPLAY MODE is used to examine data without changing data. (This is similar to the MODIFY MODE but runs faster because no changing or saving of data is done.) PRINTOUT is used to retrieve a printed copy of the system data. SYSTEM DATA CLEAR is used to clear the data on the disk which is no longer desired.

# GENERAL PROGRAMMING FLOW DIAGRAM

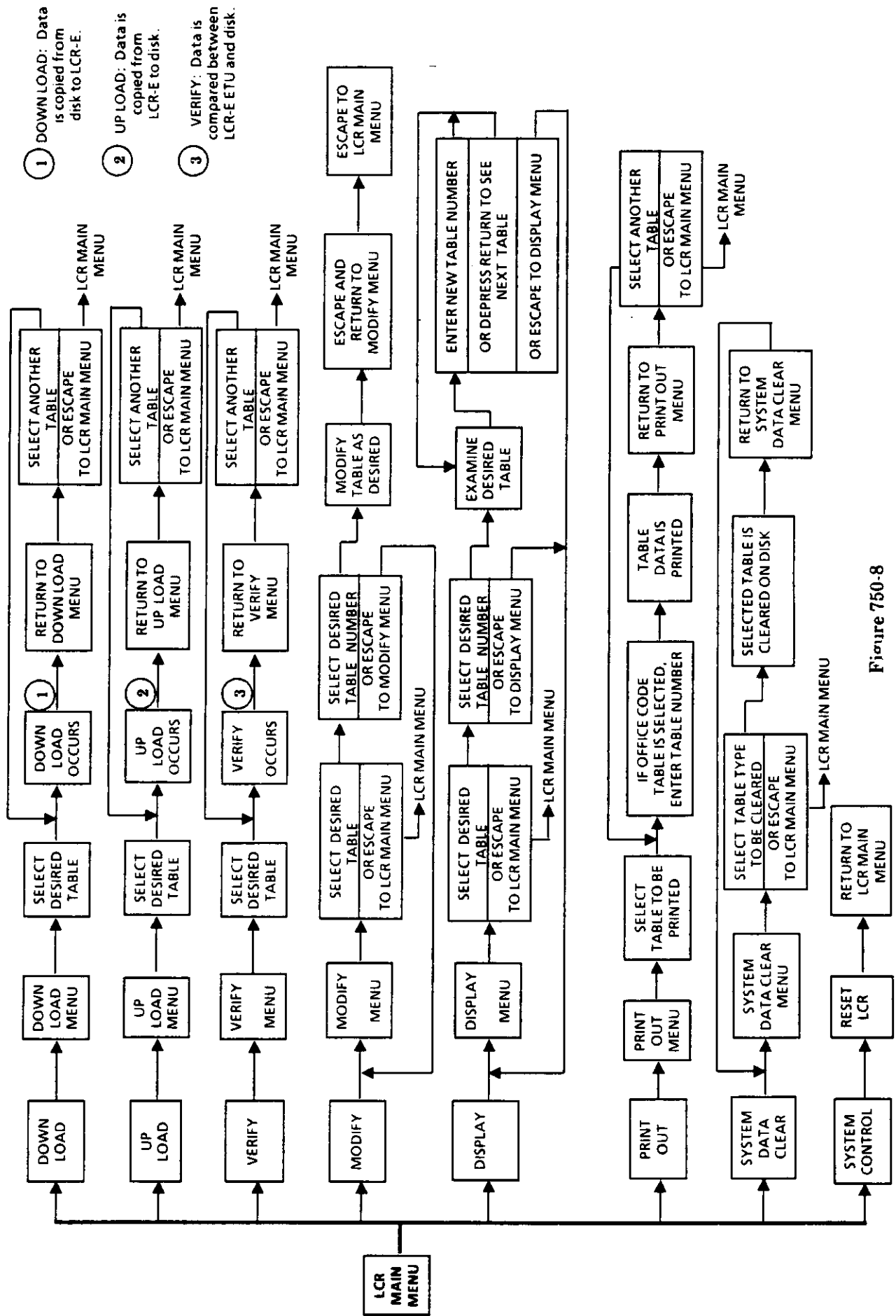

Figure 750-8

Examples are provided below.

**1. Selecting a function from the LCR Main Menu.**

- With the LCR Main Menu displayed

```
***LCR MAIN MENU***
1 DOWN LOAD          6 PRINT OUT
2 UP LOAD            7 SYSTEM DATA CLEAR
3 VERIFY              8
4 MODIFY              9
5 DISPLAY            10 SYSTEM CONTROL
ENTER MENU NO.  1
```

- Depress 4 then CR (RETURN) key.

```
PROGRAM LOADING
```

- The program for Modify is loaded from the floppy disk and the display shown is provided.

```
***DOWN LOAD***
1 AREA CODE TABLE  6 EXTRA CODE TABLE
2 WEEKLY SCHEDULE  7 OFFICE CODE TABLE
3 DAILY SCHEDULE   8 HOME NPA CODE
4 ROUTE ADVANCE
5 ROUTE TABLE     10 ALL DATA
ENTER MENU NO. 
```

At this time any table to be down loaded can be chosen.

**NOTE:** Only one table can be loaded into the computer at a time. This applies to all functions.

**2. Selecting a table from a function menu.**

- With the Modify Menu displayed:

```
***MODIFY***
1 AREA CODE TABLE  6 EXTRA CODE TABLE
2 WEEKLY SCHEDULER 7 OFFICE CODE TABLE
3 DAILY SCHEDULER  8 HOME NPA CODE
4 ROUTE ADVANCE
5 ROUTE TABLE
ENTER MENU NO. 
```

- Depress 1, then the CR (RETURN) key.

```
SYSTEM DATA LOADING
```

(The program for modifying the table chosen is loaded.)

- Once the program is loaded the table is displayed.

**3. Example of Table Input.**

Once table data is retrieved, the number of the specific table to be displayed (or in this case modified) must be entered, followed by pushing the CR (RETURN) key.

- With Area Code table modify displayed:

- Depress 01, then CR (RETURN) key.

- Depress 200, then CR (RETURN) key.

- Depress Space Bar, then CR (RETURN) key (Tone is provided.)

- Depress 01 (Table for the 200 area code is filled)

**4. Example of Moving through a Table.**

Moving through a table is done by depressing a CR (RETURN). When in a table, depressing the CR (RETURN) enters the data into the computer and increments the specific item number being viewed. If no data is displayed for a specific item within a table the data remains blank. A blank entry is shown by \*\*\* in the display. In some

SAMPLE LCD INDICATIONS

PROGRAM LOADING

\*\*\*AREA CODE TABLE MODIFY\*\*\*  
 TENANT NO. ?

\*\*\*AREA CODE TABLE MODIFY\*\*\*  
 TENANT NO. ?

\*\*\*AREA CODE TABLE MODIFY\*\*\*  
 TENANT NO. ? 1  
 AREA CODE ?

\*\*\*AREA CODE TABLE MODIFY\*\*\*  
 TENANT NO. ? 1  
 AREA CODE ? 200  
 TABLE NAME : \*\*\*\*\*  
 TABLE NO. : \*\*

\*\*\*AREA CODE TABLE MODIFY\*\*\*  
 TENANT NO. ? 1  
 AREA CODE ? 200  
 TABLE NAME : WEEKLY  
 TABLE NO. : \*

\*\*\*AREA CODE TABLE MODIFY\*\*\*  
 TENANT NO. ? 1  
 AREA CODE ? 200  
 TABLE NAME : WEEKLY  
 TABLE NO. : 01

tables more than one item (for example - area codes) may be available for display or modification. In this case depression of the appropriate item number in the line which shows item number (followed by CR (RETURN)) will display the contents for that item.

Shown is the use of CR (RETURN) to increment the item number.

- With Area Code Table Modify in the display as shown at right:

- Depress CR (RETURN) key.

- Depress CR (RETURN) again to display the contents (See Notes below).

- To return to the previous menu, depress the ESC key.

**NOTES:** 1. After the first carriage return above, the cursor is positioned at the new item number line. At this time a different item number may be chosen. If this is done before the carriage return the data contents of the chosen item number will be displayed. This option applies to modify mode only.

2. The first CR (RETURN) above increments the item number. The second CR (RETURN) displays the data for the item number.

### 750.8 Explanation of LCR Commands

This section explains the LCR (RETURN) support terminal commands required to properly program the required data for proper operation of the LCR-E ETU. It is recommended that section 750.7 be fully read and understood prior to reading this section.

Once the initialization procedure has been completed, powering up the PC-8201A/PC-8300 results in display of the LCR main menu. (See section 750.5 for the initialization procedure if this has not been completed.) The LCR main menu provides the programmer with 8 options.

### SAMPLE LCD INDICATIONS

```
***AREA CODE TABLE MODIFY***
TENANT NO. ? 1
AREA CODE ? 200
TABLE NAME : WEEKLY
TABLE NO. : 01
```

```
***AREA CODE TABLE MODIFY***
TENANT NO. ? 1
AREA CODE ? 201
```

```
***AREA CODE TABLE MODIFY***
TENANT NO. ? 1
AREA CODE ? 201
TABLE NAME : ******
TABLE NO. : **
```

The options and key in numbers are:

- |               |                       |
|---------------|-----------------------|
| 1 - Down Load | 5 - Display           |
| 2 - Up Load   | 6 - Print Out         |
| 3 - Verify    | 7 - System Data Clear |
| 4 - Modify    | 10 - System Control   |

NOTE: Key in numbers 8 and 9 are not used.

The selection of any option above (except System Control) results in the display of a second menu.

- With the Main Menu displayed, depress the number of the desired function and press CR (RETURN) key.

### SAMPLE LCD INDICATIONS

```
***LCR MAIN MENU***  
1 DOWN LOAD          6 PRINT OUT  
2 UP LOAD            7 SYSTEM DATA CLEAR  
3 VERIFY             8  
4 MODIFY             9  
5 DISPLAY           10 SYSTEM CONTROL  
ENTER MENU NO. 04
```

#### 750.8.1 General Explanation of LCR Main Menu Options

##### 1. Down Load

The Down Load option is used to transfer data from the floppy disk to the LCR-E ETU. It should not be confused with normal loading which is from the floppy disk to the computer. This option is generally used after data has been changed on the floppy disk. No change to the actual working memory on the LCR-E occurs until this procedure is completed.

##### 2. Up Load

The Up Load option is used to transfer data from the LCR-E ETU to the floppy disk. This option is generally used to retrieve the actual programmed data presently in the LCR-E ETU. This might be done to check the actual contents of the LCR-E.

##### 3. Verify

The Verify option is used to compare the contents of the LCR-E ETU to the contents of the floppy disk. This option is used after a down load or up load to verify that the transfer of data just completed was completed properly and no problem was encountered that was not caught by the computer. Also this option can be used to check that a floppy disk contains the latest program presently in the LCR-E ETU.

##### 4. Modify

The Modify option is used to change the data in the floppy disk. This option is the main function used by the programmer in customizing the LCR program. It should be noted that this option changes only the data in the floppy disk, not in the LCR-E ETU.

### 5. Display

The Display option is used to allow the programmer to view the contents of the data presently in the floppy disk. This option does not allow changing of data, and is used only to confirm the present data.

### 6. Print Out

The Print Out option is used to send table data to a printer for purposes of having a hard copy. This option is recommended to be completed as the last step after verification of proper LCR function, to obtain a hard copy of the LCR program.

The office code table can be printed as follows: with the **PRINT OUT** menu in the display, depress  and

Enter the start table number and depress . Example 001.

Enter the end table number and depress . Example 002.

### 7. System Data Clear

The system data clear option is used to clear data from the tables. This option clears the data in the floppy disk, not the LCR-E ETU. The option is provided to clear only one table at a time.

### 8. System Control

The system control option is used to restart the LCR-E ETU. This option is recommended for use after any changes are made to the programming in the LCR-E.

#### 750.8.2 Command Descriptions

In general, commands from the main menu result in the display of a second menu (except for system control). This menu is a listing of the available tables. Programming is done on a per table basis.

### SAMPLE LCD INDICATIONS

***OFFICE CODE TABLE PRINT***	
TABLE NO. FROM	<input type="text" value=""/>

***OFFICE CODE TABLE PRINT***	
TABLE NO. FROM	<input type="text" value="001"/>
TO	<input type="text" value=""/>

***OFFICE CODE TABLE PRINT***	
TABLE NO. FROM	<input type="text" value="001"/>
TO	<input type="text" value="002"/>

SYSTEM DATA LOADING <input type="checkbox"/>
--

OFFICE CODE TABLE PRINTOUT START <input type="checkbox"/>
---

**1. Down Load Mode**

- Selection of down load mode results in the menu display at right.

At this time selection of one of the available table numbers will result in the following display.

- Example for area code down load: Depress 1, then CR (RETURN).

**NOTES:** 1. The display shown is an example of area code data being down loaded from the floppy disk into the LCR-E. The name of the table chosen will be shown in the display.

2. Exceptions to note 1, are the office code table and all data down load selections. These two selections, due to their large memory requirements show darkened boxes to indicate the relative amount of data that has been transferred.

3. If no problem is encountered during down load the display shown (or one similar to it) is provided. Depression of the CR (RETURN) key is required to return to the down load menu.

4. If a problem is encountered during down load the display shown (or one similar to it) is provided. Depression of the CR (RETURN) key is required to return to the down load menu.

5. It is recommended that the RS-232C cable between the LCR-E ETU and the computer be checked prior to doing a down load or up load.

**2. Up Load Mode**

- Selection of up load mode results in the menu display shown:

**SAMPLE LCD INDICATIONS**

\*\*\*DOWN LOAD\*\*\*  
 1 AREA CODE TABLE    6 EXTRA CODE TABLE  
 2 WEEKLY SCHEDULE    7 OFFICE CODE TABLE  
 3 DAILY SCHEDULE     8 HOME NPA CODE  
 4 ROUTE ADVANCE  
 5 ROUTE TABLE        10 ALL DATA  
 ENTER MENU NO.

AREA CODE TABLE DOWN LOAD START

OFFICE CODE TABLE DOWN LOAD START  
 ■ ■ ■ ■ ■ ■ ■ ■

ALL DATA UP LOAD START  
 ■ ■ ■ ■ ■ ■ ■ ■ ■ ■

AREA CODE TABLE DOWN LOAD START  
 NORMAL END ←

AREA CODE TABLE DOWN LOAD START  
 ABNORMAL END  
 LINE TROUBLE

\*\*\*UP LOAD\*\*\*  
 1 AREA CODE TABLE    6 EXTRA CODE TABLE  
 2 WEEKLY SCHEDULE    7 OFFICE CODE TABLE  
 3 DAILY SCHEDULE     8 HOME NPA CODE  
 4 ROUTE ADVANCE  
 5 ROUTE TABLE        10 ALL DATA  
 ENTER MENU NO.



At this time selection of one of the available table numbers will result in the display shown:

- Example for area code up load: Depress 1, then CR (RETURN).

**NOTES:** 1. The display shown is an example of area code data being up loaded from the LCR-E into the floppy disk. The name of the table chosen will be shown in the display.

2. Exceptions to note 1, are the office code table and all data up load selections. These are shown in the All Data Up Load Start display. These two selections, due to their large memory requirements show darkened boxes to indicate the relative amount of data that has been transferred.

3. If no problem is encountered during up load the display shown at right (or one similar to it) is provided.

Depression of the CR (RETURN) key is required to return to the down load menu.

4. If a problem is encountered during up load the following display (or one similar to it) is provided. Depression of the CR (RETURN) key is required to return to the up load menu.

5. It is recommended that the RS-232C cable between the LCR-E ETU and the computer be checked prior to doing a down load or up load.

### 3. Verify Mode

Selection of verify mode results in the menu display shown at right.

At this time selection of one of the available table numbers will result in the display shown at right:

Example for area code verify: Depress 1, then CR (RETURN).

## SAMPLE LCD INDICATIONS

AREA CODE TABLE UP LOAD START

OFFICE CODE TABLE UP LOAD START  
 ■ ■ ■ ■ ■ ■ ■ ■

ALL DATA UP LOAD START  
 ■ ■ ■ ■ ■ ■ ■ ■ ■ ■ ■ ■

AREA CODE TABLE UP LOAD START  
 NORMAL END ←

ALL DATA UP LOAD START  
 ABNORMAL END(OFFICE CODE TABLE)  
 LINE TROUBLE ←

\*\*\*VERIFY\*\*\*  
 1 AREA CODE TABLE    6 EXTRA CODE TABLE  
 2 WEEKLY SCHEDULE    7 OFFICE CODE TABLE  
 3 DAILY SCHEDULE    8 HOME NPA CODE  
 4 ROUTE ADVANCE  
 5 ROUTE TABLE    10 ALL DATA  
 ENTER MENU NO.

AREA CODE TABLE VERIFY START

NOTES: 1. The previous display is an example of area code data being verified between the floppy disk and the LCR-E. The name of the table chosen will be shown in the display.

2. Exceptions to note 1, are the office code table and all data verify selections. These are shown at right. These two selections, due to their large memory requirements show darkened boxes to indicate the relative amount of data that has been transferred or verified.

3. If no problem is encountered during verify the display shown (or one similar to it) is provided. Depression of the CR (RETURN) key is required to return to the verify menu.

4. If a problem is encountered during verify, the display shown (or one similar to it) is provided. Depression of the CR (RETURN) key is required to return to the verify menu.

5. It is recommended that the RS-232C cable between the LCR-E ETU and the computer be checked prior to performing a verify.

#### 4. Modify Mode

The modify mode is used to make changes to the LCR data base in the floppy disk. In this mode the programmer customizes the LCR program to accommodate the need of the system user. With the LCR main menu displayed depress 4 and then CR (RETURN). The Modify program is now loaded from the floppy disk and the display shown is provided.

At this time the programmer is given the option to select which table is to be modified. At any given time only one table type can be modified. The following pages provide an example of each table as it is being modified, and the associated displays provided by the computer. Prior to actually making any program changes it is recommended that the programmer have a complete listing of all desired data clearly written down for easy reference while programming LCR.

### SAMPLE LCD INDICATIONS

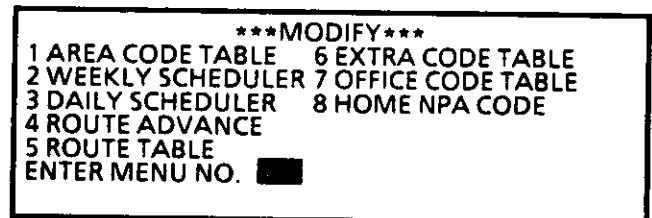
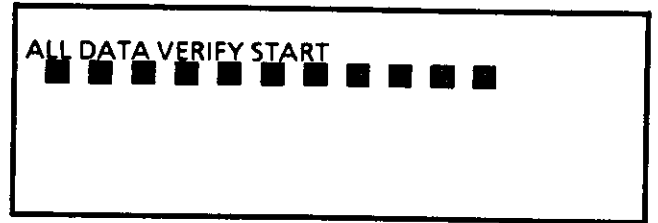

SAMPLE LCD INDICATIONS

**a. Area Code Table Modify**

With the Modify Menu displayed, depress 1, then CR (RETURN).

The computer loads the area code table data from the floppy disk and, when done, displays the Area Code Table Modify display as shown.

```
***AREA CODE TABLE MODIFY***  
TENANT NO.  ? 
```

At this time, enter the tenant number for which the area code assignments are to be made. Depress a number 1-3, then CR (RETURN).

```
***AREA CODE TABLE MODIFY***  
TENANT NO.  ? 1  
AREA CODE   ? 
```

**NOTE:** Although it is possible to enter 0 as a tenant number this assignment has no function when used with the Electra MarkII and will result in no operation, or incorrect operation, of the LCR.

Now type in the area code to be assigned, then CR (RETURN). The example shows the display for selection of tenant 1 and area code 200.

```
***AREA CODE TABLE MODIFY***  
TENANT NO.  ? 1  
AREA CODE   ? 200  
TABLE NAME  : *****  
TABLE NO.   : **
```

Based on the area code dialed the LCR determines which tables should be examined. The first decision that must be made is the type of tables to be routed through. Two types of tables can be selected based on the area code. The first type is the weekly schedule tables. The second type is the route advance tables. Depress the Space Bar to select the type of table. The first depression of the Space Bar causes the display to show WEEKLY as the selected table type.

```
***AREA CODE TABLE MODIFY***  
TENANT NO.  ? 1  
AREA CODE   ? 200  
TABLE NAME  : WEEKLY  
TABLE NO.   : **
```

Depressing the Space Bar again selects ROUTE ADVANCE as the selected table type. After selecting the table type depress the Cursor Down key to get to the Table No. line and enter the desired table number (for the table type chosen). The example shows the selection of WEEKLY table number 10. A maximum of 64 tables can be selected (00-63) for either WEEKLY or ROUTE ADVANCE.

```
***AREA CODE TABLE MODIFY***  
TENANT NO.  ? 1  
AREA CODE   ? 200  
TABLE NAME  : WEEKLY  
TABLE NO.   : 10
```

Once the above steps are completed, two options are available. If corrections are required the use of the Cursor Up key allows returning to the line requiring change. If no changes to the data is required depress the CR (RETURN) and the display increments to the next table number. Selection of a new area code can be made at this time or depressing CR (RETURN).

displays the data for the area code number in the display.

Once all changes to area code assignment are made the programmer depresses the ESC key and the data is saved to the floppy disk as shown.

**NOTES:** 1. The area code assignments made in these tables determine which tables will be searched by the LCR-E. In the above examples it should be noted that the selection of WEEKLY sends the LCR to the WEEKLY schedule tables. If ROUTE ADVANCE is chosen the LCR-E will proceed to look in the ROUTE ADVANCE tables for further directions. The use of WEEKLY tables eventually results in the selection of route advance tables (via the DAILY tables). In both cases, the least cost route is selected from the final information located in the Route Tables.

2. Data is not saved onto the floppy disk until the ESC (escape) key is depressed. At that time the display is returned to the Modify Menu.

**b. Weekly Schedule Table Modify**

The option of selecting a different route based on day of week and time of day is made available by assigning the table type as weekly in the area code tables. If this option is chosen it is necessary to assign weekly tables and then daily tables. The following steps show the procedure for weekly schedule table assignments.

With the Modify Menu in the display, depress 2, then CR (RETURN). The display at right is provided.

**c. Daily Schedule Table Modify**

The daily schedule tables are used to select different assignments of route advance tables for a specific area code based on the time of day. The available assignments are done on an hourly basis using military time (0-23 hours).

To assign the daily schedule tables the following steps are used:

With the Modify Menu in the display, depress 3 then CR (RETURN). The display shown will be provided.

Available entries are now 00-63. This is the number of the daily schedule table to be modified. Depress the number desired, then depress CR (RETURN). The example below is for table 03.

**SAMPLE LCD INDICATIONS**

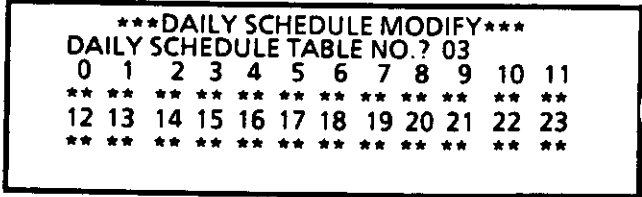
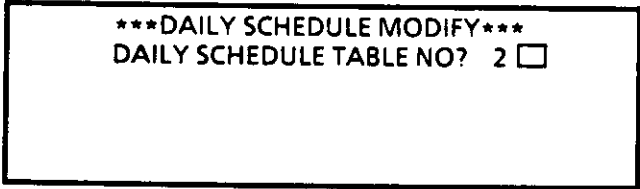

**SAMPLE LCD INDICATIONS**

Once the table data is displayed the programmer must enter the route advance table number to which the LCR-E should refer, to determine which route table will be used to process the attempted call.

```
***DAILY SCHEDULE MODIFY***  
DAILY SCHEDULE TABLE NO.? 03  
0 1 2 3 4 5 6 7 8 9 10 11  
01 01 01 01 01 01 01 01 01 00 00 00  
12 13 14 15 16 17 18 19 20 21 22 23  
00 00 00 00 00 00 01 01 01 00 00 00
```

Route advance tables are numbered 00-63. One of these table numbers should be assigned under each hourly number showing in the display. In the daily schedule display, the numbers 0-23 correspond to the hours of the day, in military time. If hour 0 is assigned a table, that table will be referred to from the hour of midnight to 00:59:59 AM. The use of hour number 13 refers to the time between 01:00:00 PM and 01:59:59 PM.

```
***DAILY SCHEDULE MODIFY***  
DAILY SCHEDULE TABLE NO.? 04
```

After selecting a table assignment for each hour, depressing the CR (RETURN) enters the data into the computer for that table and increments the table number by 1. Depressing the return key will now allow programming of the next table. Prior to depressing the return key a second time, the programmer can enter a new table number to be modified.

**NOTES:** 1. The use of cursor keys allows the programmer to freely move the cursor position to correct any mistakes made during entry of data.

2. If any hourly assignments are left blank (unassigned) when the LCR-E looks at this table during that hour, busy tone is returned to the calling party and therefore the calling party is restricted.

3. No data is entered into the floppy disk until the ESC key is depressed. At the time that the ESC key is depressed, the data is saved to the floppy disk and the display is returned to the Modify Menu.

**d. Route Advance Table**

The route advance table is used to select which route tables will be used by the LCR-E to determine the trunk to be used to process the attempted call. The route advance table makes available to the programmer up to four different route table assignments which can be used by the LCR-E to find the trunk to be used. The priority of selection is from top to bottom, first to fourth route table number assignment. The following steps show how to modify the route advance tables.

With the Modify Menu in the display, depress 4, then CR (RETURN). The display at right will be provided.

Now enter the number of the route advance table to be modified, then CR (RETURN). The example shows table 20.

Now entered is the route table to be used by the LCR-E as the first, second, third, or fourth route. Available assignments for route tables are 000-255. The reason for providing up to four routes is in case the first route is busy, or cannot be used for a given reason the LCR-E can continue to choose a different route of slightly higher cost but does not restrict the user, until an available route is found. If all routes are unavailable the user is restricted.

Once all desired routes are assigned a route advance table, depressing the CR (RETURN) enters the data into the computer and increments the route advance table number by one. Depressing the return key will now allow programming of the next table. Prior to depressing the return key a second time, the programmer can enter a new table number to be modified.

**NOTES:** 1. The use of the cursor keys allows the programmer to make corrections to the data if any mistakes are made during data entry.

2. No data is entered into the floppy disk until the ESC key is depressed. At the time that the ESC key is depressed, the data is saved to the floppy disk and the display is returned to the Modify Menu.

**e. Route Table Modify**

The route table is the heart of the LCR programming. The purpose of the other tables previously discussed is to allow the LCR-E to reach a specific route table based on the area code dialed and either the time of day and day of week (if used) and/or based on the available routes.

Each route table contains specific data which is used by the LCR-E to determine not only which trunk access code will be used to select the trunk but also the manner in which the number is to be dialed. The following steps are used to properly assign route tables.

**SAMPLE LCD INDICATIONS**

```
***ROUTE ADVANCE MODIFY***  
ROUTE ADVANCE TABLE NO. ? 
```

```
***ROUTE ADVANCE MODIFY***  
ROUTE ADVANCE TABLE NO. ? 20  
1ST ROUTE TABLE NO. : ***  
2ND ROUTE TABLE NO. : ***  
3RD ROUTE TABLE NO. : ***  
4TH ROUTE TABLE NO. : ***
```

```
***ROUTE ADVANCE MODIFY***  
ROUTE ADVANCE TABLE NO. ? 20  
1ST ROUTE TABLE NO. : 010  
2ND ROUTE TABLE NO. : 011  
3RD ROUTE TABLE NO. : 001  
4TH ROUTE TABLE NO. : 004
```

```
***ROUTE ADVANCE MODIFY***  
ROUTE ADVANCE TABLE NO. ? 21
```

**SAMPLE LCD INDICATIONS**

With the Modify Menu in the display, depress 5, then CR (RETURN). The display at right will be provided.

```

***ROUTE TABLE MODIFY***
TABLE NO. ?   [ ] [ ]
  
```

The number of the route table to be modified is now entered, followed by a CR (RETURN). Available route tables are 000-255. The example at right shows table 120.

```

***ROUTE ADVANCE MODIFY***
TABLE NO. ?  120
TRK ACSS CODE :  [ ] *
AREA CODE DEL :  ***
ETR CODE ADD  :  ***
PFX ADD CHK   :  ***
SRV AREA CHK  :  ***
  
```

Data is now entered from top to bottom, starting at TRK ACSS CODE (trunk access code). The entry for trunk access code determines which trunk access code will be used by the system CPU to select a trunk.

```

***ROUTE ADVANCE MODIFY***
TABLE NO. ?  120
TRK ACSS CODE :   01
AREA CODE DEL :  [ ] ***
ETR CODE ADD  :  ***
PFX ADD CHK   :  ***
SRV AREA CHK  :  ***
  
```

Depress the number of the trunk access code desired and the cursor will jump down to the AREA CODE DEL line automatically. If an incorrect number is entered the Cursor UP key can be used to return to the TRK ACSS CODE line for correction. Although the computer will accept entries from 00-15 as trunk access code, only codes 01-08 will work on the Electra MarkII.

The next data to be entered is on the AREA CODE DEL line. This entry determines whether the area code dialed by the caller should be dialed out on the chosen trunk. This option is provided in case the caller is being routed to a line (such as an FX line) where it is not necessary to dial the area code. Depressing the space bar allows selection of one of two options for this line. The first time the space bar is depressed selects NO (do not delete) as the entry. The second depression of the space bar selects DEL (delete) as the entry. The example shows the selection of DEL as the entry.

```

***ROUTE TABLE MODIFY***
TABLE NO. ?  120
TRK ACSS CODE :   01
AREA CODE DEL :  DEL
ETR CODE ADD  :  ***
PFX ADD CHK   :  ***
SRV AREA CHK  :  ***
  
```

After area code delete selection is made, depress the cursor down key to position the cursor at the ETR CODE ADD line. This option is used to tell the LCR-E whether it is necessary to dial extra digits prior to dialing out the number dialed by the caller. Depressing the space bar will cause the display to show a NO as the entry for this line.

```

***ROUTE TABLE MODIFY***
TABLE NO. ?  120
TRK ACSS CODE :   01
AREA CODE DEL :  DEL
ETR CODE ADD  :  NO
PFX ADD CHK   :  ***
SRV AREA CHK  :  ***
  
```

If it is desired to add digits before the number dialed, depress the space bar again. This option may be desired for an SCC (secondary common carrier) call where it may be necessary to dial a local number followed by an account code prior to dialing the long distance number. Another application might be where the call is being routed through a PBX (or Centrex) line where it may be necessary to dial an access code prior to obtaining CO (central office) dial tone. The display at right is now observed.

It is necessary to enter a table number for the Extra code table to be referred to by the LCR-E if extra digits are to be dialed. Available entries are 00-15.

Depress the number keys for the desired table assignment.

After entering the table number for extra code the display automatically drops to the next line - PFX ADD CHK. If NO was entered in the extra code add line it is necessary to use the cursor down key to get to the PFX ADD CHK line.

Once at the PFX ADD CHK line depress the space bar to select NO for adding a prefix digit 1 before the number dialed by the caller. A second depression of the space bar selects ADD for PFX ADD CHK. This option tells the LCR-E that a digit 1 must be added before the number dialed by the caller. This option might be used when the trunk to which the call is being routed is an FX (foreign exchange) line that requires a digit 1 be dialed as a first digit (1+ dial area).

The displays to the right are provided for the options of NO or ADD on the PFX ADD CHK line.

In cases where the decision to add a prefix 1 is dependent on the CO (central office) exchange number dialed by the caller, a third depression of the space bar selects the option CHK (check). This option tells the LCR-E to check in an office code table to determine if the digit 1 should be added or not.

If this option is selected the display shown is provided.

**SAMPLE LCD INDICATIONS**

```

***ROUTE TABLE MODIFY***
TABLE NO. ? 120
TRK ACSS CODE : 01
AREA CODE DEL : DEL
ETR CODE ADD : ADD ETR CODE TBL: *
PFX ADD CHK : ***
SRV AREA CHK : ***
  
```

```

***ROUTE TABLE MODIFY***
TABLE NO. ? 120
TRK ACSS CODE : 01
AREA CODE DEL : DEL
ETR CODE ADD : ADD ETR CODE TBL:02
PFX ADD CHK : **
SRV AREA CHK : ***
  
```

```

***ROUTE TABLE MODIFY***
TABLE NO. ? 120
TRK ACSS CODE : 01
AREA CODE DEL : DEL
ETR CODE ADD : ADD ETR CODE TBL:02
PFX ADD CHK : NO
SRV AREA CHK : **
  
```

```

***ROUTE TABLE MODIFY***
TABLE NO. ? 120
TRK ACSS CODE : 01
AREA CODE DEL : DEL
ETR CODE ADD : ADD ETR CODE TBL:02
PFX ADD CHK : ADD
SRV AREA CHK : **
  
```

```

***ROUTE TABLE MODIFY***
TABLE NO. ? 120
TRK ACSS CODE : 01
AREA CODE DEL : DEL
ETR CODE ADD : ADD ETR CODE TBL:02
PFX ADD CHK : CHK OFC CODE TBL: **
SRV AREA CHK : **
  
```



**SAMPLE LCD INDICATIONS**

When the **CHK** option is selected it is necessary to also assign an office table number in which the LCR-E can check for a **flag**. Available table numbers are 000-127. Once the table number is assigned the cursor position automatically drops to the next line. If **NO** or **ADD** is selected, it is necessary to use the cursor down key to move to the next line.

```

***ROUTE TABLE MODIFY***
TABLE NO. ? 120
TRK ACSS CODE : 01
AREA CODE DEL : DEL
ETR CODE ADD : ADD ETR CODE TBL:02
PFX ADD CHK : CHK OFC CODE TBL:001
SRV AREA CHK : **
    
```

Service area check is an option used when the line to which the call is being routed is using an OCC and it is necessary to check for OCC service to a specific area based on the office code. This option allows the programmer to tell the LCR-E to refer to an office code table to determine whether service is available for that office.

```

***ROUTE TABLE MODIFY***
TABLE NO. ? 120
TRK ACSS CODE : 01
AREA CODE DEL : DEL
ETR CODE ADD : ADD ETR CODE TBL:02
PFX ADD CHK : CHK OFC CODE TBL:015
SRV AREA CHK : NO
    
```

Depress the space bar once to select **NO** for this option.

A second depression of the space bar selects the option **CHK** (check). This option tells the LCR-E to go check the office code table for a **flag** to determine if service is available for the office code dialed by the caller.

```

***ROUTE TABLE MODIFY***
TABLE NO. ? 120
TRK ACSS CODE : 01
AREA CODE DEL : DEL
ETR CODE ADD : ADD ETR CODE TBL:02
PFX ADD CHK : CHK OFC CODE TBL:015
SRV AREA CHK : CHK OFC CODE TBL:**
    
```

If the **CHK**(check) option is selected, it is necessary to enter an office code table number for the LCR-E to check. Available entries are 000-127. The example shows office code table number 100 assigned for service area check.

```

***ROUTE TABLE MODIFY***
TABLE NO. ? 120
TRK ACSS CODE : 01
AREA CODE DEL : DEL
ETR CODE ADD : ADD ETR CODE TBL:02
PFX ADD CHK : CHK OFC CODE TBL:015
SRV AREA CHK : CHK OFC CODE TBL:100
    
```

**NOTES:** 1. Each item in the route table must have an assignment made to it for the route table to be written into the computer. If any items are left unassigned the entire table remains unassigned.

2. If mistakes are made during the entry of data to this table, the use of the cursor keys allows moving the cursor to the item to be corrected and corrections can then be implemented.

3. When all data in the table is correct, depressing the **CR** (**RETURN**) causes the data to be entered into the computer memory and the display increments the table number by one. Depressing the return key will now allow programming of the next table. Prior to depressing the return key a second time, the programmer can enter a new table number to be modified.

4. When all route tables are assigned correctly, the use of the ESC key causes the data to be saved to the floppy disk and causes the display to return to the modify menu.

**f. Extra Code Table Modify**

Whenever the option of adding extra digits is selected in the route table assignment, an assignment to the extra code tables is required. This option allows the entry of up to 24 digits in a table which can be dialed out ahead of the number dialed by the caller. This option is provided for use mainly for when the line to which the caller is being connected is using an OCC (or SCC) and requires that extra digits be dialed (such as local number dialed and account code). This option can also be used for access to a PBX line where it is necessary to dial a PBX access code, or to tandem access a remote system's line(s) through a Tie line. The following procedure explains modification of the extra code tables.

With the Modify Menu in the display depress 6, then CR (RETURN).

Depress table number to be modified. Then CR (RETURN).

Now enter the number to be dialed ahead of the caller's number. Available entries are digits 0-9, #, \*, and the letter P for pause.

**NOTES:** 1. If mistakes are made during entry the cursor keys can be used to make corrections.

2. Once the desired digits are properly displayed, depressing the return key will enter the data into the computer's memory and increment the table number by one. Depressing the return key will now allow programming of the next table. Prior to depressing the return key a second time, the programmer can enter a new table number to be modified. When all extra code tables are assigned correctly, the use of the ESC key causes the data to be saved to the floppy disk and causes the display to return to the modify menu.

**SAMPLE LCD INDICATIONS**

\*\*\*EXTRA CODE TABLE MODIFY\*\*\*  
EXTRA CODE TABLE NO. ?

\*\*\*EXTRA CODE TABLE MODIFY\*\*\*  
EXTRA CODE TABLE NO. ? 11  
CODE ?

**g. Office Code Table Modify**

Whenever the option of either prefix check or service check is assigned in the route tables it is necessary to modify the office code tables for the LCR-E to check and determine how the call is to be processed.

Note that 128 office code tables are made available, and that these 128 tables are used for both prefix check and service area check. Normally these tables are used for either one check or the other, not both.

The following procedure shows how to modify the office code tables as required. With the Modify Menu in the display depress 7, then CR (RETURN). The display shown will be provided.

Now enter the table number to be modified, then CR (RETURN). Available entries are 000-127. The example at right shows table 010 chosen.

Now enter the office code number to be modified. Available entries are 200-999. The example shows 201.

The display will appear as a grid showing the entry of 0 or 1 in the position for up to 50 office codes. To the left of the grid is displayed the starting number for each row of the office codes. Across the top of the grid is provided columns 0-9 which correspond to the last digit of the office code on any line.

For example, to find the office code position for 201 in the display above locate the number 200 and look to the right under the column labelled 1. The crosspoint between row 200 and column 1 is the position corresponding to 201.

The cursor will be positioned at the office code that was chosen in the step above.

Two methods are now available for changing the assignment in the office code table. Depressing a 0 or 1 as required will enter that number into the display. Depressing the space bar causes the cursor position displayed to alternate between 0 and 1 or 1 and 0.

Using the cursor keys allows the programmer to move around the grid to change any desired office code position.

The significance of the 0 or 1 depends on the type of assignment made in the route tables for this office code table, either prefix check or service area check.

**SAMPLE LCD INDICATIONS**

```

***OFFICE CODE TABLE MODIFY***
TABLE NO. ? 
  
```

```

***OFFICE CODE TABLE MODIFY***
TABLE NO. ? 010
OFC CODE ? 
  
```

```

***OFFICE CODE TABLE MODIFY***
TABLE NO.? 010      0  1  2  3  4  5  6  7  8  9
OFC CODE ? 201    1  1  1  1  1  1  1  1  1  1
                  210    1  1  1  1  1  1  1  1  1  1
                  220    1  1  1  1  1  1  1  1  1  1
                  230    1  1  1  1  1  1  1  1  1  1
                  240    1  1  1  1  1  1  1  1  1  1
  
```

They are as follows:

- |                    |   |  |
|--------------------|---|--|
| Prefix area check  | 0 | Add the prefix 1 to the number dialed. |
|                    | 1 | Do not add the prefix 1.               |
| Service area check | 0 | Service is not available.              |
|                    | 1 | Service is available.                  |

**SAMPLE LCD INDICATIONS**

**NOTES:** 1. When all changes are made to the grid, using the return key will cause the data to be entered into the computer's memory and the display will show the starting position of the next 50 office codes. Depressing return again causes the next 50 codes to be displayed. Prior to depressing the return key the second time the programmer may choose a new office code to jump to.

2. When all changes are made to all office codes as desired the use of the ESC key causes the data to be saved to the floppy disk and returns the display to the Modify Menu.

**h. Home NPA Code Modify**

For purposes of allowing the LCR option to be applied properly to local calls it is necessary to input the local area code number into the Home NPA code table. For use of LCR on local calls the LCR-E will temporarily insert the Home NPA code ahead of the number dialed to allow it to route through the area code table and on to the different routes.

The following procedure describes modification of the Home NPA code table.

With the Modify Menu in the display depress 8, then CR (RETURN). The display shown will be provided.

Now type in the numbers corresponding to the local area code in which the system is installed.

Depress return to enter the data into the computer's memory.

Depress the ESC key to enter the data into floppy disk and return the display to the Modify Menu.

Depress the ESC key to return the display to the LCR main menu.

\*\*\*HOME NPA CODE MODIFY\*\*\*  
HOME NPA CODE :

\*\*\*HOME NPA CODE MODIFY\*\*\*  
HOME NPA CODE : 516

## 5. Display Mode

The display mode function is made available at the LCR Main menu. This function allows the programmer to view the data available in any of the tables in the floppy disk. This function does not allow the programmer to change data, just look at it. As this function only allows viewing data from the floppy disk, the programmer may decide to up load data from the LCR-E to the floppy disk (before using this option) if it is desired to view the contents of the present data in the LCR-E.

The following pages show the steps required to properly use the display mode function.

The first step in using the display mode function is to make sure that the LCR MAIN MENU is in the display of the computer. While at the LCR Main Menu, depress 5, then the return key.

The program for the display function is loaded from the floppy disk and the display at right is provided.

This is the Display Menu. The Display Menu allows the programmer to choose any table for viewing. The normal sequence of operation within the display mode is to select a number from the display. After entering the selection number, depress the return key. This causes the computer to load the data from the floppy disk into the computer memory. Once this is done a display is provided which requests the table number to be viewed. Within the area code tables an area code must also be entered. The office code tables also require an additional entry. After this information is entered into the computer the display mode function displays the contents of the requested table.

Once the table has been viewed the programmer depresses return and the table number in the display is incremented by one and the contents of the new table may be viewed. Use of the cursor up key allows moving to the table number position and selecting a different table for viewing. If this is done, depressing the return displays the new table.

After all desired tables have been viewed, depress the ESC key to return to the Display Menu. A new table type can be selected and further viewing is possible.

## SAMPLE LCD INDICATIONS

```
***DISPLAY***
1 AREA CODE TABLE      6 EXTRA CODE TABLE
2 WEEKLY SCHEDULER     7 OFFICE CODE TABLE
3 DAILY SCHEDULER      8 HOME NPA CODE
4 ROUTE ADVANCE
5 ROUTE TABLE
ENTER MENU NO. 
```

Use of the ESC key while in the Display Menu CR (RETURN) the display will bring to the LCR Main Menu.

Below and in the following pages is provided an example of the display mode as applied to each table type selection.

a. Area Code Table Display

While in the Display Menu depress 1, then the CR (RETURN) key. The display shown is provided:

```
***AREA CODE TABLE DISPLAY***
TENANT NO. ? 
```

Enter the Tenant number (1-3) desired, then the CR (RETURN) key.

```
***AREA CODE TABLE DISPLAY***
TENANT NO ? 1
AREA CODE ? 
```

Enter the desired area code, then depress the CR (RETURN) key.

```
*** AREA CODE TABLE DISPLAY***
TENANT NO      ? 1
AREA CODE      ? 223
TABLE NAME     : WEEKLY
TABLE NO.      : 02
```

The content of the desired area code table is now displayed.

b. Weekly Schedule Table Display

NOTES: 1. Use of the ESC key returns the display to the Display Menu.

2. Use of the CR (RETURN) key causes the displayed area code to be incremented by one and displays the contents of the new table.

3. Use of the cursor up key allows moving the cursor back to the table number position and changing it to a new number. Depress CR (RETURN) to view the new table.

c. Daily Schedule Table Display

While in the Display Menu depress 3, then the CR (RETURN) key. The display at right is provided:

```
***DAILY SCHEDULE DISPLAY***
DAILY SCHEDULE TABLE NO.? 
```

Enter the desired table number (00-63) then the CR (RETURN) key.

```
*** DAILY SCHEDULE DISPLAY ***
DAILY SCHEDULE TABLE NO.? 01
0 1 2 3 4 5 6 7 8 9 10 11
02 ** ** ** ** ** ** ** ** ** ** ** ** ** **   05 05 ** **
12 13 14 15 16 17 18 19 20 21 22 23
** ** ** ** ** ** ** ** ** ** ** ** ** ** ** ** ** ** **   ** ** ** ** **
```

NOTES: 1. Use of the ESC key returns to the Display Menu.

2. If desired, successive depressions of the CR (RETURN) key allows viewing of consecutive tables.

SAMPLE LCD INDICATIONS

3. Use of the cursor up key allows moving the cursor back to the table number position and changing it to a new number. Then depress CR (RETURN) to view the new table.

d. Route Advance Table Display

While in the Display Menu depress 4, then the CR (RETURN) key. The display shown is provided:

```
***ROUTE ADVANCE DISPLAY***
ROUTE ADVANCE TABLE NO.? 
```

Enter the desired table number (00-63) then depress the CR (RETURN) key.

```
***ROUTE ADVANCE DISPLAY***
ROUTE ADVANCE TABLE NO.? 
1ST ROUTE TABLE NO. : 208
2ND ROUTE TABLE NO. : 209
3RD ROUTE TABLE NO. : 210
4TH ROUTE TABLE NO. : 211
```

NOTES: 1. Use of the ESC key returns to the Display Menu.

2. If desired, successive depressions of the CR (RETURN) key allows viewing of consecutive tables.

3. Use of the cursor up key allows moving the cursor back to the table number position and changing it to a new number. Depress CR (RETURN) to view the new table.

e. Route Table Display

While in the Display Menu depress 5, then the CR (RETURN) key. The following display is provided:

```
***ROUTE TABLE DISPLAY***
TABLE NO. ? 
```

Enter the desired table number (000-255) then depress the CR (RETURN) key.

```
***ROUTE TABLE DISPLAY***
TABLE NO. ? 
TRK ACSS CODE : 02
AREA CODE DEL : NO
ETR CODE ADD : ADD ETR CODE TBL : 12
PFX ADD CHK : CHK OFC CODE TBL : 127
SRV AREA CHK : CHK OFC CODE TBL : 126
```

NOTES: 1. Use of the ESC key returns to Display Menu.

2. If desired, successive depressions of the CR (RETURN) key allows viewing of consecutive tables.

3. Use of the cursor up key allows moving the cursor back to the table number position and changing it to a new number. Depress CR (RETURN) to view the new table.

SAMPLE LCD INDICATIONS

f. Extra Code Table Display

While in the Display Menu depress 6, then the CR (RETURN) key. The following display is provided:

Enter the desired table number (00-15) then depress the CR (RETURN) key.

NOTES: 1. Use of the ESC key returns to the Display Menu.

2. If desired, successive depressions of the CR (RETURN) key allows viewing of consecutive tables.

3. Use of the cursor up key allows moving the cursor back to the table number position and changing it to a new number. Then depress CR (RETURN) to view the new table.

g. Office Code Table Display

While in the Display Menu depress 7, then the CR (RETURN) key. The display shown is provided:

Enter the Table number (000-127) desired, then the CR (RETURN) key.

Enter the desired office code, then depress the CR (RETURN) key. The status of 50 office codes (including the selected one) is now displayed.

NOTES: 1. If it is desired to change the table or office codes being viewed, use the cursor up key to return to the office code or table number position, where a new table number and/or new office code can be entered. Then depress the CR (RETURN) key.

2. Depressing the CR (RETURN) key causes the table number to be incremented by one and displays the contents of the new table.

**SAMPLE LCD INDICATIONS**

```
***EXTRA CODE TABLE DISPLAY***
EXTRA CODE TABLE NO. ? 
```

```
***EXTRA CODE TABLE DISPLAY***
EXTRA CODE TABLE NO. ? 03
CODE ? P03*434*0941
```

```
***OFFICE CODE TABLE DISPLAY***
TABLE NO. ? 
```

```
***OFFICE CODE TABLE DISPLAY***
TABLE NO. ? 100
OFC CODE ? 
```

```
***OFFICE CODE TABLE DISPLAY***
TABLE NO.? 100      0 1 2 3 4 5 6 7 8 9
OFC CODE ? 200    200  1 1 1 1 1 1 1 1 1
                  210  1 1 1 1 1 1 1 1 1 1
                  220  1 1 1 1 1 1 1 1 1 1
                  230  1 1 1 1 1 1 1 1 1 1
                  240  1 1 1 1 1 1 1 1 1 1
```



3. Use of the ESC key returns to the Display Menu.

h. Home NPA Code

While in the Display Menu depress 8, then the CR (RETURN) key. The display shown is provided:

**SAMPLE LCD INDICATIONS**

\*\*\*HOME NPA CODE DISPLAY\*\*\*  
HOME NPA CODE; ?904

**NOTE:** Once the home NPA code is viewed the only option available is to depress the ESC key and CR (RETURN) to the Display Menu.

**6. PRINT OUT MODE**

The option of obtaining a hard copy of the table data is made available using the PRINT OUT Menu chosen from LCR Main Menu. The data printed out is the information presently stored on the floppy disk. The following steps allow the programmer to obtain a print out of any table data.

With the LCR Main Menu in the display, depress 6, then depress CR (RETURN). The display shown is provided:

\*\*\*PRINT OUT\*\*\*  
1 AREA CODE TABLE      6 EXTRA CODE TABLE  
2 WEEKLY SCHEDULE      7 OFFICE CODE TABLE  
3 DAILY SCHEDULE      8 HOME NPA CODE  
4 ROUTE ADVANCE  
5 ROUTE TABLE  
ENTER MENU NO.

Select the number of the desired table, then depress CR (RETURN). The example shows the display provided if option 1 (Area Code) is selected.

AREA CODE TABLE PRINT OUT START

If 7 (OFFICE CODE TABLE) is selected, two additional steps are required.

With the PRINT OUT MODE in the display, depress 7, then CR (RETURN). The display to the right is provided.

\*\*\*OFFICE CODE TABLE PRINT\*\*\*  
TABLE NO. FROM

1. Input the starting table number and CR (RETURN).

2. Input the end table number and CR (RETURN).

**NOTES:** 1. The display is an example of area code data being printed out from the floppy disk. The blocked off area is replaced with the name of the table chosen, but otherwise looks the same for all other selections.

\*\*\*OFFICE CODE TABLE PRINT\*\*\*  
TABLE NO. FROM 100  
TO

2. Depress CR (RETURN) to go back to the Print Out display.

HOME NPA CODE TABLE PRINT OUT START  
NORMAL END ←

If no problem is encountered during the printout process the display shown is provided.

### SAMPLE LCD INDICATIONS

If a problem is encountered during the printout process, the display shown is provided.

HOME NPA CODE TABLE PRINT OUT START  
ABNORMAL END ←

**NOTES:** 1. In the example, the blocked off area is replaced with the name of the table chosen.

2. Refer to the table of errors (elsewhere in this chapter) for further guidance if a problem is encountered.

3. Use of the ESC key returns the display to the LCR Main Menu from the Print Out Menu.

#### **7. SYSTEM DATA CLEAR**

When major changes to the floppy disk data are required, the option is provided at the LCR Main Menu to clear out data on a table basis. The following steps provide the procedures for using this option.

With the LCR Main Menu displayed, depress 7, then CR (RETURN). The display shown is provided:

\*\*\*SYSTEM DATA CLEAR\*\*\*  
1 AREA CODE TABLE      6 EXTRA CODE TABLE  
2 WEEKLY SCHEDULER    7 OFFICE CODE TABLE  
3 DAILY SCHEDULER      8 HOME NPA CODE  
4 ROUTE ADVANCE  
5 ROUTE TABLE  
ENTER MENU NO.   

Enter the number of the table to be cleared and depress CR. (RETURN). The example shows the display for selection 1 (area code table clear).

AREA CODE TABLE DATA CLEAR START   

If no problem is encountered during the clearing process the display shown is provided.

AREA CODE TABLE DATA CLEAR START  
NORMAL END ←

If a problem is encountered during the clearing process the display shown is provided.

AREA CODE TABLE DATA CLEAR START  
ABNORMAL END  
FDD I/O ERROR ←

Depress CR (RETURN) key to go back to the System Data Clear Menu.

**NOTES:** 1. The displays shown are typical of what may be seen during the clearing process. The blocked off area is replaced with the name of the selected table name. Due to the large memory used in the office code table, when it is cleared the display will show darkened cursor blocks to indicate the progress of the clearing process.

2. At the end of the clearing process depress CR (RETURN) to get back to the System Data Clear Menu.

3. Refer to the table of errors (elsewhere in this chapter) for further guidance if a problem is encountered.

### 8. SYSTEM CONTROL MODE

The LCR Main Menu provides an option to restart the LCR-E. This option is made available to allow resetting the LCR-E without affecting the rest of the system (in other words a CPU-E( ) reset is not necessary to reset the LCR-E). Under normal conditions this option is not to be used.

To use this option the following procedure is required.

With the LCR Main Menu in the display, enter 10, then depress RETURN. The display shown is provided.

If no problem is encountered during the restarting process the display shown is provided.

If a problem is encountered during the restarting process the display shown is provided.

**NOTE:** Once the restarting process is completed depress CR (RETURN) to get back to the LCR Main Menu.

### SAMPLE LCD INDICATIONS

PHASE EXECUTING

PHASE EXECUTING  
NORMAL END ←

PHASE EXECUTING  
ABNORMAL END  
LINE TROUBLE ←

### 750.9 Error Messages

This section is provided to assist the programmer in understanding the possible error indications provided by the LCR support equipment.

This section is divided into two parts. The first part provides an example of each error display. The second part is a table which provides the following:

- a. Listing of error
- b. Reason for error
- c. Possible solution(s) for each error
- d. The Command Mode during which the error may occur.

#### 750.9.1 PC-8300 and Associated Equipment Troubles

##### 1. Line Trouble

When the line (connection) to the LCR-E is faulty, a display similar to the one shown will be provided:

```
AREA CODE TABLE DOWN LOAD START  
ABNORMAL END  
LINE TROUBLE ←┘
```

##### 2. Floppy Disk I/O Error

When the computer cannot communicate properly with the Disk Drive Unit, a display similar to the one shown is provided:

```
SYSTEM DATA SAVING  
FDD I/O ERROR ←┘
```

##### 3. Printer Output Error

When the printer does not indicate to the computer that it is ready to receive data, a display similar to the one shown is provided:

```
EXTRA CODE TABLE PRINT OUT START  
ABNORMAL END  
PRINTER NOT READY ←┘
```

#### 750.9.2 LCR-E Status Indications

##### 1. LCR Restart

Should the LCR-E restart during a transfer of data between the computer and the LCR-E (other than during a System Control command), a display similar to the one shown will be provided:

```
AREA CODE TABLE DOWN LOAD START  
ABNORMAL END  
LCR RESTARTED ←┘
```

### SAMPLE LCD INDICATIONS

**SAMPLE LCD INDICATIONS**

**2. Insufficient Data**

If an LCR program was created which does not produce enough information to allow Call Routing, when this program is transferred from the LCR-E to the computer a display similar to the one shown is provided:

```
ROUTE ADVANCE TABLE DOWN LOAD START
ABNORMAL END
SYS. DATA INCOMPLETE ←┐
```

**3. Electra MarkII Not Ready**

If the computer is unable to communicate with the LCR-E a display similar to the one shown is provided:

```
AREA CODE TABLE DOWN LOAD START
ABNORMAL END
LCR RESTARTED ←┐
```

During the input of data or commands, if an invalid input is keyed in the computer, it will generate a beep tone to indicate that an invalid command or data was entered.

Table 750-1 Error Table

ERROR	REASON	POSSIBLE SOLUTION	COMMAND MODE
Line Trouble	LCR-E ETU and PC8300 Disk Drive not communicating properly.	Check RS-232C cable. Verify cable connections. Ensure LCR-E ETU Busyout switch is ON.	Down Load Up Load Verify System Control
FDD I/O Error	PC-8300 and disk drive not communicating properly	Check cable between PC-8300 and Disk Drive. Check power on Disk Drive. Check for properly inserted diskette. Check that diskette write protect tab is set properly.	All commands except System Control
Printer Not Ready	PC-8300 cannot communicate with printer	Check connections to printer. Check printer power. Check that printer is ON LINE. Check paper feed.	Print Out
LCR Restarted	LCR-E restart during command associated with LCR-E.	Replace LCR-E.	Down Load Up Load Verify System Control
System Data Incomplete	Insufficient Data received from LCR-E	Check LCR Program. Down Load all Tables. Replace LCR-E	Down Load
Key System Not Ready	Invalid data or no data from LCR-E	Check LCR-E switch settings. If settings are right, replace LCR-E.	Down Load
Beep Tone	Invalid input keyed in.	Check cursor position to determine required input and enter valid entry.	All command modes

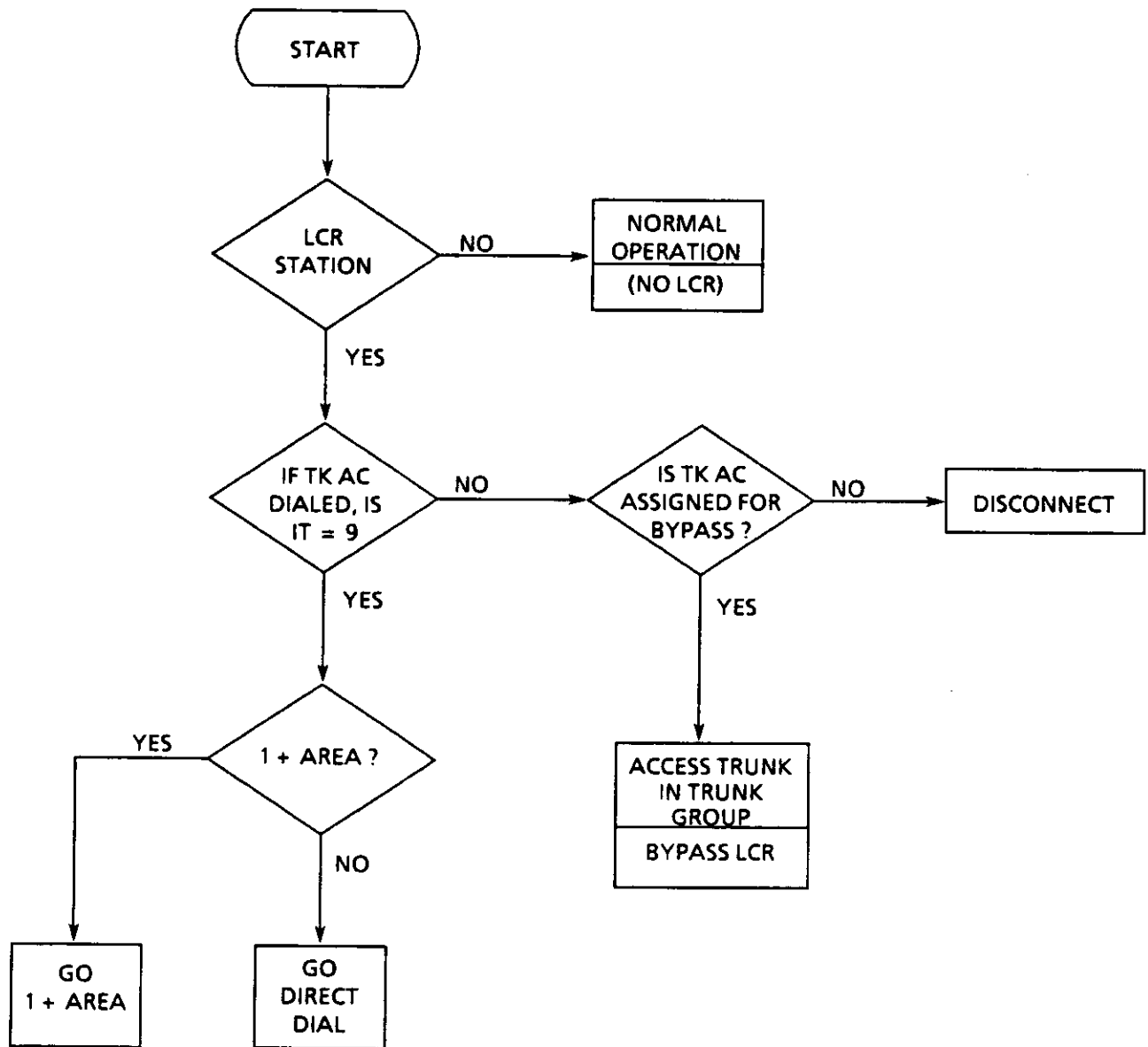

NOTE: Normal operation indicates that a trunk will be accessed from the 9 Access Code Group.

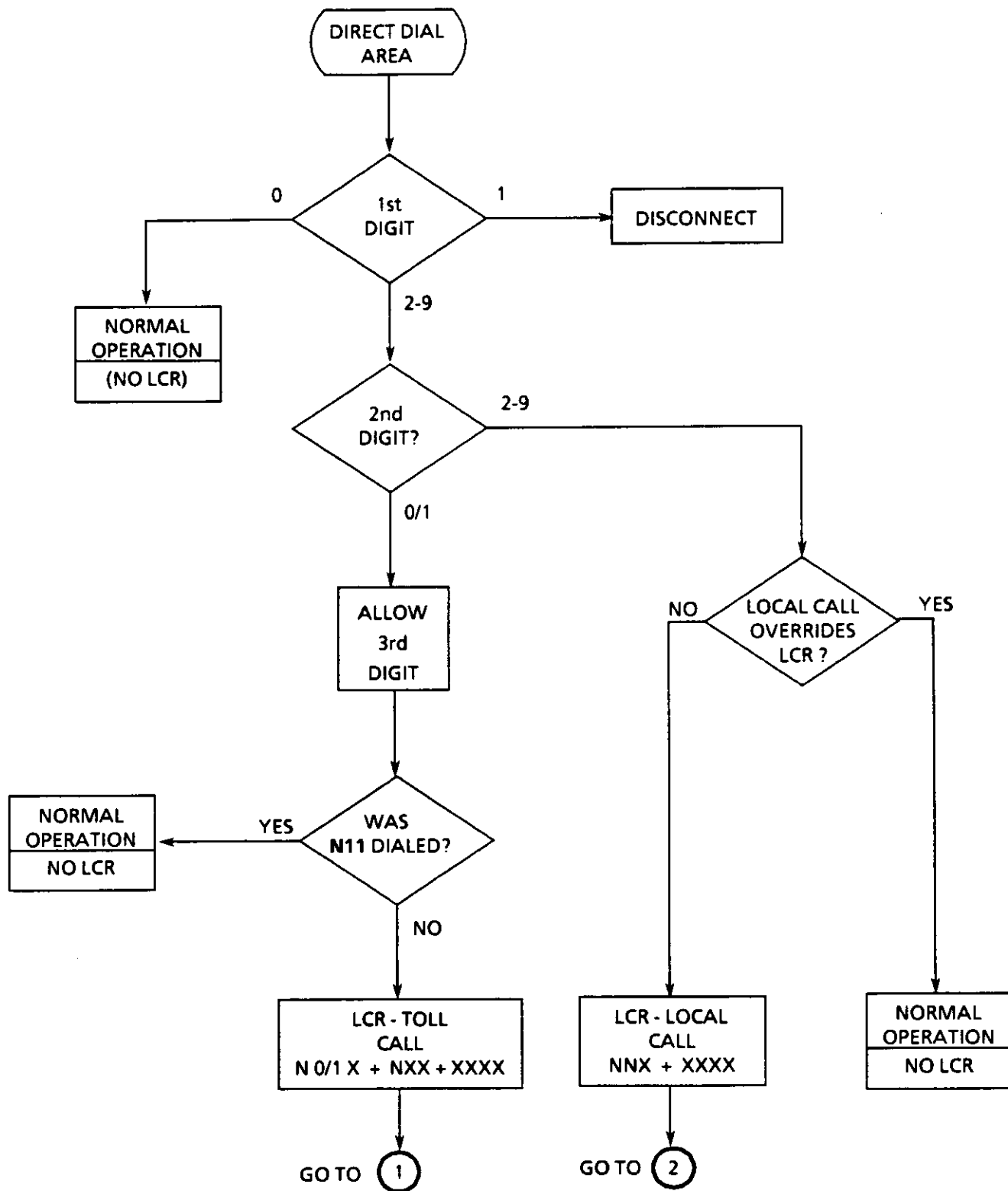

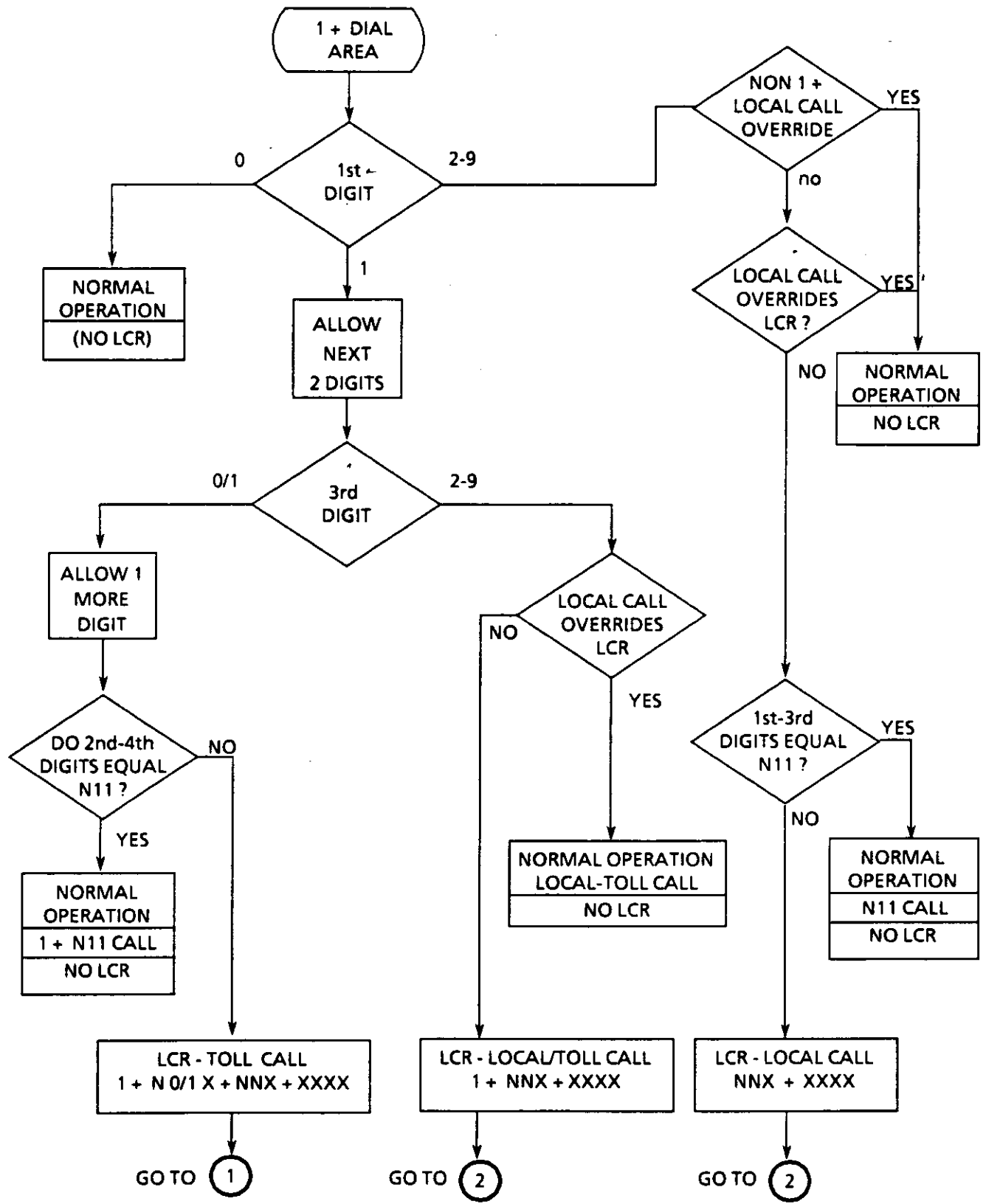

X = 0-9  
 N = 2-9



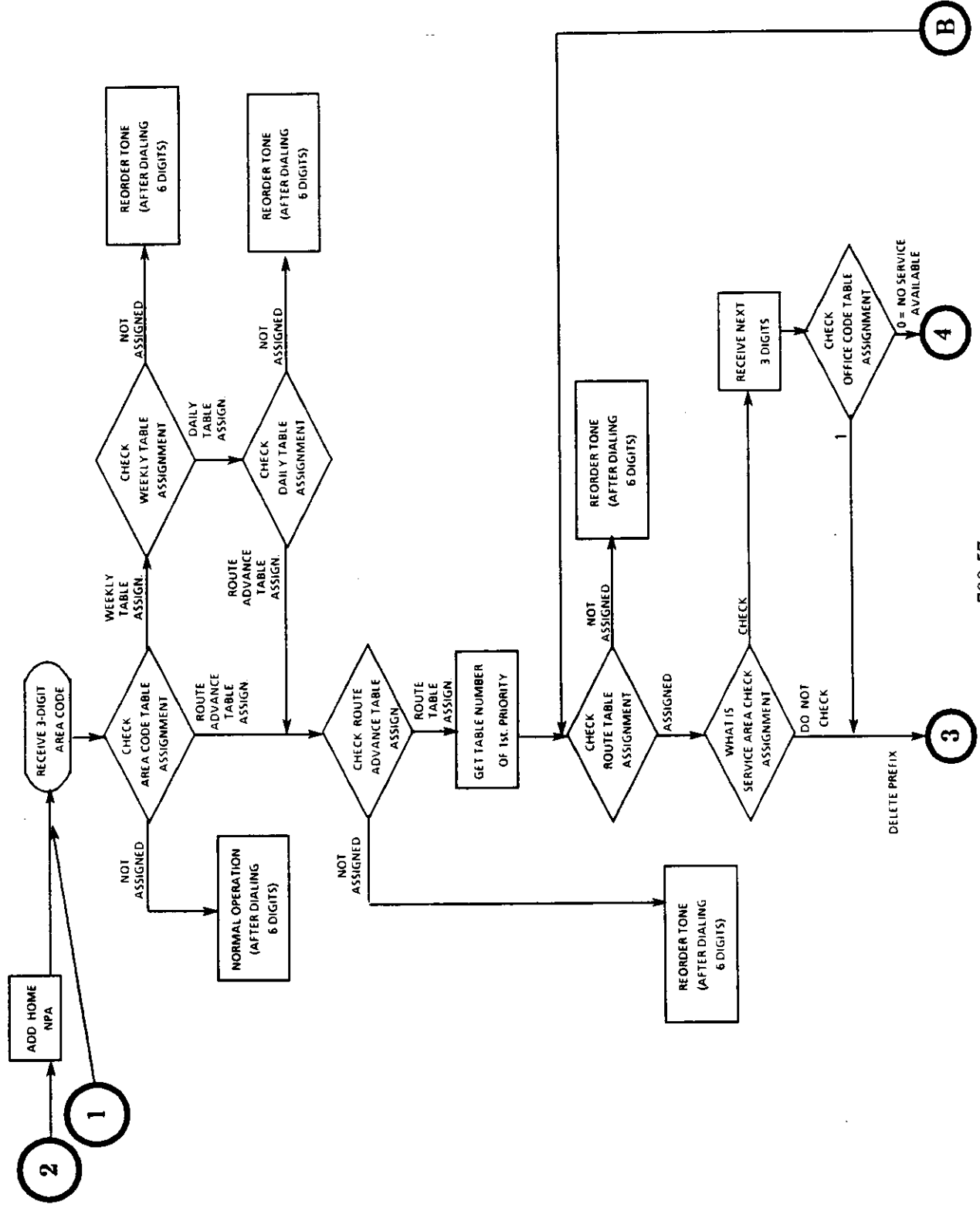

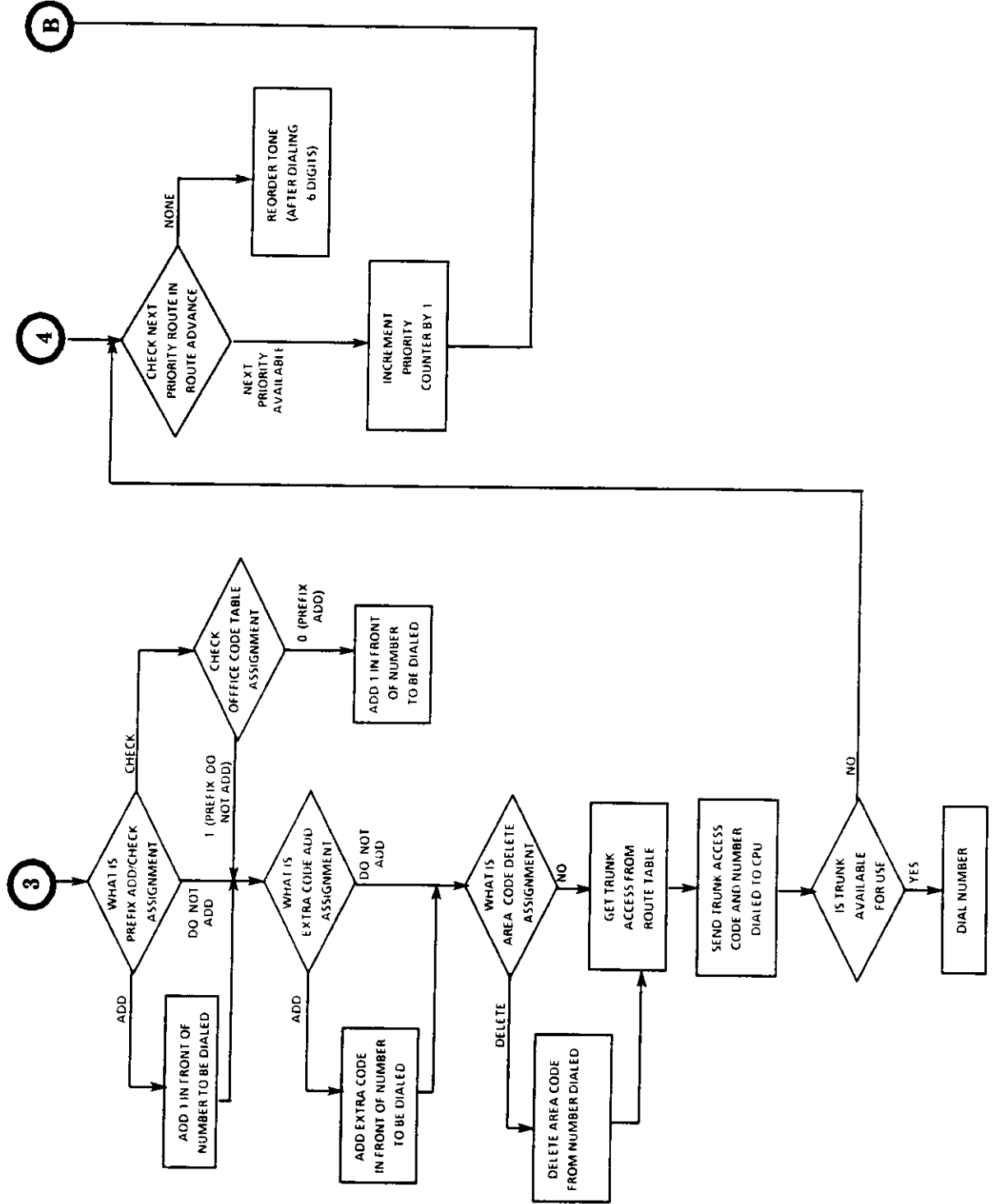



## AREA CODE TABLES

### DESCRIPTION

### ENTRY

Tenant Number

1 ~ 3

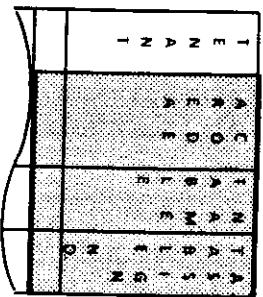

Area Code

2X0 ~ 9X9  
 X = 0 or 1

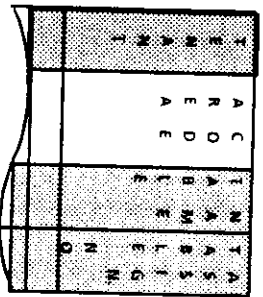

Table Name (Route Advance or Weekly Assignment)

R (Route Advance)  
 W (Weekly)

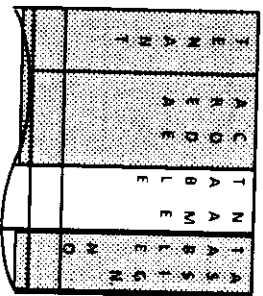
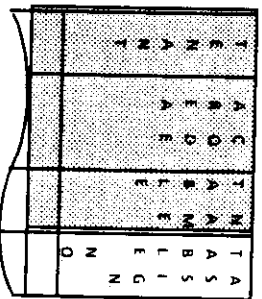

Table Number Assignment

00 ~ 63





**DAILY SCHEDULE TABLE**  
**DESCRIPTION**

					00	01	02	03	04	05					
T A B L E															

Daily Schedule Table  
 Number Being Assigned

**ENTRY**  
 00 ~ 63

					00	01	02	03	04	05					
T A B L E															

Hourly Assignment (Entry  
 of Route Advance Table)

00 ~ 63



## ROUTE ADVANCE TABLES

### DESCRIPTION

### ENTRY

00 ~ 63

Route Advance Table  
 Number Being Assigned

TABLE NUMBER	1st ROUTE	2nd ROUTE	3rd ROUTE	4th ROUTE

Route Advance Priority Assignments  
 (Assigned Route Tables)

000 ~ 255

TABLE NUMBER	1st ROUTE	2nd ROUTE	3rd ROUTE	4th ROUTE



# NEC ENGINEERING TECHNICAL INFORMATION

**Electra markII**

ETI NUMBER: MK-003  
DATE: JULY 7, 1987

## GENESIS GENIE VOICE MAIL SYSTEM CONNECTION PROCEDURE

### 1. DESCRIPTION

This Engineering Technical Information (ETI) Bulletin describes the procedure for connecting the Genesis GenieVoice Mail System to the Electra MarkII system via the VMI-E ETU.

**NOTE:** Before undertaking this procedure, the installer should be familiar with the Genesis Genie, Technical reference manual and Chapter 8 of the Electra MarkII Installation Service Manual.

### 2. PARTS REQUIRED

- 2.1 VMI-E ETU (An MFR-EA ETU and an RSG-E unit associated with the CCU in which the VMI-E ETU is installed are also required).
- 2.2 Genesis GenieVoice Mail System (Including the Technical Reference Manual and the System Managers Guide).
- 2.3 A serial computer terminal (The NEC PC8201A or PC8300 portable computers are recommended).
- 2.4 RS232C Null Modem cable (Pins 2 and 3 reversed).
- 2.5 Modular Line Cords (2), RJ11C/W connectors and cable.

### 3. OPERATION

After installation and programming are completed, users of the Electra MarkII will be able to access the Genie system from any internal extension either by Hunt Group Access (Default Code 63) or by dialing one of the VMI extensions directly.

Once a call is placed into the Genie system, the user is directed by the audible menu prompts of the Genie on how to access the various features available. For a complete explanation of the features available with the Genesis Genie Voice Mail System, refer to the Genie System User's Guide and System Manager's Guide.

### 4. PROCEDURE

- 4.1 Connection
  - 4.1.1 Install the VMI-E ETU in an available interface slot, in a CCU which is supported by an RSG-E unit.

- 4.1.2 The Genie Voice Mail System provides two ports (AIUs) for Voice Mail Access. These ports connect to two (of the four available) VMI-E extension positions. These VMI-E extensions should be cross-connected from the appropriate J block on the MDF and connected to an RJ11C connector to facilitate connection to the Genie using modular line cords (See Figure 1).

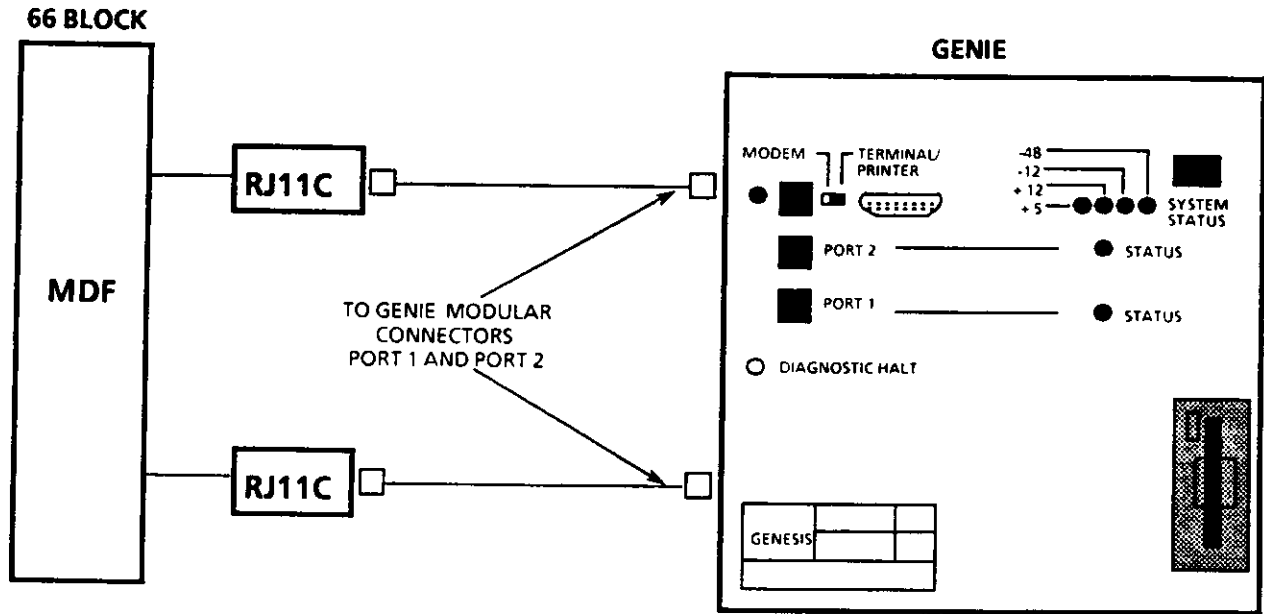

Figure 1. Genie Connection Block Diagram

## 4.2 Electra MarkII System Programming

- 4.2.1 If the VMI-E ETU is being added to an existing system in an interface slot previously occupied by a different type of ETU, it is necessary to assign the interface slot to be used for the VMI-E ETU in Memory Block 4C1. (Refer to Chapter 3 of the Installation/Service Manual).
- 4.2.2 The two voice mail extensions connected to the Genie System can be programmed in the Voice Mail Hunt Group in Memory Block 2C4. (Refer to Chapter 3 of the Installation/Service Manual).

## 4.3 Installing/Initializing Genie

**NOTE:** Ensure both the Genie and the computer terminal power switches are turned off.

- 4.3.1 Configure the serial computer terminal to be used with the Genie as follows:
- 8-bit word length
  - no parity (ignore parity on some terminals)
  - 1 stop bit
  - auto-line feed off
  - full duplex
  - 1200 baud

- 4.3.2 Connect the terminal to Genie RS232C cable connector using an RS232C null modem cable (pins 2 and 3 reversed) and ensure the switch is set to **TERMINAL/PRINTER** (See FIGURE 1).
- 4.3.3 Apply power to the terminal.
- 4.3.4 Apply power to the Genie (The System Diagnostic message should appear on the terminal).
- 4.3.5 Refer to the Genie Technical Reference Manual for setup information.

**NOTE:** Genie BAUD Rate Settings

The Genie RS232C port is pre-set for 1200 baud. If the terminal being used cannot be configured for 1200 baud, Genie's baud rate can be changed to 300, 2400 or 9600 as follows:

- Remove Genie's top cover by removing four (4) screws (two on top and two on the bottom).
- Remove Genie's front cover (shown in Figure 1) by removing four (4) screws (two on top and two on the bottom) holding the cover in place and the two HEX screws securing the RS232C connector to the front cover.
- Locate the CPU card ( the lowest PCB with two ribbon cables attached).
- Disconnect the two ribbon cables from the CPU card.
- Remove the CPU card. **HANDLE THE CPU CARD BY THE EDGES ONLY.**
- Locate the Baud Rate Jumper Block #2 on the CPU card (near the ribbon cable connectors).
- Move the jumper to the desired baud rate setting.

JUMPER LOCATION MARKING	BAUD RATE SELECTION
96	9600
48	300
24	2400
12	1200

- Reinstall the CPU card. **Again, be careful to handle the CPU by the edges only.**
- Reconnect the two ribbon cables to the CPU card.
- Replace the front and top covers.

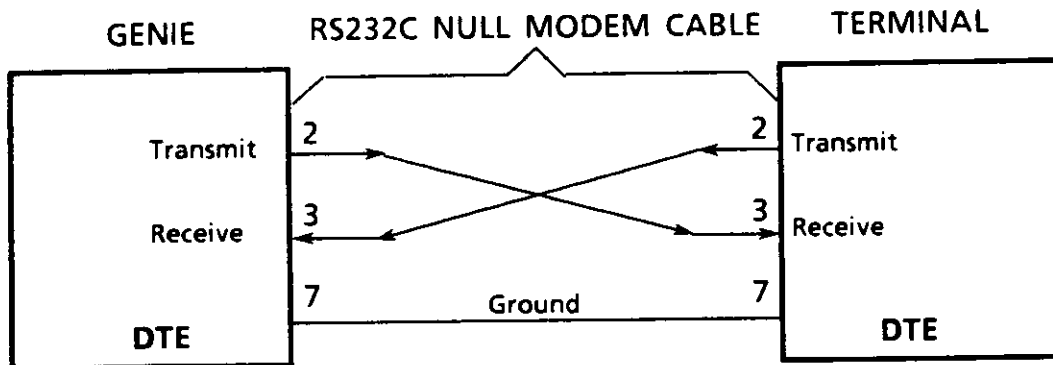

Figure 2. RS232C Communications Terminal Interface



**CHAPTER 8**  
**VOICE MAIL INTERFACE**



## CHAPTER 8 VOICE MAIL INTERFACE

### TABLE OF CONTENTS

SECTION	DESCRIPTION	PAGE
810	GENERAL	800-1
820	SPECIFICATIONS	
820.1	General Information	800-1
820.2	Signaling Parameters	800-1
820.3	Additional Functions	800-1
820.4	Hardware Requirements	800-2
820.5	Hardware Installation	800-2
830	PROGRAMMING	
830.1	Required Programming	800-2
830.2	Recommended Programming	800-2

#### SECTION 810 GENERAL

The Voice Mail Interface ETU (VMI-E) provides the Electra Mark II system with the ability to support selected Voice Mail equipment.

Depending on the type of Voice Mail equipment and the method of connection, a greater or lesser degree of integration is provided.

The VMI-E ETU will support, (when used with Voice Mail equipment that provides these features):

- Access to a Voice Mail system via Hunt Group.
- In-Band Voice Mail Message Waiting Indications (Set and Cancel).
- Call placement by the Voice Mail System.

#### SECTION 820 SPECIFICATIONS

##### 820.1 GENERAL INFORMATION

The VMI-E ETU provides four (4) discrete, two-way communication channels which are used for interfacing Voice Mail equipment. Each VMI-E

channel is equipped with a DTMF encoding circuit which sends DTMF signaling to the Voice Mail equipment. This DTMF signaling allows telephones within the system to communicate with the Voice Mail equipment via dial pad.

##### 820.2 SIGNALING PARAMETERS

Depending on the signaling requirements of the Voice Mail equipment being installed, signal timing parameters can be independently assigned to each of the four VMI-E channels by programming of the Electra Mark II system.

**NOTE:** Dial Pulse (Rotary) Signaling is not supported by the VMI-E ETU.

##### 820.3 ADDITIONAL FUNCTIONS

In addition to voice path and signaling functions, the VMI-E ETU provides ringing signal control and a path to an MFR-E ETU. This allows certain Voice Mail equipment to dial internally, to access outside lines for Voice Message delivery (call placement), as well as the setting and cancelling of Message Waiting indication using in-band DTMF signaling.

##### NOTES:

A. The VMI-E ETU is designed to pass 2 or 3 digit access codes from the Voice Mail Equipment, for handling Voice Message Waiting Indications.

B. The Voice Mail equipment must be capable of providing two different access codes, followed by the extension number of the associated station. One code is used for setting the Message Waiting indication, while the second code is used to cancel the message indication.

C. Default Voice Mail Message Waiting access codes are 541 and 54\* to set and cancel the Message Waiting indication, respectively.

##### 820.4 HARDWARE REQUIREMENTS

Connection of Voice Mail equipment to the Electra Mark II system requires a VMI-E ETU and an RSG-E unit that supports the CCU in which the VMI-E ETU is installed.





If the Voice Mail equipment to be connected provides call placement and/or in-band message wait signaling capability, an MFR-E ETU is also required. The RSG-E unit and the MFR-E ETU may be shared with single line telephones installed in the system.

NOTE: No more than 1 VMI-E ETU can be installed in a system.

### 820.5 HARDWARE INSTALLATION

The VMI-E ETU can be installed in any interface slot of the Electra Mark II system that is supported by an RSG-E unit. (Refer to Chapter 2 of this manual for more information on hardware installation).

## 830 PROGRAMMING

### 830.1 REQUIRED PROGRAMMING

MEMORY BLOCKS 4B8 and 4B9; are used to assign signal timing parameters to each channel of the VMI-E ETU.

Refer to the specifications of the Voice Mail equipment being connected to determine any changes necessary for proper operation. Engineering Technical Information (ETI) bulletins are issued to assist in the connection of specific Voice Mail equipment.

MEMORY BLOCK 4C1 - CARD INTERFACE SLOT ASSIGNMENT; can be used to assign interface cards (in this case, the VMI-E ETU) to the various CCU interface slots.

When installing a VMI-E ETU in a vacant interface

slot (not previously assigned) before initial power up, no additional programming of this memory block is required. However, if the VMI-E ETU is added to an existing system, into an interface slot previously occupied by a different type ETU, it will be necessary to reassign the CCU interface slot, using this memory block, after the VMI-E ETU has been installed.

**830.2 RECOMMENDED PROGRAMMING**  
**MEMORY BLOCK 1C3 - DSS/BLF BUTTON ASSIGNMENT;** It is recommended that VMI-E extension appearances be programmed onto the attendant's DSS/BLF to permit easy access for calls and transfers to the Voice Mail equipment.

NOTE: Before programming Memory Block 1C3, Memory Block 1C1 - DSS/BLF TO ATTENDANT ASSIGNMENT should already be programmed; as any change made to this memory block will erase any previous assignments made in Memory Block 1C3, and will have to be reentered.

MEMORY BLOCK 2C4 - VOICE MAIL HUNT GROUP ASSIGNMENT; is used to assign up to four VMI extension numbers to the Voice Mail hunt group. After this is done, when the Voice Mail Hunt Group Access Code (Default "63") is dialed, the system will hunt for the first idle extension within the hunt group.

MEMORY BLOCK 3C1 - TELEPHONE NAME ASSIGNMENT; can be used to assign a name to each VMI-E channel. When Message Waiting displays are sent from a Voice Mail system, this name will be included in the Message Display that is sent to any key telephone with a display (Example: "MAIL").

Table 1. VMI-E Signal Timing Parameters (Memory Blocks 4B8 and 4B9)

PARAMETER	MINIMUM	MAXIMUM	DEFAULT	INCREMENTS	MEMORY BLOCK
Hookflash Start Time (HFS)	100 msc.	800 msc.	300 msc.	50 msc.	4B8
Hookflash End Time (HFE)	100 msc.	2200 msc.	1000 msc.	100 msc.	4B8
Bounce Protection Time (BP)	0 msc.	1400 msc.	300 msc.	100 msc.	4B8
Pause Time	0 msc.	7000 msc.	1000 msc.	500 msc.	4B9
Disconnect Time	500 msc.	3300 msc.	1500 msc.	200 msc.	4B9
Interdigit Internal Time	40 msc.	180 msc.	70 msc.	10 msc.	4B9
DTMF Digit Duration	60 msc.	760 msc.	110 msc.	50 msc.	4B9



**CHAPTER 9**  
**REMOTE ADMINISTRATION**  
**ADAPTOR RAA - E**  
**INSTALLATION AND**  
**PROGRAMMING PROCEDURES**



# CHAPTER 9

## REMOTE ADMINISTRATION ADAPTOR

### TABLE OF CONTENTS

SECTION	DESCRIPTION	PAGE
<b>910 EQUIPMENT DESCRIPTION</b>		
910.1	Remote Administration Adaptor Unit (With Host Disk)	900-1
910.2	PC-8300 Personal Computer	900-1
910.3	PC-8231A Micro Floppy Disk Drive	900-2
910.4	PC-8295A-01 RS232C Cable - Normal	900-2
910.5	PC -8295A-02 RS232C Cable - Reversed	900-2
910.6	Modems	900-2
<b>920 RAA-E and MODEM INSTALLATION</b>		
920.1	RAA-E Unit Switch Settings	900-3
920.2	Wall Mounting the RAA-E Unit	900-4
920.3	Connecting the RAA-E to the Electra MarkII	900-4
920.4	Connecting the RAA-E to the Modem	900-5
920.5	Connecting the Modem to a Line	900-5
920.6	Grounding the RAA-E and Modem	900-5
920.7	Modem to Modem Connection	900-5
<b>930 PC-8300 and PC-8231A INSTALLATION</b>		
930.1	PC-8300 Power Supply Options	900-6
930.2	Backup Power	900-7
930.3	Turning the Power On	900-8
930.4	Turning the Power Off	900-8
930.5	Automatic Shut Off	900-8
930.6	Low Battery LED	900-9
930.7	PC-8231A Micro Disk Unit Connection	900-9
930.8	Operating the PC-8231A Micro Disk Unit	900-9
930.9	Initialization Procedure for PC8300	900-10
<b>940 PROGRAMMING</b>		
940.1	General	900-11
940.2	Program Boot Procedure	900-12
940.3	Programming via the PC-8300	900-13
940.4	Programming Example	900-13
940.5	IBM Type Compatible Version Software	900-16
940.6	General Programming Notes	900-18

### SECTION 910 EQUIPMENT DESCRIPTION

#### 910.1 REMOTE ADMINISTRATION ADAPTOR UNIT

The Remote Administration Adaptor unit (RAA-E) is a compact, self-contained unit (7.9 in x 3.9 in x 1.9 in, 200mm x 100mm x 50mm) that allows remote or local programming of the Electra MarkII system by means of a personal computer.

The RAA-E unit contains an RJ11C modular jack for connection to the Electra MarkII system, and an RS-232C connector for connection to a modem or a PC. It also contains 5 switches for proper interface settings; a green LED to indicate power is available; a hybrid IC card for interfacing with the system; an 8-bit processor; a 16KBYTE ROM IC; and associated circuitry.

The RAA-E unit requires no external power source. It is powered by the Electra MarkII system via the modular jack connection.

The function of the RAA-E unit is to translate the Manchester Encoded data (from the ESI-E( ) ETU) to ASCII signals for use by the PC or modems.

A floppy disk is supplied with the RAA-E unit. This disk software is written in one of two formats, either CP/M-DOSN 82 Basic (for use with the NEC PC-8300 or equivalent computer) or MS-DOS Basic (for use with the NEC APC IV or equivalent computer).

The CP/M-DOS is available in one disk size, 3.5 inches. The MS-DOS is available in one of two disk sizes, 5.25 inches or 3.5 inches.

The CP/M-DOS disk contains the Disk Operating System and the RAA Host Program which is listed as file named ADMI.DO.

The MS-DOS disk does not contain a disk operating system; it does contain a Communication Application Program and the RAA Host Program, both listed in a file named COMLINK.

#### 910.2 PC-8300 PERSONAL COMPUTER

The PC-8300 is an NEC portable laptop personal computer containing 128K ROM and 64K RAM. It uses an 8085 microprocessor and CMOS components for low power consumption. It comes equipped with an RS-232C serial I/O port and a Centronics parallel

printer port. When connected to the RAA-E via modems, the PC-8300 can be used to program the system from a remote location. ( See Figure 910-1.)

A PC-8201A (expanded to 64K RAM), IBM XT, IBM AT, NEC APCIV, or NEC Multispeed, may be used instead of the PC-8300.

### 910.3 PC-8231A MICRO FLOPPY DISK DRIVE

The PC-8231A is an NEC micro floppy disk drive unit designed to work with NEC's PC-8300 and PC-8201A computers. This disk drive unit uses a single, 3.5 inch single-sided, double density, 320K diskette. It is not required when using the IBM compatible computers.

### 910.4 PC-8295A-01 RS-232C CABLE - NORMAL

The NEC PC-8295A-01 cables are standard RS-232C jack-to-jack (male to male) cables used to connect the computer and RAA-E units to modems. This cable uses pins 1 thru 8, 20, and 22.

### 910.5 PC-8295A-02 RS-232C CABLE REVERSED

The PC-8295A-02 cable is an RS-232C jack-to-jack (male to male) cable which has several wiring reversals as compared to a standard RS-232C cable. This cable is sometimes called a **null modem** cable. The following leads which are used with the RAA-E are reversed within the cable: 2 and 3; 4 and 5; and 6 and 20. Pins 1 and 7 are **not** reversed. This cable is used when the RAA-E unit is connected directly to the computer (**without a modem**). This arrangement can be used to test the RAA-E unit with the computer or to familiarize oneself with the operation of the computer in conjunction with the RAA-E.

### 910.6 MODEMS

Two modems are required for programming via the Remote Administration Adaptor. The first modem is connected to the RAA-E unit located at the job site where the system being programmed is located. The second modem is connected to the computer located at the distant location, from which the actual data entry is being made. (See Figure 910-1).

The modems must be locally provided. They must be asynchronous type modems capable of transmitting/receiving data at 300, 600, 1200 or 2400 baud. Both modems and the RAA must be set at the same baud rate.

The RAA-E uses 8 bit ASCII Protocol with 2 start/stop bits and no parity.

Refer to the modem's instruction manual to set up the different parameters. Some modems use dip switches for set up, and some types need a PC with a terminal emulation program to set these parameters.

**NOTE:** Problems may occur at baud rates higher than 1200 on standard voice grade telephone lines. If a transmission rate of 2400 baud is required, it may be necessary to use data grade lines to ensure the integrity of the data being transmitted between modems.

Figure 910-1 provides an overview of the relationship of equipment used with an RAA-E unit. Once a connection is established, the signal flow at the remote location is from the computer, to the modem and out through the CO. At the Electra MarkII

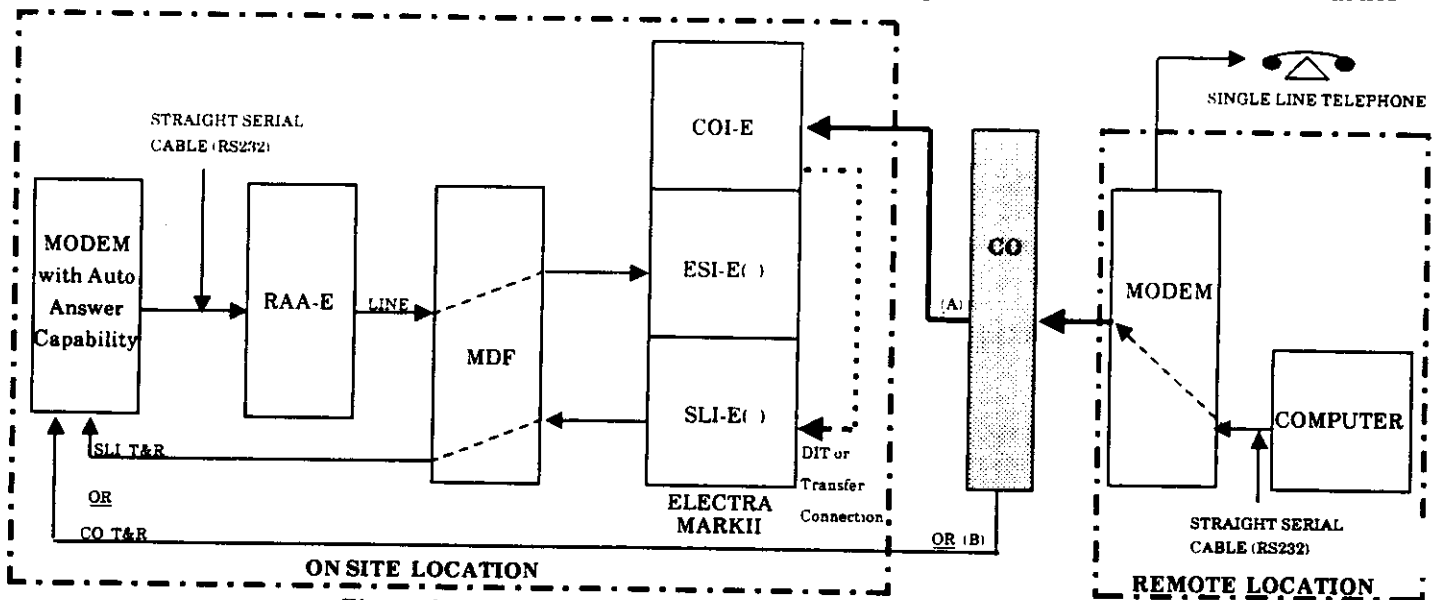

Figure 910-1 RAA-E Block Diagram Hook Up & Signal Flow

location, the signal comes in from the CO in one of two ways (A): through the COI-E ETU from there it is transferred or diverted via DIT/ANA into the SLI-E( ) ETU. From the SLI-E( ) ETU the signal goes through the modem to the RAA-E unit and to the ESI-E( ) ETU programming port of the Electra MarkII system. Signal flow from the on site location (to a remote location) is in the opposite direction. OR (B): the CO may be connected directly to the modem if so desired.

## SECTION 920

### RAA-E and MODEM INSTALLATION 920.1 RAA-E UNIT SWITCH SETTINGS

The RAA-E unit has five switches which are used to set up proper interfacing to the modem or computer, and between the RAA-E unit and the Electra MarkII system. Switch SW1 is located on the front of the RAA-E unit. Switches SW2~SW5 are accessed by removing the grounding screw located on the rear of the RAA-E unit and pulling back and up on the RAA-E cover (See Figure 920-1). Reassembly is accomplished by reversing this procedure. Switches perform the following functions:

**NOTE:** If the switch settings are changed for any reason, disconnect and reconnect the modular line cord. This allows the RAA-E to read the new settings. (Table 920-1 shows the switch settings.)

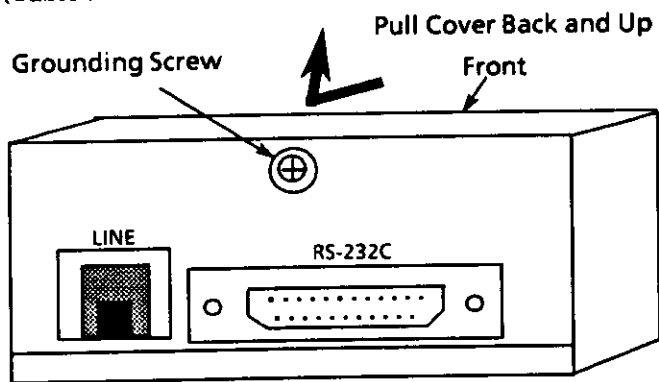

Figure 920-1 Removal of RAA-E Cover (Rear View of RAA-E Unit)

1. SW1 - Baud Rate Switch is a bank switch consisting of 4 dip switches accessible from the front panel next to the POWER LED indicator. This switch must be set to the same baud rate as the modem connected to the RAA-E unit. Only one dip switch should be set to the ON position, the other three must be off. A baud rate setting of 300, 600, 1200, or 2400 can be obtained by turning on the corresponding dip switch.

2. SW2 - Direct/Modem Switch is used to tell the processor in the RAA-E unit that it is connected directly to the computer (DIRECT position) or to a modem (MODEM position).

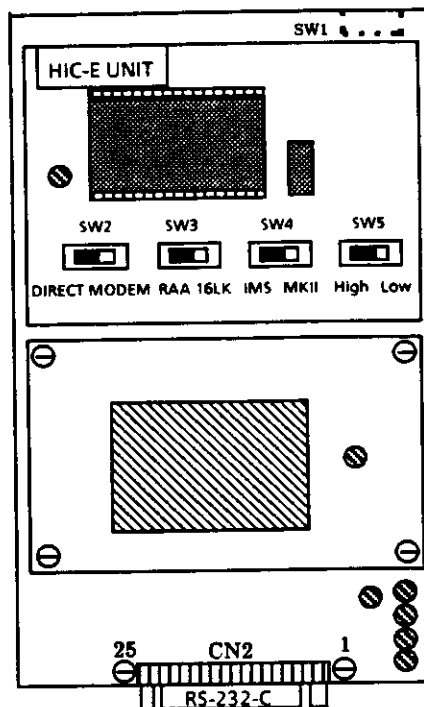

Figure 920-2 RAA-E Unit Switch Locations (Top View)

3. SW3 - RAA/16LK Switch tells the RAA-E unit how to configure itself to translate the information being received from the system and being sent to the system. This switch should be set to the RAA position. The 16LK position is reserved for future use.

Table 920-1 RAA-E Switch Setting

SWITCH NUMBER	SWITCH NAME	FIGURE	DEFAULT VALUE
1	Baud Rate		300 Baud
2	Modem		Direct
3	Type Request		16LK
4	System Select		MK II
5	Reserved for Future Use		Low

4. SW4 - IMS/MKII Switch tells the RAA-E unit the type of system to which it is connected: Electra IMS or Electra MarkII. Set the switch to the MKII position.
5. SW5 - High/Low Switch is reserved for future use and has no function.

**920.2 WALL MOUNTING the RAA-E UNIT**

When wall mounting the RAA-E unit, the site selected should meet the following conditions:

1. High enough off the floor to prevent damage due to flooding.
2. Away from water pipes to prevent damage due to leaks or condensation.
3. An area free of corrosive or flammable gases, excessive chemical or industrial dust, and other materials which could be a hazard to personnel or equipment.
4. Away from strong electric and/or magnetic fields, heavy motors, radio transmission, etc.
5. An ambient temperature of +50°F to +90°F (10°C to 32°C) and 10% to 90% relative, non-condensing humidity.
6. Mounted on the systems MDF, or an adjacent backboard.

A wall mounting bracket is supplied with the RAA-E unit. The following steps outline the procedure for wall mounting the RAA-E unit.

**NOTE:** When locating the RAA-E unit on the wall, allow space for the connection of the RS-232C cable to avoid sharp bends on the cable. The RS-232C cable should not exceed 50ft. in length.

1. Attach the wall mounting bracket to the RAA-E unit with the screws provided, as shown in Figure 920-3.
2. Locate the RAA-E unit with mounting bracket on the wall in the desired position.
3. Using the wall mounting bracket, already attached to the RAA-E unit, as a template, mark the location of the wall mounting screws (A and B).
4. Using Number 8 panhead woodscrews, insert the screws into the positions marked. Do not tighten the screws all the way, leave enough room for the bracket to be placed over the screw head.
5. Place the RAA-E unit with mounting bracket attached onto the mounting screws and secure it to the wall by tightening the screws (A and B).

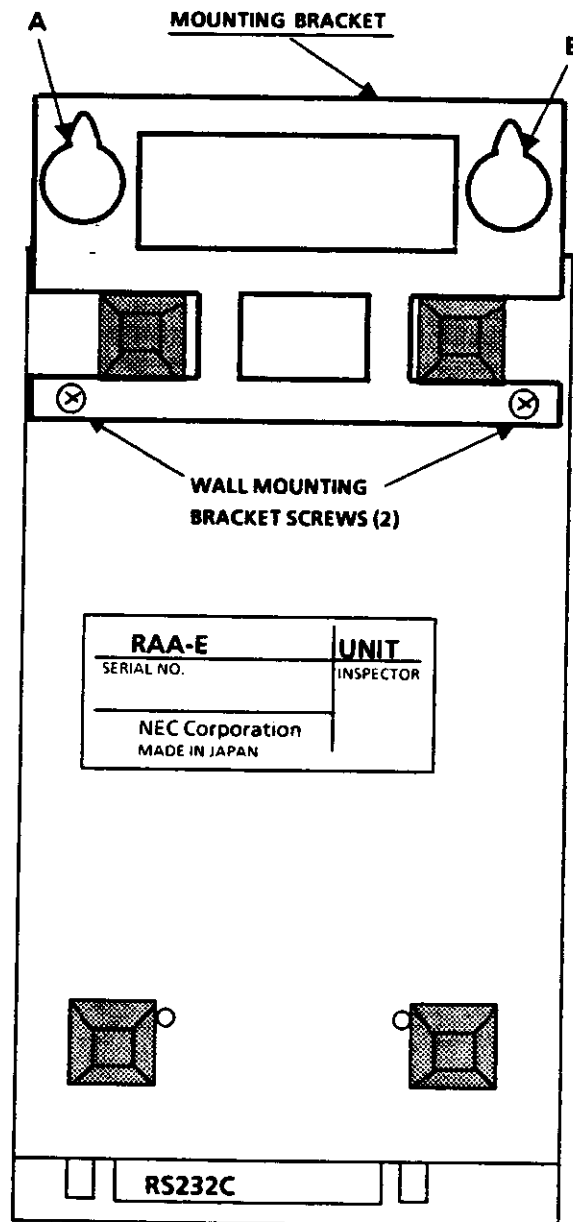

Figure 920-3 RAA-E Bottom View with Wall Mounting Bracket Attached

**920.3 CONNECTING the RAA-E to the ELECTRA MARKII**

1. The RAA-E unit is connected to the system via a standard modular line cord (not provided). Connect one end of the modular line cord to the modular jack (RJ11C) located at the rear of the RAA-E unit (labeled line).
2. Connect the other end of the modular line cord to a modular jack (RJ11C) connected to an ESI-E( station port of the system at the MDF J-blocks.



**NOTES:** 1. The Electra MarkII system may have up to four programming station ports. The first two are permanently assigned to the first two ports of the first ESI-E( ) ETU. The third position can be assigned by either of the first two programming stations to be any ESI-E( ) ETU port supporting an ETE-16D-1. When connected, the fourth programming assignment is for the RAA-E unit. (See Chapter 3, Programming, Memory Block 1E2). The RAA-E maintains its programming port status, even after an extended power loss or after a 1st initialization occurs.

2. Ensure that all the RAA-E switch settings are correct before plugging in the RAA-E modular jack.

3. If the RAA is connected to an attendant port the RAA-E will gain attendant programming features.

#### 920.4 CONNECTING the RAA-E to a MODEM

Refer to Table 920-2 for the pin functions of the PC-8295A-01 cable.

Table 920-2 PC-8295A-01 Cable-Normal

Pin #	Function
1	Frame Ground (FG)
2	Transmit Data (TXD)
3	Receive Data (RXT)
4	Request to Send (RTS)
5	Clear to Send (CTS)
6	Data Set Ready (DSR)
7	Signal Ground (SG)
8	Carrier Detect (CD)
20	Data Terminal Ready (DTR)
22	Ring Indicator (Detect) (RI)

1. Connect one end of the PC-8295A-01 to the RS-232C connector located on the rear of the RAA-E.

2. Connect the other end of the PC-8295A-01 to the RS-232C connector of the modem.

Refer to Table 920-3 for the pin assignments of the RAA-E RS-232C connector.

Table 920-3 RAA-E/Modem Signal Flow

Pin #	Function	Signal Flow	
		RAA-E	Modem
1	Frame Ground	↔	
2	Transmit Data	→	
3	Receive Data	←	
4	RTS	→	
5	CTS	←	
6	DSR	←	
7	Signal Ground	↔	
8	CD	←	
20	DTR	→	
22	RI (not connected)		

#### 920.5 CONNECTING the MODEM to a LINE

Although it is possible to dedicate a CO line to the on-site modem for remote administration purposes, it is recommended that this modem be connected to a single line port of the system instead. This way, when calling in to use the Remote Administration Adaptor, the system attendant can transfer the calling party (programmer) to the station number associated with the SLI port connected to the modem.

If so desired, a trunk may be programmed to terminate directly to the single line port, thus eliminating the need for attendant intervention with a system supported by a CPU-EB2 (or higher) ETU.

**NOTE:** In this application, the modem connected to the RAA-E must have auto answer capability.

The following steps should be considered when connecting the modem to a line.

1. Ensure that all switches are properly set in the modem. Take special care that the baud rate setting of the modem matches that of the RAA-E, and that the modem is set for auto answer.

2. If a dedicated Central Office (CO) line is being used, connect the CO line to the modem as described in the instruction manual provided by the modem manufacturer. If a single line port position is used, connect the modem to the single line port as if it were an SLT, following the instructions provided by the modem manufacturer. If a line is not already available, it may be necessary to run a cable and connect a modular jack to a single line port of the system's MDF.

#### 920.6 GROUNDING the RAA-E and MODEM

The RAA-E unit and the modem connected to it, must be grounded to the same earth ground point. In order to effectively ground the RAA-E unit, a spade lug connected to an 18 AWG grounded wire should be fastened underneath the screw on the back (RS-232C side) of the RAA-E unit. (See Figure 920-1.)

#### 920.7 MODEM to MODEM CONNECTION

Depending upon the type of modems and computers used, the procedures used to make the end to end modem connections will vary. Refer to the modem's and computer's instruction manual to determine the proper procedure for end to end connection. Things to take into account are manual or autodial capabilities and manual or auto answer capabilities. It should also be noted that the ADMI.DO File is a stand alone Host program and does not contain a Communications Application program, therefore, Request To Send (RTS) and Data Terminal Ready (DTR) will not be ON

at the PC Communications Port (COM PORT) when the file is executed.

### SECTION 930

#### PC8300 and PC-8231A INSTALLATION

This section is written to provide a complete and comprehensive understanding of how to properly connect the PC-8300 portable computer and PC-8231A disk drive.

##### 930.1 PC-8300 POWER SUPPLY OPTIONS

The PC-8300 has three main power source options:

- AA batteries,
- an optional AC adaptor,
- a rechargeable NiCad battery cartridge.

This section describes how to install each of these three power sources.

- **AA BATTERIES** - The PC-8300 can operate on four standard or alkaline AA batteries installed in the standard battery pack.

NiCad batteries cannot be used in the standard battery pack, the optional NiCad battery cartridge is necessary if rechargeable batteries are required.

Different types of batteries may be used in the main battery case. The life span of different batteries will vary according to temperature and other conditions.

- Alkaline Batteries: approximately 18 hours
- Standard Batteries: approximately 6 hours

To install AA batteries, follow these steps.

1. Turn the power switch to the OFF position, refer to Figure 930-1.

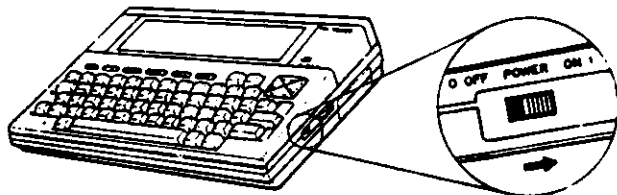

Figure 930-1 Power Switch Location

2. Place the PC-8300 face down on a level surface, ensuring there is no pressure on the LCD.
3. Place one of your thumbs at point A and the other thumb on point B as indicated in Figure 930-2.

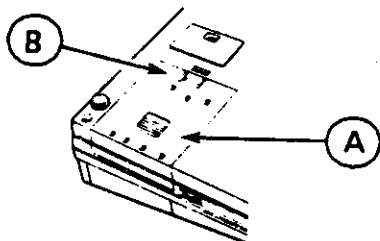

Figure 930-2 Battery Pack Location

4. Push down and outward with both thumbs remove the battery compartment, see Figure 930-3.

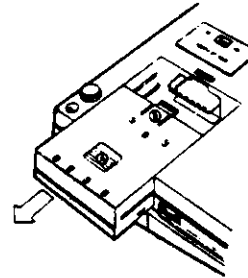

Figure 930-3 Removal of Battery Pack

5. Remove the battery case completely and turn it over so the tab is on the bottom, refer to Figure 930-4.

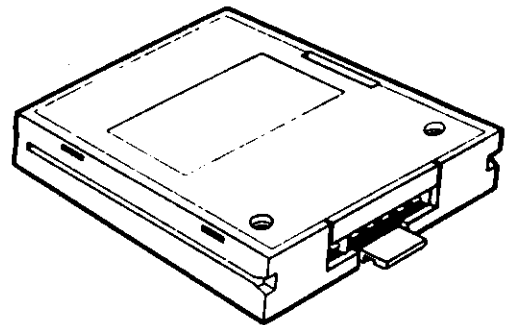

Figure 930-4 Battery Pack

6. Insert a quarter into the slot, as shown in Figure 930-5, and gently pry off the top of the battery case.

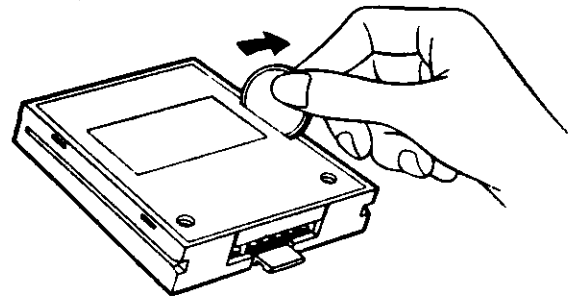

Figure 930-5 Removal of Battery Pack Cover

7. Insert the four AA size batteries with positive and negative poles positioned as shown in Figure 930-6. All negative poles must be touching the springs of the battery case. If the batteries are not placed exactly as described, the PC-8300 could be damaged.

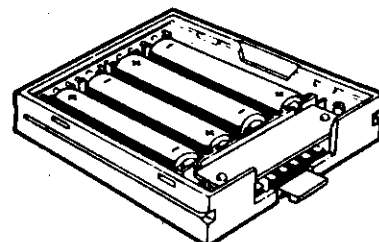

Figure 930-6 Inserting Batteries

8. Snap the top of the battery case in place. Install the battery case as shown in Figure 930-7.

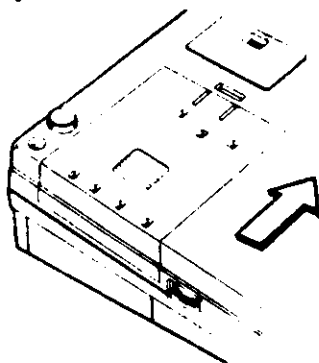

Figure 930-7 Replacing Battery Pack

- **AC ADAPTOR** - If using a PC-8300 near a wall outlet, the optional AC adaptor (PC-8271A-01), is another convenient power source.

To connect the AC adaptor to the PC-8300, follow these steps (See Figure 930-8).

1. Plug the AC adaptor into the wall outlet.
2. With the PC-8300 power switch turned off, plug the single jack end of the PC-8271A-01 into the interface on the rear of the PC-8300, labeled DC 8.5V.

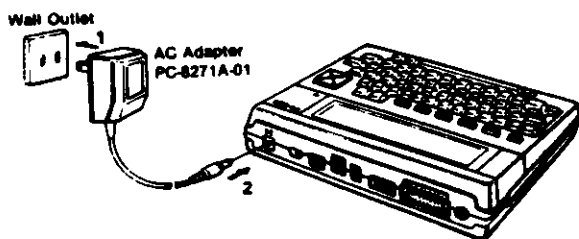

Figure 930-8 AC Adaptor Connection

**NOTES:** 1. When connecting the AC adaptor, make sure that the power switch of the PC-8300 is off. (See Figure 930-1).

2. When connecting the AC adaptor to the PC-8300, ALWAYS plug the adaptor into the wall outlet before connecting it to the unit.
3. The adaptor should first be unplugged from the PC-8300 before disconnecting.
4. Be certain that you use the PC-8271A-01 AC adaptor ONLY. Serious damage to the PC-8300 personal computer may be caused by using any other adaptor.
5. If you connect the AC adaptor to the PC-8300, when batteries are inserted in the battery case, the

PC-8300 will operate from the AC adaptor not from the batteries.

- **NiCad (Nickel-Cadmium) Battery Cartridge** - The optional NiCad battery cartridge (PC-8301A-90 or PC-8201A-90) can be used in place of the regular battery pack containing standard or alkaline AA batteries. The main advantage of using the NiCad battery cartridge is that it may be recharged more than 500 times by using the AC adaptor (PC-8271A-01).

The insertion and removal of the NiCad battery cartridge in the PC-8300 is performed the same as for a regular battery pack, as described in the section on AA battery installation; however the cartridge may not be opened. This battery cartridge is recharged continuously when the AC adaptor is connected to the PC-8300, even when the power switch is turned off.

The AC adaptor supplies electrical power to the PC-8300 via a wall outlet while the NiCad battery cartridge is recharging. The recharging process is completed in approximately 48 hours. The NiCad battery cartridge should have a full charge prior to using it for the first time.

The NiCad battery cartridge should be recharged as soon as possible after the low battery LED on the front of the PC-8300 illuminates. Keep in mind that the NiCad battery cartridge may not reach its full potential until the unit has been used and recharged 2 or 3 times. Once the NiCad battery cartridge can no longer hold a charge, the entire cartridge must be replaced.

Careful handling of this cartridge is necessary for optimum performance. The terminal connector portion of the cartridge should never be touched, and the cartridge should never be dropped. The cartridge should be stored in an area with low humidity. The NiCad Battery Cartridge Life Span (with battery fully charged) is over 5.5 hours.

**NOTE:** The use of any AC adaptor other than the PC-8271A-01 can cause serious damage to the NiCad battery cartridge.

### 930.2 BACKUP POWER

The Backup Power switch is located on the bottom of the PC-8300 (See Figure 930-9). It must be turned on before you switch on the main power supply of the PC-8300 for the first time.

The switch is for the backup system that is powered by an internal NiCad battery in the PC-8300. Even when the main power supply of the PC-8300 is turned off, the internal NiCad battery maintains a backup

power supply to the PC-8300 RAM so that your files stored in the PC-8300 are saved. It operates only when the power switch of the PC-8300 is turned off.

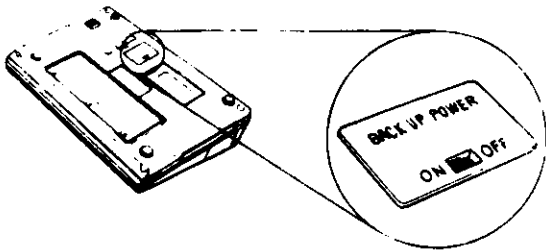

Figure 930-9 Backup Power Switch

The Backup Power switch should be turned off only if you will not be using the PC-8300 for an extended period (longer than one month) in order to avoid the total discharge of the batteries and deterioration in performance.

The Backup Battery will save the files and store them internally for 7 days without any batteries in the battery pack and without an AC adaptor connected to the PC-8300.

When the Backup Power switch is turned off, all files stored in the PC-8300 will be lost. Make sure that important files are saved onto an external storage device before you turn the Backup Power switch off.

Due to their rechargeable nature, the NiCad backup battery has a total life span of approximately 2-1/2 years. After that time, you will probably need to take the PC-8300 to your NEC distributor for replacement, since the internal cell will start to lose its ability to hold a charge.

### 930.3 TURNING THE POWER ON

To turn on the power of the PC-8300 for the first time, or after an extended period of storage, use the following procedure:

1. Make sure the batteries are inserted properly or that the PC-8271A-01 AC adaptor is properly connected as outlined in section 930.1.
2. Turn on the Backup Power switch on the bottom of the PC-8300.
3. Turn on the power switch on the right side of the PC-8300.
4. While holding CTRL and SHIFT down, press the RESET button on the rear of the PC-8300. Then release both CTRL and SHIFT. This procedure is called a cold start.
5. Adjust the contrast control (See Figure 930-10) on the right side of the PC-8300 so that the LCD display

gives the right amount of contrast and light for comfortable viewing.

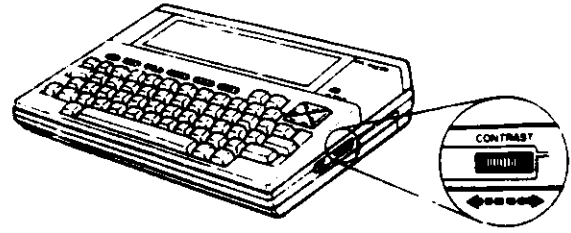

Figure 930-10 Contrast Adjustment

Once the power has been turned on and the screen contrast has been adjusted, the display should always appear as shown below after a cold start.

```

1983/01/01  00:00:00  (C)Microsoft #1

BASIC      TEXT      TELCOM     ..
..         ..         ..         ..
..         ..         ..         ..
..         ..         ..         ..
..         ..         ..         ..
..         ..         ..         ..
Load  Save  Name      List  25717*

*28758 When using PC-8201A
  
```

Although you may eventually have more files than shown above, you should at least have the BASIC, TEXT, and TELCOM file names displayed on the screen, since these three are written in the Read Only Memory or ROM. They will not be erased, even by a cold start.

If the screen does not look like the one shown, you should perform a cold start again. (Refer to paragraph 930.3 step 4).

To turn the power on for the second and subsequent times, only turn on the power switch on the right side of the PC-8300.

### 930.4 TURNING the POWER OFF

The power supply to the PC-8300 can be turned off at almost any time, whether you're in an application software program or whether you're in the MENU. The Backup Battery maintains the contents of the memory when the power is turned off.

### 930.5 AUTOMATIC SHUT-OFF

When the PC-8300 is on and no key has been depressed for over 10 minutes, the unit's power will automatically shut-off to prevent excess discharge of the batteries. When the automatic shut-off function has been activated, the power switch has to be

manually set to the **OFF** position and then turned **ON** again, to turn the PC-8300 back on.

The predetermined time period of 10 minutes after a cold start for the automatic shut-off can be altered using a BASIC language **POWER** command. The automatic shut-off feature may be canceled by the use of the **POWER CONT** command when the AC adaptor is connected to the PC-8300. (Refer to the PC-8300 User's Guide)

The only times the automatic shut-off function cannot be activated is when the PC-8300 is in the terminal mode of **TELCOM**, and when a BASIC program is being run.

### 930.6 LOW BATTERY LED

If the batteries have a low charge, causing the Backup Battery to be used, the Low Battery LED on the PC-8300 will illuminate. The batteries must be charged as you can only operate the PC-8300 for approximately 20 minutes with the Backup Battery.

Storing the PC-8300 for a long time with a low battery charge will cause it to become inoperable.

If you continue to operate the PC-8300 with the Low Battery LED lit for more than 20 minutes, the unit will become inoperable and you will lose all data stored in the RAM. Batteries should be replaced as soon as possible after the Low Battery LED illuminates. The power switch must always be turned **OFF** while changing batteries.

### 930.7 PC-8231A MICRO DISK UNIT CONNECTION

Make sure that the power supplies of both units are **OFF** when connecting the units together.

#### 930.7.1 Connection of the PC-8231A's Signal Connector

The standard 8 pin signal connector is on the left side of the PC-8231A unit. If a toroid (ferrite ring) is provided, connect the end with the toroid to the Micro Disk Unit. (See Figure 930-11).

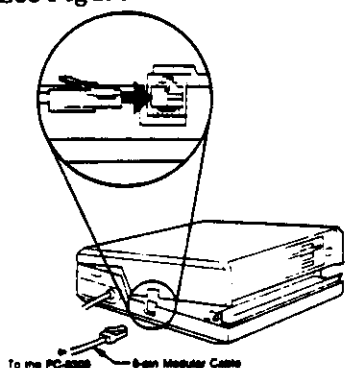

Figure 930-11 8 Pin Connector (PC-8231A)

#### 930.7.2 Connection to the PC-8300

After connecting one end of the 8 pin modular cable to the PC-8231A unit, connect the other end to the connection marked **FDD (SIO1)** when using PC-8201A), on the back panel of the PC-8300. (See Figure 930-12).

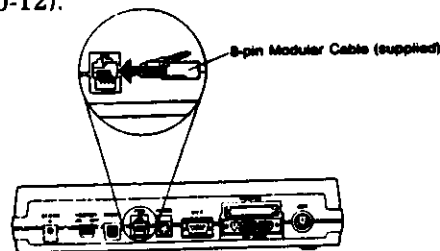

Figure 930-12 8 Pin Connector (PC-8300)

#### 930.7.3 Inserting the AC Power Pack

Power to the Micro Disk Unit can be supplied from the AC pack (included). The AC power is installed by inserting the AC pack as shown in Figure 930-13. Be sure to insert the AC pack into the device until it clicks in place, thus making sure that it will not pop out during use. The inlet is usually covered by a sliding cover.

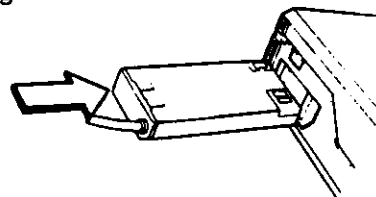

Figure 930-13 AC Power Pack (PC-8231A)

### 930.8 OPERATING the PC-8231A MICRO DISK UNIT

#### 930.8.1 Opening the PC-8231A

The lid of the PC-8231A is opened by the slide-lock buttons on the left and right sides of the unit. Place your hands on both of these buttons and lift the top half of the unit up while pulling these slide-lock buttons. Raise the front side of the unit approximately 2 inches (5cm) and the lid will automatically open and the front side of the unit will slowly come down. The lid will support itself in the open position as shown in Figure 930-14.

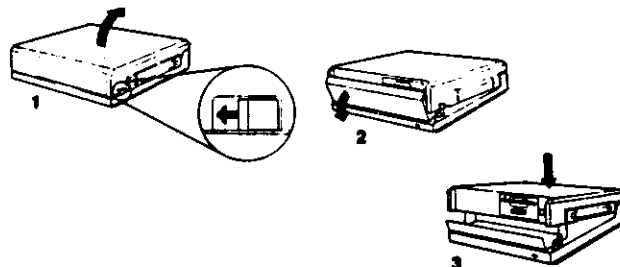

Figure 930-14 Opening the Disk Drive

### 930.8.2 Inserting a Micro Floppy Disk

To insert a micro floppy disk into the PC-8231A, first make sure the power to the PC-8231A is turned OFF. Position the micro floppy disk with the spindle side down and insert into the drive until about 1/2 inch of it can be seen as shown in Figure 930-15.

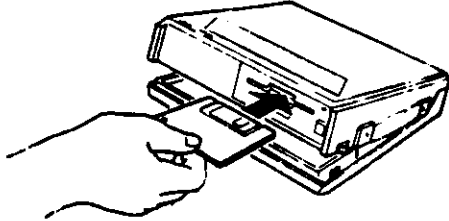

Figure 930-15 Inserting a Floppy Disk

Then, gently push the micro floppy disk into the drive until it clicks into place, the eject button is popped out, and the drive is closed.

Figure 930-16 shows the micro floppy disk inserted in correct and incorrect positions.

**NOTE:** Bending or forcing the micro floppy disk into the drive may damage it.

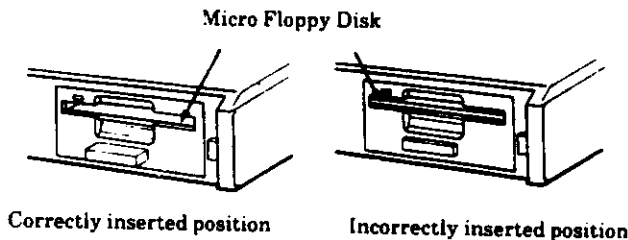

Figure 930-16 Views of Inserted Disks

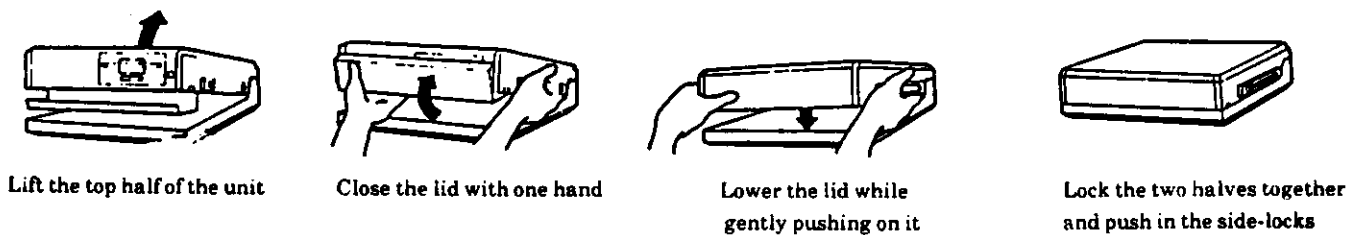

Figure 930-17 Closing the Disk Drive

### 930.8.3 Removing a Micro Floppy Disk

To remove a micro floppy disk from the drive, push the eject button on the PC-8231A in until the micro floppy disk pops out of the drive. Then simply remove the disk.

**NOTE:** Never remove the micro floppy disk from the drive when the access indicator LED is on or before an open file is closed. You may cause a read error and the data may be permanently damaged.

### 930.8.4 Closing the PC-8231A

To close the PC-8231A, remove the micro floppy disk from the drive. Turn the power to the PC-8231A off.

- Lift the top half of the unit
- Close the lid with one hand
- Lower the lid while gently pushing on it
- Lock the two halves together and push in the slide-locks. (See Figure 930-17).

**CAUTION:** Make sure the PC-8231A is closed and secure before moving or transporting the unit.

## 930.9 INITIALIZATION PROCEDURE for PC-8300

### 930.9.1 General Information

It is important that you clearly understand the two ways to boot your PC-8300. The two procedures are very different, they are used in different situations, and produce very different results. These two booting methods are called **warm start** and **cold start** respectively.

The usual method of turning on the power is called a **warm start** by which the PC-8300 is turned on without initializing (clearing) the file storage area, the data in its RAM, or the setting of the real-time clock. Any files previously created and stored in the RAM are still saved there.

A cold start initializes (clears) the RAM areas, so any files you may have had there will be erased. A cold start is used to start the PC-8300 for the first time, after a long period of non-use, and also to reset if locked up.

When turning on the Backup Power switch, it is necessary to initialize all of the RAM by performing a cold start. Also, when you want to clear the RAM of all the files, perform a cold start.

### 930.9.2 Initializing the PC-8300 with a Cold Start

1. Insert the 3.5 inch floppy disk with the **ADMI.DO** software stored. Refer to Section 930.8.2 of this manual. Turn on the power switch of the Micro Disk Unit.
2. Turn on the Backup Power switch of the PC-8300.
3. Turn the PC-8300 power switch to the ON position.
4. If in the MENU mode, hold CTRL and SHIFT keys down.
5. Press and release the RESET switch on the back of the PC-8300.
6. Release CTRL and SHIFT keys.

The screen is erased for an instant after a cold start, and then the MENU appears on the screen. Since the RAM has been completely erased and initialized, the MENU displays no file names other than the three primary files BASIC, TEXT, and TELCOM, since they are in ROM.

1983/01/01 00:00:00 (C)Microsoft #1				
BASIC	TEXT	TELCOM	--	
--	--	--	--	
--	--	--	--	
--	--	--	--	
--	--	--	--	
--	--	--	--	
Load	Save	Name	List	25717

**NOTES:** 1. If the PC-8300 MENU screen does not appear, repeat the cold start setting procedure.

2. Before performing a cold start, be sure that important files have been saved on some external storage medium, such as a cassette tape or a floppy disk; otherwise all those files will be lost.

## SECTION 940 PROGRAMMING

### 940.1 GENERAL

**NOTE:** Before programming with the RAA-E unit, its connecting port must be programmed as an RAA-E port in Memory Block 1E2 (LK9). Programming Memory Block 1E2 is not required if the RAA-E unit is connected to the Electra MarkII system prior to performing a first initialization. Make sure that the RAA-E switch settings are set properly. (See Table 920-1).

The programmer must be completely familiar with the programming procedures of the Electra MarkII system before programming using the Remote Administration Adaptor (RAA-E). Programming procedures for the Electra MarkII system using the RAA-E are outlined in the following paragraphs.

The Remote Administration Adaptor (RAA-E) allows a PC to be used as a programming terminal. To program the Electra MarkII system, Function and Line Keys are used when inputting information from a programming station. To input information from a PC enter the actual characters shown on the keyboard. For example: to enter data for Function Button F1, depress characters F and then 1 on the keyboard of the PC, then depress ← (**Return Key**) to enter the information. To enter data for Line Button L1, depress characters L and 1 on the keyboard, then depress ← (Return) to enter the information.

Table 940-1 lists all the programming keys and the corresponding PC keyboard entries.

To enter data for Function and Line Keys, the CAPS key on the PC keyboard must be depressed and locked. If the CAPS key is not locked on, the characters representing letters will not be recognized or displayed on the screen.

If Function/Line Key numbers that are within the valid range (F1~F20 and L1~L16) are entered but are not in a recognized sequence in the Electra MarkII program, an ALARM 1 signal is displayed on the PC screen accompanied by four tones. For example: F3, F8, and F18 entered.

ALARM 1 is displayed because F18 is not in the sequence recognizable by the Electra MarkII program, even though it is within the range of valid Function Key numbers.

ALARM 2 is displayed when data input is temporarily prohibited from being entered for one of the following reasons:

1. An attempt has been made to eliminate a line key appearance while the line key is in a ringing, I-use or I-hold mode.
  2. A busy-out of a station is attempted while the station is in use.
  3. While a station is communicating data, a data change is attempted to the station.
- ALARM 3** is displayed when an illegal entry is attempted for System Speed Dial entry or clock/calendar setting. Example: Trying to enter System Speed Dial buffer 100 or time of day as 25 hours.

An **INPUT NUMBER ERROR** display is received when an invalid Function Key number or Line Key number which is outside the range of valid Function/Line Key numbers (F21 and above and L17 and above) is entered. For Example: F1, F9, and F21. In this case F21 is an invalid key number outside the range of Function Key numbers.

**940.2 PROGRAM BOOT PROCEDURES**  
**940.2.1 INITIAL PROGRAM BOOT**  
**PROCEDURE (SET-UP)**

After a Cold Start power up of the PC-8300 as described in paragraph 930.3, the initial display is as shown below with the word **BASIC** highlighted in dark shading.

```

1983/01/01 00:00:00 (C)Microsoft #1
BASIC TEXT TELCOM --
-- -- -- --
-- -- -- --
-- -- -- --
-- -- -- --
-- -- -- --
Load Save Name List 28758
  
```

Depress special function button f\*1 (load) on the PC. (Located directly below the display screen's left side).  
 Display changes to:

```

1983/01/01 00:00:00 (C)Microsoft #1
BASIC TEXT TELCOM --
-- -- -- --
-- -- -- --
-- -- -- --
-- -- -- --
-- -- -- --
Load from
  
```

Type: 1: **ADMI.DO** (Ensure Caps Lock is on).  
 Depress: ← (Return)

Display changes to:

```

1983/01/01 00:00:02 (C)Microsoft #1
BASIC TEXT TELCOM --
-- -- -- --
-- -- -- --
-- -- -- --
-- -- -- --
-- -- -- --
Save as
  
```

Type: **ADMI.BA**  
 Depress: ← (Return).  
 Display prompts: **Ready?**  
 Depress: ← (Return)

Red LED on disk drive flashes on, then off.  
 Display changes to:

```

1983/01/01 00:00:04 (C)Microsoft #1
BASIC TEXT TELCOM ADMI.BA
-- -- -- --
-- -- -- --
-- -- -- --
-- -- -- --
-- -- -- --
Load Save Name List 21193
  
```

**940.2.2 RAA PROGRAM BOOT (PC-8300)**

Using the cursor movement keys, move the cursor to the upper right hand corner of the display over the word **ADMI.BA**

Depress: ← (RETURN)  
 Display prompts:  
 \*\*\* MAINTENANCE TERMINAL \*\*\*  
 HIT ANY KEY TO LOGIN

Depress any key. (A tone is provided.)

Display prompts:

PLEASE SELECT YOUR SYSTEM  
 A: ELECTRA-IMS  
 B: ELECTRA-MARK2

Depress B to select the Electra MarkII system. (A tone is provided.)

Display prompts:

PLEASE INPUT KEY DATA FOR bps  
 A: 2400 bps B: 1200 bps  
 C: 600 bps D: 300 bps

**NOTE:** Baud Rate selected must be the same as the setting of Baud Rate Switch on RAA-E unit and at which modems are working (when provided).



Depress appropriate key for Baud Rate. (A tone is provided.)

The following display appears on the screen:

```

12:01 JAN 01 FRI
                <ON HOOK>
LK  1      5      9      13
  ---      ---      ---      ---
  
```

**NOTE:** The Clock/Calendar is the indication that the PC to Electra MarkII system communications link has actually been established. Clock/Calendar may take up to one minute to appear on the display. Line status (dashed lines) will appear upon any change to line status. If you are manually dialing the on site modem using a SLT, Clock/Calendar and line status (dash lines) will appear when the modem to modem connection is made (Section 940.2.1).

Anytime you depress ? on the PC, whether in idle or program mode, a SELF CHECK OK !!! display is received. This verifies that the modem and/or PC 8300 and the RAA-E are communicating.

After SELF CHECK is performed, depress ← (Return) before continuing with the next function. Once you are in a memory block, and a self check is performed, an ALARM 1 is received if another function is attempted before ← (Return) is depressed.

### 940.3 PROGRAMMING VIA the PC

Besides the LCD display of the programming Multiline Terminal, the PC also provides line button indications similar to that of the Multiline Terminal. The display shows the letters LK (signifying Line Key) followed by four line key numbers (1, 5, 9, and 13) equally spaced.

Idle line keys are represented as dashes in groups of four under the corresponding line key numbers.

Once the modem to modem (or direct) connection is established and the RAA program is in use but not in program mode, the PC will display the line status of each line key.

The following display indications are provided on the PC when used for remote administration:

- - Line key in use - green - steady
- X - Line key flashing
- \* - Line key in use - red- steady
- - Line key is idle

1. To go off-hook using the PC, depress @ and receive the following display:

```

EXT LINE
00:00 JAN 00 FRI
                <OFF HOOK>
LK  1      5      9      13
  ---      ---      ---      ---
  @
  
```

2. To go into program mode, type #\*0 ← (Return) and receive the following display:

```

OFF-LINE (X.XX)
PROGRAM MODE
                <OFF HOOK>
LK  1      5      9      13
  ---      ---      ---      ---
# * 0
  
```

### 940.4 PROGRAMMING EXAMPLE

In this example, extension 100 and different line key appearances will be programmed on station 102 as follows:

- LK1 - EXT 100,
- LK2 - Save and Repeat 01,
- LK3 - DND position.

Go into program mode as described above.

Display shows:

```

OFF-LINE (X.XX)
PROGRAM MODE
                <OFF HOOK>
LK  1      5      9      13
  ---      ---      ---      ---
# * 0
  
```

Type: F1 ← (Return) (To enter Terminal Mode).

Display shows:

```

TERMINAL
                <OFF HOOK>
LK  1      5      9      13
  ---      ---      ---      ---
F 1
  
```

TABLE 940-1  
CORRESPONDING PC-8300 KEYBOARD ENTRIES FOR PROGRAMMING FUNCTION KEYS ON  
ELECTRA MARK II SYSTEM

PC-8300 KEYBOARD ENTRIES	PROGRAMMING TERMINAL FUNCTION KEYS	PC-8300 KEYBOARD ENTRIES	PROGRAMMING TERMINAL FUNCTION KEYS
L 1	L1	F 1	F1
L 2	L2	F 2	F2
L 3	L3	F 3	F3
L 4	L4	F 4	F4
L 5	L5	F 5	F5
L 6	L6	F 6	F6
L 7	L7	F 7	F7
L 8	L8	F 8	F8
L 9	L9	F 9	F9
L 1 0	L10	F 1 0	F10
L 1 1	L11	F 1 1	F11
L 1 2	L12	F 1 2	F12
L 1 3	L13	F 1 3	F13
L 1 4	L14	F 1 4	F14
L 1 5	L15	F 1 5	F15
L 1 6	L16	F 1 6	F16
?	—	F 1 7	F17
1	1	F 1 8	F18
2	2	F 1 9	F19
3	3	F 2 0	F20
4	4		
5	5		
6	6		
7	7		
8	8		
9	9		
0	0		
*	*		
#	#		
		+	F/W ( CNF )
		—	B/W ( RECALL )
		CTRL & E	ENTER ( ANS )
		SHIFT & DEL BS	CLEAR ( HOLD )
		CTRL & D	ON-HOOK ( SPKR )
		CTRL & N	TEL# ( TFR )
		@	OFF-HOOK ( SPKR )
		\$	

NOTE: When two keys are separated by an & sign, this indicates that two keys should be depressed simultaneously.

Type: F6 ← (RETURN) (To enter Line Key Assignment Mode).

Display shows:

```

LINE KEY ASSIGN
TEL ???
<OFF HOOK>
LK 1 5 9 13
-----
F 6
    
```

Type: 202 ← (Return) (To enter EXT number being programmed).

Display shows:

```

LK ASGN TEL 102
SELECT LINE KEY
<OFF HOOK>
LK 1 5 9 13
-----
102
    
```

Type: L1 ← (Return) (To enter Line Key number 1 to be programmed).

Display shows:

```

LK ASGN TEL102
CO-01
<OFF HOOK>
LK 1 5 9 13
-----
L1
    
```

Type: F14 ← (Return) (To select line type as EXT).

Display shows:

```

LK ASGN TEL102
EXTENSION - ???
<OFF HOOK>
LK 1 5 9 13
-----
F 14
    
```

Type: 100 ← (Return) (To select EXT number 100).

Display shows:

```

LK ASGN TEL102
EXTENSION - 100
<OFF HOOK>
LK 1 5 9 13
-----
100
    
```

While holding down the CTRL key, depress E. (To enter information into the Electra MarkII program memory). System automatically advances to LK2.

Display shows:

```

LK ASGN TEL102
CO-02
<OFF HOOK>
LK 1 5 9 13
-----
    
```

Type: F18 ← (RETURN) (To select line type as Save & Repeat).

Display shows:

```

LK ASGN TEL102
SAVE & REPEAT - ??
<OFF HOOK>
LK 1 5 9 13
-----
F 18
    
```

Type: 01 ← (RETURN) (To select Save & Repeat buffer 1).

Display shows:

```

LK ASGN TEL102
SAVE & REPEAT - 01
<OFF HOOK>
LK 1 5 9 13
-----
01
    
```

While holding down the CTRL key, depress E. (To enter information into the Electra MarkII program memory). System automatically advances to LK3.

Display shows:

```

LK ASGN TEL102
CO-03
<OFF HOOK>
LK 1 5 9 13
-----
    
```

Type: F20 ← (RETURN) (To select line key function as DND position).

Display shows:

```

LK ASGN TEL102
DND POSITION
<OFF HOOK>
LK 1 5 9 13
-----
F 20
    
```

While holding down the CTRL key, depress E. (To enter information into the Electra MarkII program memory). System automatically advances to LK4.

Display shows:

```

      LK ASGN  TEL102
      CO-04
                <OFF HOOK>
LK   1       5       9       13
    ---□-----
  
```

At this time you may continue programming other features or exit program mode by going on-hook (CTRL-D).

**NOTE:** The programmer must go on-hook (CTRL-D) before terminating the communication link. Failure to do so results in the port associated with the RAA-E to remain busy and if the PC was in program mode, the other programming stations will not be able to go into program mode.

#### 940.5 IBM type COMPATIBLE VERSION SOFTWARE

##### A. EQUIPMENT REQUIRED:

**NOTE:** The modem must be capable of executing the Hayes® Command Set.

1. IBM XT, IBM AT, NEC Multispeed, or an NEC APC IV must be locally provided.

**NOTE:** The IBM type version RAA software will run on either a 1.2 mb high density disk drive or a 360 kb low density disk drive.

2. IBM RAA version diskette (available on either a 5.25" or a 3.5" diskette).

3. Operating system on the IBM XT, IBM AT, NEC Multispeed, or NEC APC IV has to be MS-DOS® (Equivalent to NEC APC IV MS-DOS 3.2)

4. Refer to Sections 9.10.4 - 920.6 and Figure 910.1 for RS-232C cables, modem, and block diagram information, etc.

##### B. EXECUTING IBM TYPE COMPATIBLE SOFTWARE

1. Insert the RAA disk into the available drive. Ensure drive prompt is for the drive that the RAA disk is in and enter COMLINK.

2. Depress ← (Return).

Display shows:

```

      NEC Remote Administrator
      Terminal Emulator Ver 1.0
      Caps lock key must be set on
      Press any key to continue _
  
```

3. Depress any key (Caps lock must be on). Display shows:

```

      RAA TERMINAL EMULATOR
      Are You Using a Modem (Y/N)
      : \> _
  
```

4. Enter Y for Yes or N for No so that you will be able to access the modem screen when needed. If you enter Y, the display shows:

```

      RAA TERMINAL EMULATOR
      Are you using a Modem (Y/N)
      Select System
      A : Electra IMS
      B : Electra MarkII
      : \> Y
  
```

5. If you select system B (Electra MarkII). Type B. Display shows:

```

      RAA TERMINAL EMULATOR
      Are you using a Modem (Y/N)
      Select System
      A : Electra IMS
      B : Electra MarkII
      Select Com Port
      A) Com 1   B) Com 2
      : \> B
  
```

6. Select COM PORT which applies to your configuration (A or B).

For example, type A.

Display shows:

```

      RAA TERMINAL EMULATOR
      A : Electra IMS
      B : Electra MarkII
      Select Com Port
      A) Com 1   B) Com 2
      Select Baud Rate
      A : 2400 Baud B : 1200 Baud
      C : 600 Baud D : 300 Baud
      : \> A
  
```

7. Select baud rate (A, B, C, or D). Ensure that the baud rate selected matches the baud rate of the modems and that of the RAA-E unit.  
Display shows: (If modem is used, otherwise see display in step 10 and continue from there.)

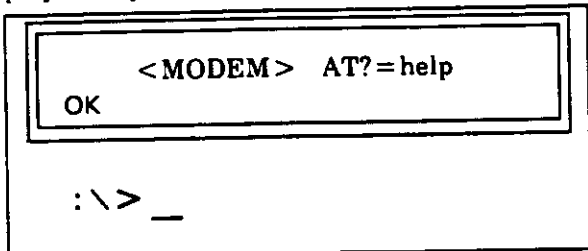

8. Enter ATDT\* followed by the telephone number for the modem associated with the RAA-E at the job site and depress ←(RETURN) (EX: ATDT 7530093 ←(RETURN))  
a) Modem will go off line and will dial the telephone number entered.  
Display shows:

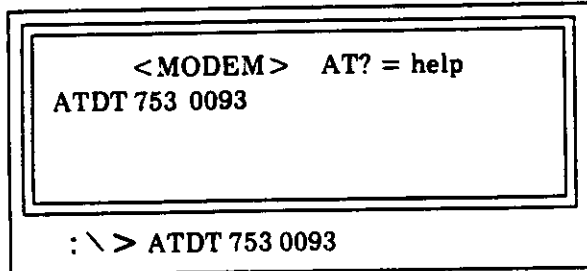

b) Carrier tone is received and a connection is made.

(If left in this mode, the time and date will appear in the screen. Example 11:58)

\* Assumes modem is connected to DTMF Telco line.

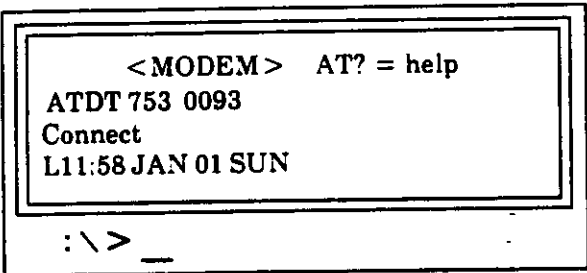

9. Enter ATO and depress ←(RETURN). Computer screen returns to the RAA display. (Depressing the ESC key at any time during programming brings up the modem screen; depressing the ALT H at any time during programming brings up the help screen).

**NOTE:** After returning to the RAA screen the time will appear approximately in one minute, but you can start programming immediately.

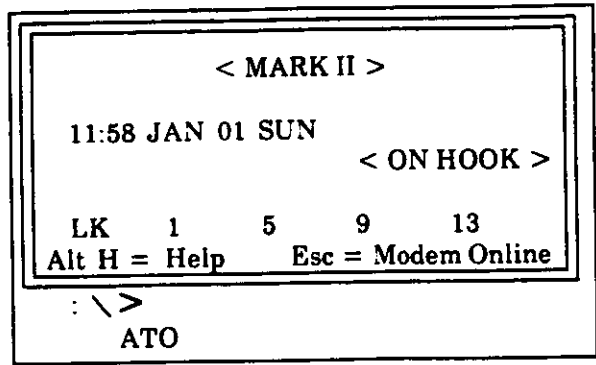

10. Depress @ to go off-hook.  
Display shows:

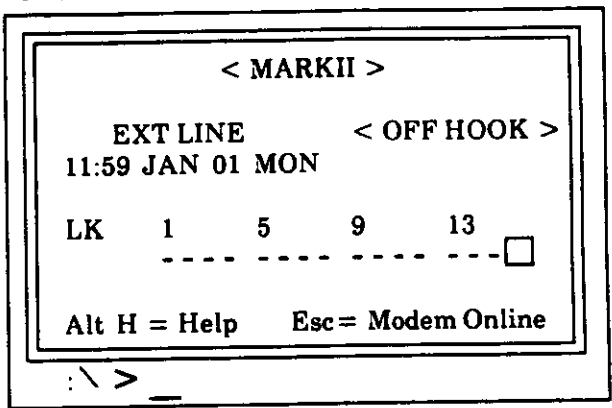

If no modems are used (direct connection).  
Display shows:

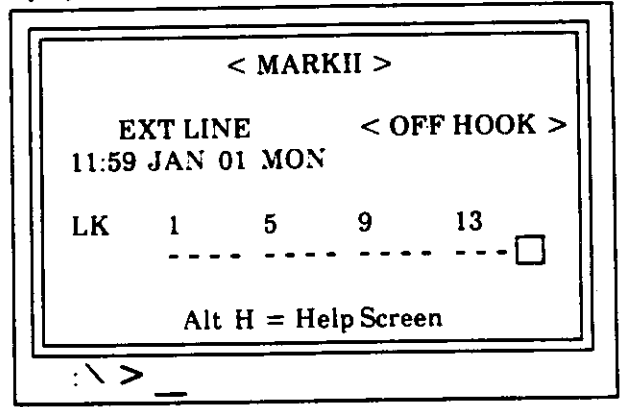

**NOTE:** The following display indications are provided on the computer when used for remote administration:

- Line key in use - green - steady
- X - Line key flashing
- \* - Line key in use - red- steady
- - Line key is idle

11. Depress #, \*, 0 and ← (RETURN) to go off-line (Program Mode). Program as you would with a ETE-16D-1. Depressing the Alt H shows the keystroke depressions needed for proper programming. (Help Screen).

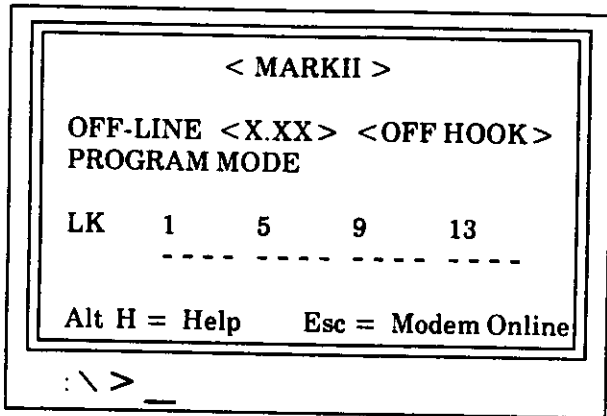

12. To exit the RAA terminal emulator program follow this procedure:

1. Insure that the RAA is ON-HOOK.
2. Depress ESC once to get to the modem screen and wait a few seconds until OK appears on the screen.
3. Depress ESC again and the program will prompt you with the following display:

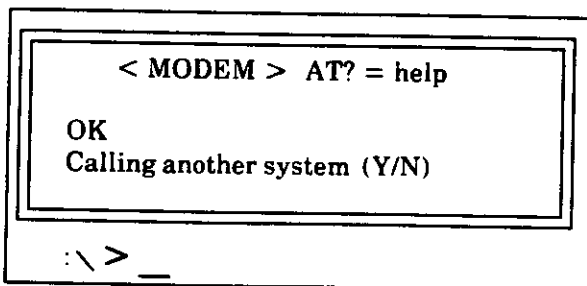

4. Enter Y (yes) if calling another modem or N (no) if not.
  - a. If you depress Y go back to step 3 and continue from there.
  - b. If you depress N the prompt will indicate the following:

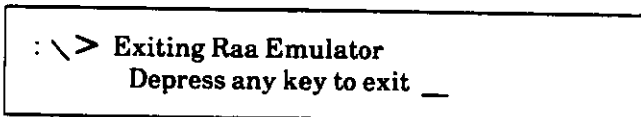

Upon depression of any key the modem connection is terminated and the computer boots MS-DOS®.

**NOTES:** 1. Anytime you depress ? on the PC whether in idle or program mode, a SELF CHECK OK !!! display is received. This verifies the modem and the RAA-E are communicating.

2. Anytime you depress ESC on the Computer, whether in idle or program mode, a CONNECT XXXX (BAUD RATE CHOSEN) ←(RETURN) display is received. This verifies the modem and/or PC and the RAA-E are communicating.

3. After SELF CHECK is performed, depress ←(RETURN) to return to the programming screen. Once you are in a memory block, and a self check is performed, an ALARM 1 is received if another function is attempted before ←(RETURN) is depressed.

#### 940.6 GENERAL PROGRAMMING NOTES

In the above example entering information to the RAA-E unit is done as follows: type F1, depress ←(RETURN) to enter information to the RAA-E unit; type F9, depress ←(RETURN) to enter the information, etc. Another means of entering consecutive Function Button numbers or Line Button numbers in program mode is available. Instead of entering F1 ←(RETURN) then F9 ←(RETURN) then F17 ←(RETURN) (Class of Service Assignment), you can enter up to 16 characters by using only the first F or L in the string of numbers and inserting a comma (,) after each item to send the information to the RAA-E, therefore the same information could be entered as F1, 9, 17 ←(RETURN). Once a ←(RETURN) is used, you must enter another F or L to begin another string. Another example of entering line button assignments while in the Line Key Assignment, Memory Block (F1, F6) is as follows: the line button assignments can be checked by typing L1 ←(RETURN) then L2 ←(RETURN) then L3 ←(RETURN) etc. A fast method would be L1, 2, 3, etc. while viewing each assignment every time the comma is used.

When assigning a name in Memory Block 3C, an ! must be entered as a lead character in front of the name being assigned. The ! tells the PC-8300 that what follows is an alphabetic string instead of a command. Once the new name is typed, depress ←(RETURN) to enter the name in the display followed by a CTRL-E which enters the name in memory. If more characters are entered, ALARM 1 is displayed and the extra character is not accepted.