

ALIENCHASE

Radio Shack

Catalog Number 60-2186

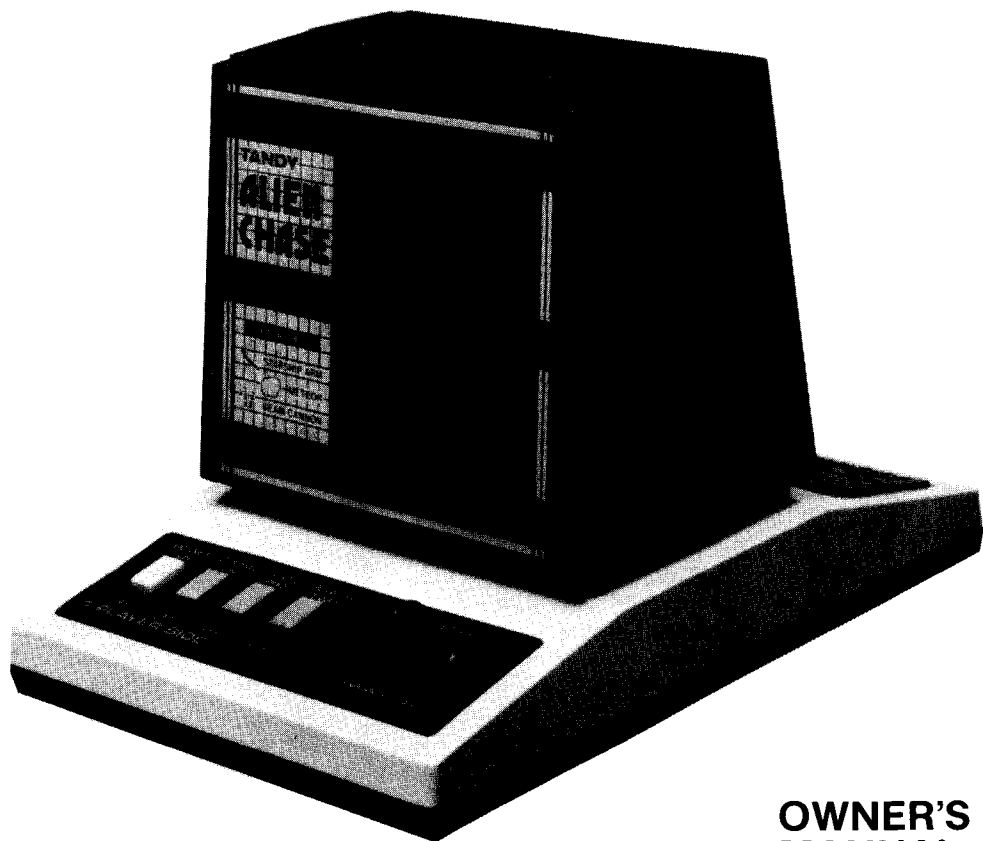

**OWNER'S
MANUAL**

Video Game for One or Two Players

CUSTOM MANUFACTURED FOR RADIO SHACK, A DIVISION OF TANDY CORPORATION

You'll have hours of fun-filled adventure
with your Video Game
chasing Aliens in outer space.
But first you have to get ready for combat.

POWERING UP

Loading the Batteries

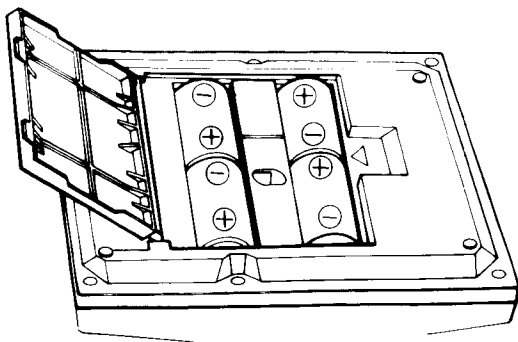

Be sure the POWER Switch is turned off. Turn the Video Game upside down and lift the battery cover. Install four size C batteries as shown in the diagram. We suggest Radio Shack batteries Catalog Number 23-581 or 23-551 for proven performance. The Video Game will work properly depending on how it is switched on. If it does not work at first, turn the POWER Switch off, and turn it on again.

AC Adapter

Your game can also be powered by plugging it into a household electrical outlet. (Be sure to remove batteries from the game, before using this second source of power. There's no sense in wasting them.) Radio Shack's Adapter, Catalog Number 273-1650, is compatible with this game.

Use the green plug, select 6V position, and set center tip negative.

- First — insert the AC Adapter plug into the jack as illustrated.
- Second — insert the wall plug of the adapter into the electrical socket.
- If you do this backwards, you could get a shock!

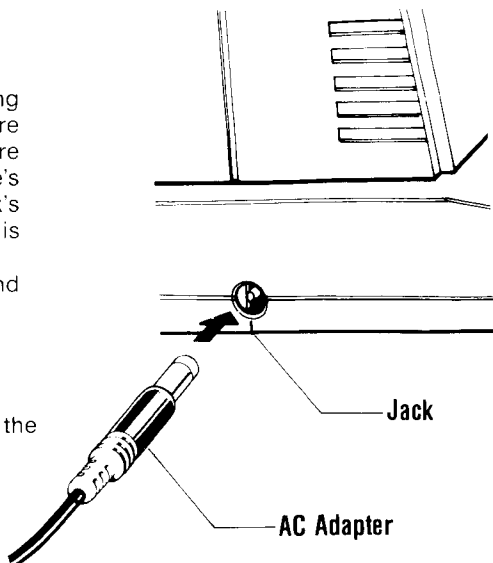

INSTRUMENT CHECK

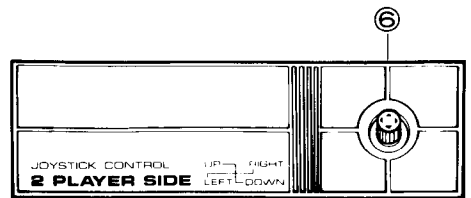
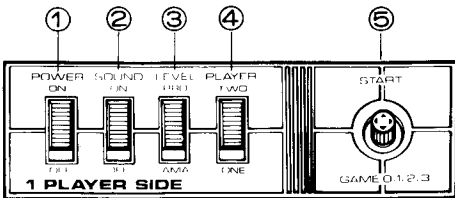
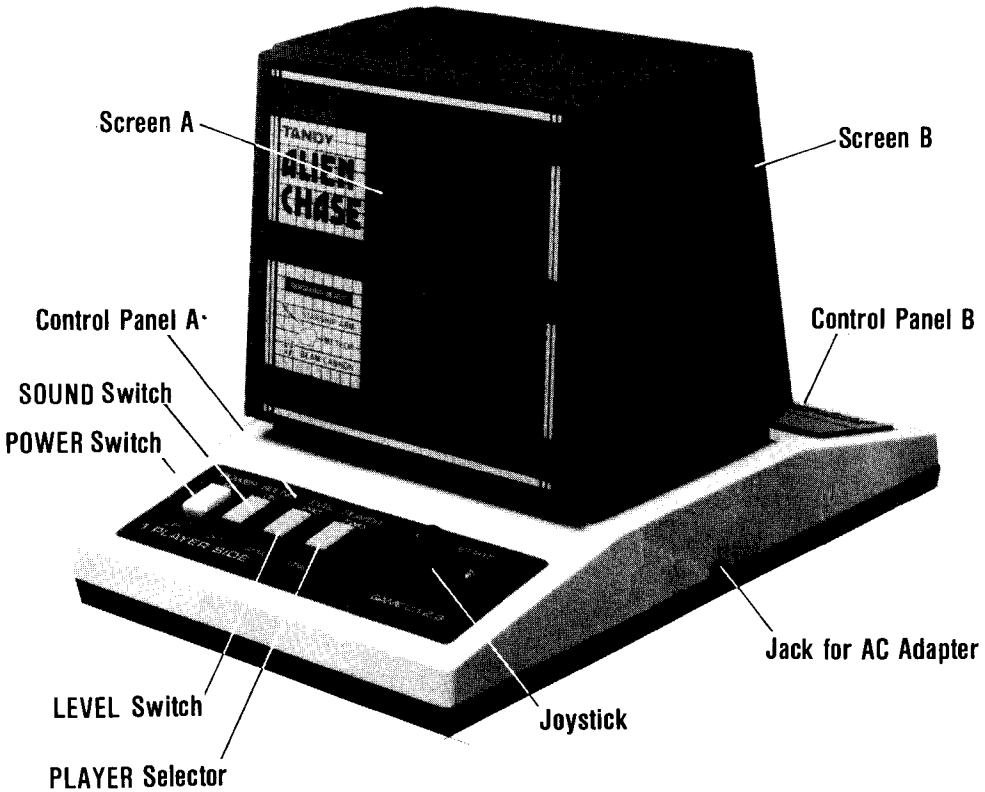

- ① POWER Switch..... Turns the game on and off
- ② SOUND Switch..... Turns the sound on and off
- ③ LEVEL Switch..... Selects level of skill
- ④ PLAYER Selector..... Selects two players or one against the computer
- ⑤ Joystick Control..... At beginning of game selects game pattern and starts the game.
Also controls Astronaut of 1st player.
- ⑥ Joystick Control..... Controls Astronaut of 2nd player.

PRE-FLIGHT BRIEFING

Dangerous Encounters



Alien Spaceship

Watch out for the moving arms. They'll knock you back to your base, and you'll have to start again.



Aliens

They're slippery devils. They sneak out of the underbelly of the spaceship and pull all kinds of tricks to get away from you. They'll try hiding anywhere — even inside a meteorite. And they have to be captured!

Beam Guns

There are two beam guns installed at each base. If you get in the line of fire at your opponent's base, you'll be knocked back to base. The Alien flies away, and you have to start after him again. Try to steal the alien while the gun is pointed away from you.

Meteorites

The first time you see them, they won't budge an inch. Go around them quickly. If you run into one, you'll be thrown back to base. The next time you see them, they move all over the place. You have to pull even trickier moves to get around them.



MISSION

Capture all the Aliens.

The Astronauts are the only ones who can capture the Aliens. You're the red Astronaut anytime you use the front control board.

One Player

The other Astronaut is your opponent. You have to be fast on the moves. When you play alone, this Astronaut is maneuvered by the computer.



Two Players

When two are competing, the player using the joystick on the back of the game controls this Astronaut's moves.



Bases

Home base is at the bottom of the screen for the front controls and at the top of the screen for the back controls when two are playing. The top of the screen is the computer's home base when you're playing solo.

When the hatch opens, move the joystick up or down (depending on whether your base is at top or bottom) to lock the Alien inside. You can see the Alien in the home base. But as soon as you capture one, another Alien sneaks out the spaceship.

SOLO

Turn the POWER Switch on, and you'll see...

One Player

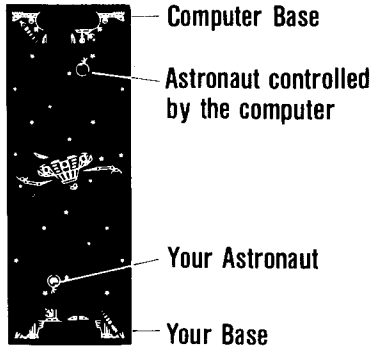

Move the switches to the positions you want for SOUND, the number of PLAYERS, and LEVEL. It's a good idea to start off with an AMateur stauts then graduate to PROfessional.

BLAST OFF

Move the joystick up to start the combat.

Move the joystick left to get the Astronaut to the left side of the screen — move it right to get to the right side — down to move down — and up to move up. Wherever the Alien moves, you give chase. Get on the same line, and the Alien is captured in your magnetic field and can now be taken to your home base.

Snatching the Alien away

WATCH OUT! The rival Astronaut can meet you head on and snatch the Alien from you.

On a solo flight you move through three phases of play automatically — each more suspenseful than the last. In phase one — there are only the twinkling stars. They don't threaten you. But in phase two you have to fly around the meteorites to keep from crashing back to home base. In phase three the meteorites move and are even tougher to avoid.

Levels of play

As you grow more skillful in astral warfare, you may wish to skip the beginning levels of combat. You can jump right to the second or third level if you wish. Before you move the joystick to START, move it down twice for the meteorite display — move it down three times for the moving meteorites.

The Winner

The first Astronaut to get seven Aliens inside home base wins the game!

DUAL COMBAT

Two Players

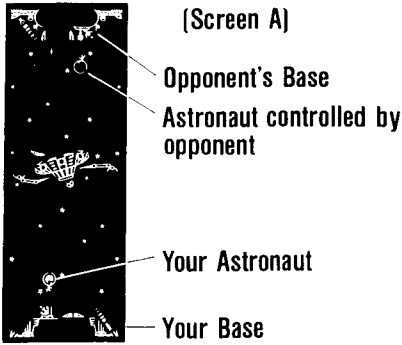

(Screen A)

Opponent's Base
Astronaut controlled by opponent

Your Astronaut

Your Base

Your Base 1st Player's Side

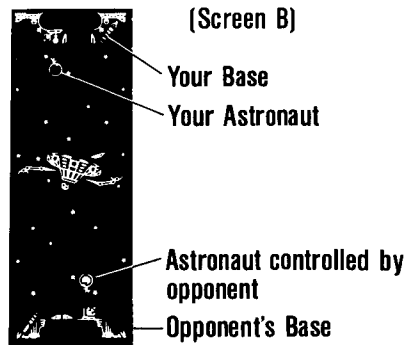

Your Base 2nd Player's Side

(Screen B)

Your Base





Your Astronaut

Astronaut controlled by opponent

Opponent's Base

When an Astronaut captures an Alien, he must then take him to his own Base. It is possible for the rival Astronaut to snatch the Alien away from him en route.

- If you go to the same spot as the opposing Astronaut, the Alien is passed over to your side.
- Snatching away Aliens is possible at any time until the Alien is placed inside the Base.
- * When an Astronaut with a captive Alien runs into a Meteorite, Spaceship arm, or a Beam Gun, the Alien gets away and the Astronaut is moved back to his starting position.

<p>Back Panel Player</p> <p style="text-align: center;">▼</p> <div style="display: flex; align-items: center; justify-content: center;"> <div style="writing-mode: vertical-rl; transform: rotate(180deg);">Starting Position</div>  <div style="writing-mode: vertical-rl; transform: rotate(180deg);">Starting Position</div> </div> <p style="text-align: center;">▲</p> <p>Front Panel Player</p>	 <p>■ Game 1: The Alien appears from its Spaceship. Maneuver your Astronaut to capture the Alien and carry it to your Base while skillfully moving out of the way of your opponent. The first player to capture seven aliens wins game 1.</p>	 <p>■ Game 2: The Meteorites remain stationary in space. Try to capture the Aliens while staying clear of these Meteorites. The player capturing seven aliens first, wins game 2.</p>	 <p>■ Game 3: The Meteorites are in motion in space. Skillfully avoid running into them as you try to capture the Aliens. Whoever captures seven aliens first wins game 3.</p>
---	--	--	---

MAINTENANCE

This game uses high-precision components of a microcomputer and fluorescent indicators. Always keep the following precautions in mind.

1. When using an AC adapter, be sure to use Radio Shack Catalog Number 273-1650. Any other kind of adapter should not be used.
2. Replace all of the batteries with new ones whenever any of the following occurs:
 - Display illumination fails to operate properly
 - The illumination grows dim
 - Parts of the screen go off
3. Do not put the game near electric appliances such as on top of the TV set, microwave oven, etc.
4. Be careful not to get juice or other beverages, or cookie crumbs or other food particles inside the game.
5. Clean the surface of the game with a dry cloth. (Volatile liquids such as paint thinners and polish remover should never be used.)
6. Do not leave the game for lengthy periods in direct sunlight, or expose it to extremes of temperature.
7. Never take the game apart or drop it.



RADIO SHACK LIMITED WARRANTY

This product is warranted against defects for 90 days from date of purchase from Radio Shack company-owned stores and authorized Radio Shack franchisees and dealers. Within this period, we will repair it without charge for parts and labor. Simply **bring your Radio Shack sales slip** as proof of purchase date to any Radio Shack store. Warranty does not cover transportation costs. Nor does it cover a product subjected to misuse or accidental damage.

EXCEPT AS PROVIDED HEREIN, RADIO SHACK MAKES NO WARRANTIES, EXPRESS OR IMPLIED, INCLUDING WARRANTIES OF MERCHANTABILITY AND FITNESS FOR A PARTICULAR PURPOSE. Some states do not permit limitation or exclusion of implied warranties; therefore, the aforesaid limitation(s) or exclusion(s) may not apply to the purchaser.

This warranty gives you specific legal rights and you may also have other rights which vary from state to state

We Service What We Sell

www.handheldmuseum.com

RADIO SHACK, A DIVISION OF TANDY CORPORATION

U.S.A.: FORT WORTH, TEXAS 76102
CANADA: BARRIE, ONTARIO L4M 4W5

TANDY CORPORATION

AUSTRALIA

280-316 VICTORIA ROAD
RYDALMERE, N. S. W. 2116

BELGIUM

PARC INDUSTRIEL DE NANINNE
5140 NANINNE

U. K.

BILSTON ROAD WEDNESBURY
WEST MIDLANDS WS10 7JN

“To choose the Game Pattern, press the Control Lever down. The number of Aliens in the Base at the bottom of the screen indicates the game number (Game 0, 1, 2, 3), as shown in the illustrations below. After you have selected your game, push upward on the Control Lever to start the game.

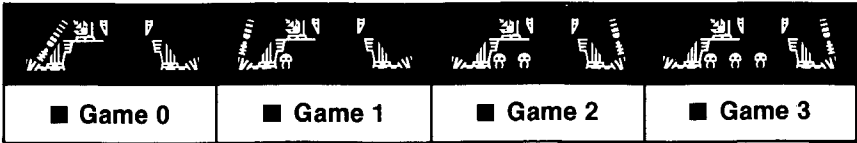

Game 0

Game 0 is a combination of Games 1, 2, and 3. The Alien appears from its Spaceship. Maneuver your Astronaut to capture the Alien and carry it to your Base. Game 1 appears first, and continues until 3 Aliens are captured by either Astronaut. Then the screen proceeds to Game 2, and stationary Meteorites appear. After 3 Aliens are captured by both of the Astronauts, or 6 Aliens are captured by one of the Astronauts, Game 3 begins. The Meteorites begin to move. The first player to capture 7 Aliens wins Game 0.”